



# **WAMBO SURFACE WATER MANAGEMENT PLAN**

Document No. WA-ENV-MNP-509.2  
November 2023

## Document Control

<b>Document No.</b>	WA-ENV-MNP-509.2
<b>Title</b>	Wambo Surface Water Management Plan
<b>General Description</b>	Surface Water Management at Wambo Coal Mine and Coal Handling Facilities
<b>Document Owner</b>	WCPL Environment & Community Manager

## Revisions

Rev No	Date	Description	By	Checked	Signature
1	August 2020	New Surface Water Management Plan (Version 1) for Wambo Mine, following approval of DA305-7-2003 (Modification 16) & DA177-8-2004 (Modification 3). Replaces the Wambo Surface Water Monitoring Program (Version 12).	WCPL	CB	
2	November 2020	Changes to address minor comments from DPIE	WCPL		
3	November 2023	Update to address DPE and DPE-Water comments on the LW24-26 EP and changes to monitoring program	WCPL		

## CONTENTS

<b>1.0</b>	<b>INTRODUCTION.....</b>	<b>1</b>
1.1	PURPOSE AND OBJECTIVES .....	1
1.2	SCOPE .....	1
1.3	RELATIONSHIP TO OTHER MANAGEMENT PLANS .....	3
1.4	PREPARATION OF THE SWMP .....	4
1.5	STAKEHOLDER CONSULTATION .....	4
1.6	STATEMENT OF COMMITMENTS .....	5
<b>2.0</b>	<b>STATUTORY REQUIREMENTS .....</b>	<b>6</b>
2.1	LEGISLATION, POLICIES, GUIDELINES AND STANDARDS .....	6
2.2	DA305-7-2003 CONDITIONS OF CONSENT .....	6
2.3	DA177-8-2004 CONDITIONS OF CONSENT .....	10
2.4	EPL 529 CONDITIONS .....	10
2.5	INDEPENDENT ENVIRONMENTAL AUDIT RECOMMENDATIONS .....	11
2.6	SURFACE WATER LICENCE CONDITIONS .....	11
2.7	ADDITIONAL REGULATOR REQUIREMENTS .....	13
<b>3.0</b>	<b>EXISTING ENVIRONMENT AND BASELINE DATA .....</b>	<b>14</b>
3.1	EXISTING ENVIRONMENT .....	14
3.2	WATER SUPPLY FOR SURFACE WATER USERS .....	17
3.3	SURFACE WATER MONITORING NETWORK .....	17
3.4	REVIEW OF BASELINE DATA .....	20
3.5	SITE WATER BALANCE .....	29
<b>4.0</b>	<b>IMPACT ASSESSMENT AND PERFORMANCE CRITERIA .....</b>	<b>30</b>
4.1	SURFACE WATER IMPACT ASSESSMENT CRITERIA .....	30
4.2	SURFACE WATER PERFORMANCE CRITERIA .....	32
<b>5.0</b>	<b>SURFACE WATER MANAGEMENT MEASURES .....</b>	<b>34</b>
5.1	SITE WATER MANAGEMENT SYSTEM .....	34
5.2	WATER SUPPLY AND WATER SHARING .....	37
5.3	PRESCRIBED DAMS AND TAILINGS .....	37
5.4	SEWAGE TREATMENT PLANT OPERATION AND MAINTENANCE .....	38
5.5	CHEMICAL AND HYDROCARBON STORAGE .....	38
5.6	EROSION AND SEDIMENT CONTROL .....	38
5.7	ANNUAL SITE WATER BALANCE AND SALT BALANCE .....	38
5.8	MANAGEMENT OF THE LOCOMOTIVE PROVISIONING FACILITY .....	39

5.9	DECOMMISSIONING OF WATER MANAGEMENT STRUCTURES.....	40
5.10	INSPECTIONS.....	40
5.11	AUDITING.....	40
<b>6.0</b>	<b>SURFACE WATER MONITORING PROGRAM.....</b>	<b>41</b>
6.2	SAMPLING METHODOLOGY.....	49
6.3	DATA MANAGEMENT PROCEDURES.....	50
6.4	DATA REVIEW AND INVESTIGATION.....	50
<b>7.0</b>	<b>SURFACE WATER RESPONSE PLAN.....</b>	<b>51</b>
7.1	ADAPTIVE MANAGEMENT.....	51
7.2	INCIDENT DEFINITION.....	51
7.3	IMPACTS ON SURFACE WATER.....	51
7.4	FAILURE TO COMPLY WITH OTHER STATUTORY REQUIREMENTS.....	59
<b>8.0</b>	<b>COMMUNITY COMPLAINT RESPONSE.....</b>	<b>60</b>
<b>9.0</b>	<b>REVIEW AND REPORTING.....</b>	<b>61</b>
9.1	REVIEW.....	61
9.2	REPORTING.....	61
<b>10.0</b>	<b>RESPONSIBILITIES.....</b>	<b>63</b>
<b>11.0</b>	<b>REFERENCES.....</b>	<b>64</b>
	<b>APPENDIX A: EVIDENCE OF CONSULTATION.....</b>	<b>65</b>
	<b>APPENDIX B: SWMP SUMMARY OF COMMITMENTS.....</b>	<b>72</b>
	<b>APPENDIX C: EPL CONDITIONS RELEVANT TO THIS SWMP.....</b>	<b>77</b>
	<b>APPENDIX D: NORTH WAMBO CREEK DIVERSION MANAGEMENT PLAN.....</b>	<b>86</b>

## Tables

Table 1: DA305-7-2003 Requirements for this SWMP.....	7
Table 2: DA305-7-2003 Surface Water Management Performance Measures.....	9
Table 3: DA177-8-2004 Surface Water Management Performance Measures.....	10
Table 4: 2017 IEA Recommendations relevant to this SWMP.....	11
Table 5: Surface Water Licences for United and Wambo .....	12
Table 6: Additional Surface Water Monitoring Program Requirements .....	13
Table 7: Catchment Areas of Local Creeks* .....	17
Table 8: Surface Water Monitoring Locations .....	18
Table 9: Surface Water Quality Ranges – Local Watercourses.....	21
Table 10: Stream Flow Monitoring Data Summary .....	22
Table 11: Stream Flow Summary for Historical Monitoring Sites .....	25
Table 12: North Wambo Creek – Baseline Assessment Hydraulic Model Results* .....	27
Table 13: Discharge Limits and Requirements.....	30
Table 14: Surface Water Flow Impact Assessment Condition .....	31
Table 15: Surface Water Quality Impact Criteria .....	31
Table 16: Surface Water Performance Criteria.....	32
Table 17: Performance Indicators.....	33
Table 18: Diversion and Subsidence Monitoring Program – Operational Monitoring.....	46
Table 19: TARP for Impacts on Surface Water Flows .....	53
Table 20: TARP for Impacts on Surface Water Quality.....	54
Table 21: TARP for Breach of EPL 529 Limits .....	55
Table 22: TARP for Impacts on North Wambo Creek Alluvium .....	56
Table 23: TARP for North Wambo Creek Diversion Performance .....	57
Table 24: SWMP Responsibilities.....	63

## Figures

Figure 1: Approved Wambo Coal Mine – Phase 2 .....	2
Figure 2: Wambo Water Management Plan.....	3
Figure 3: Wollombi Brook Catchment Context.....	15
Figure 4: Project Area Catchment Context.....	16
Figure 5: Wambo Surface Water Monitoring Locations .....	19
Figure 6: Flow Duration Curves Wollombi Brook Upstream and Downstream of the Mine .....	24
Figure 7: Recorded Daily Rainfall and Flow/No Flow Days – North Wambo Creek at FM2 .....	25
Figure 8: Recorded Daily Rainfall and Flow/No Flow Days – North Wambo Creek at FM4 .....	25
Figure 9: Extents of North Wambo Creek .....	28
Figure 10: Water Management System (Jacobs, 2020) .....	36
Figure 11: Diversion and Subsidence Monitoring Locations .....	48

## 1.0 Introduction

### 1.1 Purpose and Objectives

This Surface Water Management Plan (SWMP) has been developed by Wambo Coal Pty Ltd (WCPL) to address the relevant requirements of WCPL's development consents DA305-7-2003 and DA177-8-2004 (as modified), as relevant to Phase 2 mining operations at the Wambo Coal Mine (Wambo). This SWMP also addresses the relevant conditions of Environmental Protection Licence (EPL) 529.

The key objectives of surface water management at Wambo are to:

- satisfy regulatory requirements, including meeting required performance criteria;
- ensure there are negligible impacts to adjacent surface water users (both consumptive users and the environment);
- reuse mine impacted water within the WMS to reduce reliance on raw/clean water; and
- minimise adverse effects on downstream waterways (including hydraulic and water quality impacts).

This SWMP has also been prepared in accordance with Condition D5 of DA305-7-2003 (Management Plan Requirements).

### 1.2 Scope

This SWMP applies to all Phase 2 operational activities at the Wambo Coal Mine, including underground mining operations, CHPP and train loading operations (**Figure 1**). It does not apply to open cut mining operations associated with the United Wambo Open Cut Project.

This SWMP applies to all employees and contractors working for, or on behalf of WCPL within the project approval boundary (**Figure 1**).

This SWMP covers all surface water management activities undertaken within Wambo's mining authorisations and approved mining areas. This SWMP has been prepared to manage surface water impacts from Wambo on local surface water systems.

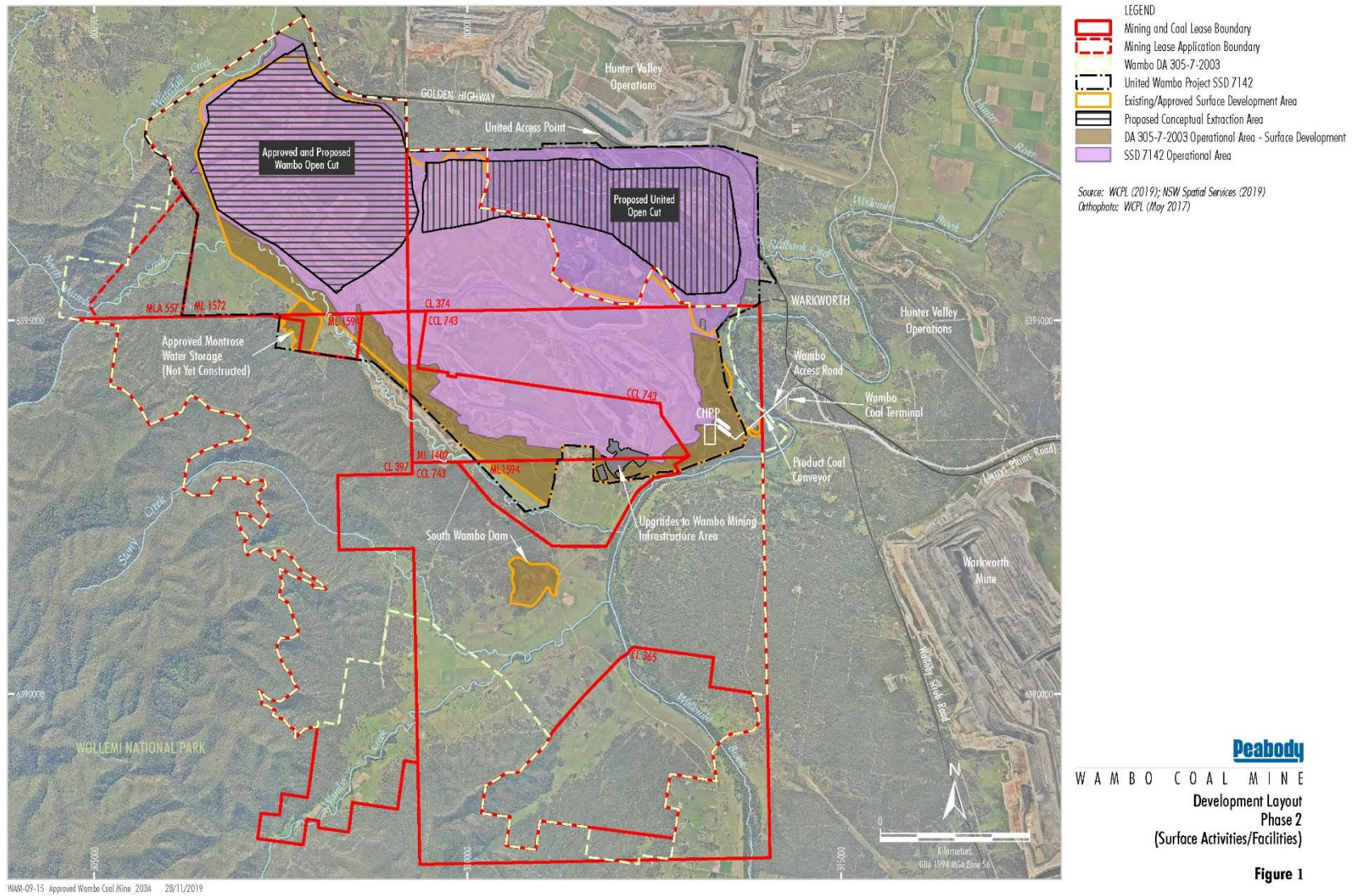

**Figure 1: Approved Wambo Coal Mine – Phase 2**

### 1.3 Relationship to other Management Plans

This SWMP is part of a set of documents that together form the WCPL Water Management Plan (WMP) for the Wambo Coal Mine (**Figure 2**). The WMP is one of a series of Environmental Management Plans that together forms part of the WCPL Environmental Management System.

As part of Phase 2 operations, WCPL has combined the surface and ground water monitoring programs at Wambo with the United Wambo Open Cut surface and ground water monitoring programs. This combined monitoring program is now contained within the new **United Wambo Open Cut and Wambo Water Monitoring Program (WMProg)** (WA-ENV-MNP-509.8). A brief description of WCPL’s surface water monitoring program is included in **Section 6.0** of this SWMP however the monitoring program itself is now included in the **WMProg**.

As part of the United Wambo Open Cut Project Environmental Assessment (Umwelt 2016), WCPL’s site water balance (and salt balance) was expanded to include the United Wambo Open Cut project. The **United Wambo Open Cut and Wambo Site Water Balance (SWB)** (WA-ENV-MNP-509.4) is now a shared document, managed by WCPL. The **SWB** also contains the salt balance will be updated annually using monitoring data from the **WMProg**.

This SWMP should be read in conjunction with the other components of the Water Management Plan, particularly the overarching Wambo **Water Management Plan** (WA-ENV-MNP-509), **WMProg** (WA-ENV-MNP-509.8) and the Wambo **Environmental Management Strategy (EMS)** (WA-ENV-MNP-501).

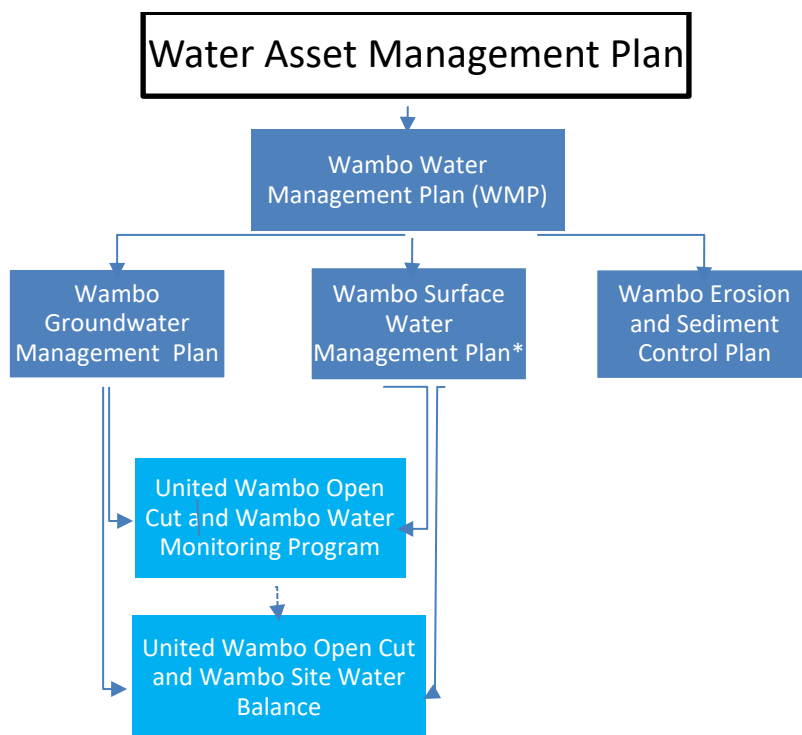

Figure 2: Wambo Water Management Plan

Notes to **Figure 2**:

  Shared Document with United Wambo Open Cut Operations (refer Table 2 of **WMP**)

  Wambo Document (refer Table 2 of **WMP**)

\* SWMP incorporates the **North Wambo Creek Diversion Management Plan (NWCD MP)** – refer **Section 1.3.1**



### 1.3.1 Obsolete Plans

Prior to Modification 16 of DA305-7-2003, WCPL was required to prepare a **Surface and Groundwater Response Plan (SGWRP)** for the Wambo Coal Mine, and a **North Wambo Creek Diversion Management Plan (NWCD MP)** for management of the North Wambo Creek Diversion.

The **SGWRP** detailed WCPL's response to observed impacts on surface and ground water as a result of WCPL's operations. Following approval of Modification 16, the Surface Water Response Plan has now been incorporated into this SWMP (refer **Section 7.0**). The Groundwater Response Plan has been incorporated into the **GWMP**.

The **NWCD MP** is no longer required by consent (DA305-7-2003, Modification 16) however, due to the complexities associated with the diversion and also the history of consultation on this plan, WCPL has retained the **NWCD MP** as a standalone plan at this stage (refer **Appendix D**). The status of this plan will be reviewed during future SWMP updates.

## 1.4 Preparation of the SWMP

In recognition of the requirements of Condition B66(a) of DA305-7-2003, this SWMP prepared by WCPL has been reviewed by a suitably experienced and qualified persons. Mr Chris Bonomini from Umwelt was endorsed 2 September 2020. Mr Rohan Lucas from Alluvium Consulting also remains endorsed, and will assist with rehabilitation and remediation works in the North Wambo Creek Diversion (refer **Section 1.5.2** regarding NSW Department of Planning and Environment (DPE)).

## 1.5 Stakeholder Consultation

### 1.5.1 History of Consultation

There is a long history of consultation with various stakeholders regarding WCPL's Water Management Plan. Over the years WCPL has undertaken extensive consultation with government agencies, the Wambo Community Consultative Committee (CCC) and affected landholders in relation to management plan updates, including for various extraction plans.

Prior to the approval of DA305-7-2003 Modification 16 (in August 2019), this consultation was undertaken for WCPL's Surface Water Monitoring Program. The last update to the WCPL Surface Water Monitoring Program (version 12) was undertaken in consultation with DPE, as part of the Extraction Plan for South Bates Underground Extension LW17-20. This update addressed comments from the DPE and Independent Expert Scientific Committee (IESC) and built on consultation undertaken on previous versions of the document.

A summary of historic consultation, including how comments from DPIE Water, the IESC and DPE have been addressed in previous versions of the SWMP, is provided in **Appendix A**.

### 1.5.2 Consultation for this SWMP

On 11 February 2020 WCPL sought approval from DPIE for the appointment of Mr Rohan Lucas as the suitably qualified surface water expert for the preparation of the South Bates Underground Extension (SBUE) Extraction Plan for Longwalls 21-24. Mr Lucas was approved by DPIE on 28 February 2020 (refer to correspondence in **Appendix A**). On 29 May 2020, DPIE confirmed that Mr Lucas was suitably qualified to assist in the preparation of the management plans.

On 3 August 2020 WCPL wrote to DPIE and requested endorsement for Mr Bonomini, to assist in the preparation of the other water management plans required under the Consent. Mr Bonomini was endorsed 2 September 2020.

Following the commencement of Phase 2 operations at the Wambo Coal Mine, the SWMP was revised as Version 1. As required by Condition B66 (b) of DA305-7-2003, WCPL must prepare this SWMP in consultation with DPIE Water and the EPA, to the satisfaction of the Planning Secretary. This SWMP (including all appendices) was provided to DPIE Water and EPA for review and comment 26 August 2020. The EPA provided correspondence dated 4 September 2020 advising that it is not the role of the EPA to review management plans. No comments were received from DPIE Water/NRAR. Version 2 of the SWMP was approved by DPIE 20 November 2020.

The SWMP was revised following minor comments received from DPE and DPE- Water around the Extraction Plan for LW24-26. A copy of the SWMP was provided to the EPA for comment 29 November 2023 and approved by DPE X.

Correspondence in relation to the SWMP is attached as **Appendix A**.

## 1.6 Statement of Commitments

A Summary of Commitments for this SWMP is included in **Appendix B**.

## 2.0 Statutory Requirements

This SWMP has been prepared to fulfil all statutory requirements relating to surface water management at the Wambo Coal Mine, including:

- Relevant legislation, policies, guidelines and standards;
- DA305-7-2003 and DA177-8-2004 Conditions of Consent (CoC);
- Environment Protection Licence (EPL 529) conditions;
- Recommendations from the 2017 Independent Environmental Audit (Hansen Bailey, 2018);
- Surface Water Access Licence conditions; and
- Requirements from regulators on additional monitoring requirements for the North Wambo Creek Diversion (NWCD).

There are no commitments in the *United Wambo Open Cut Project Environmental Impact Assessment* (Umwelt, 2016) relevant to this SWMP, however there are commitments relating to surface water management and monitoring for the United Wambo Open Cut project that are addressed as part of the shared **WMP** and **SWB**. Further information on these commitments and how they have been addressed is contained in the United Wambo Surface Water Management Plan.

### 2.1 Legislation, Policies, Guidelines and Standards

The legislation relevant to this SWMP is described in Section 2.1 of the **WMP**.

The policies, guidelines and standards relevant to this SWMP are described in Section 2.2 of the **WMP**.

### 2.2 DA305-7-2003 Conditions of Consent

WCPL received development consent (DA305-7-2003) in accordance with the *Environmental Planning & Assessment Act 1979* (EP&A Act) from DPIE, formerly NSW Department of Planning and Environment (DP&E), on 4 February 2004. The most recent modification to DA305-7-2003 was granted by the Independent Planning Commission of NSW on 29 August 2019 (Modification 16).

DA305-7-2003 requirements related to the development of this SWMP are summarised in **Table 1**. Surface water management performance measures relevant to this SWMP, as specified in Condition B62 of DA305-7-2003, are listed in **Table 2**.

**Table 1: DA305-7-2003 Requirements for this SWMP**

Condition	Condition Details	SWMP Section
B66	(iv) <u>Surface Water Management Plan</u> , that includes:	Entire document
	(iv) detailed baseline data of surface water flows and quality of watercourses and/or waterbodies potentially impacted by the development, including: <ul style="list-style-type: none"> <li>o stream and riparian vegetation health;</li> <li>o channel stability (geomorphology); and</li> <li>o water supply for other surface water users;</li> </ul>	Section 3.0
	(v) a detailed description of the surface water management system;	Section 5.1
	(vi) detailed plans, design objectives and performance criteria for water infrastructure including: <ul style="list-style-type: none"> <li>o any approved creek diversions or restoration works associated with the development;</li> <li>o water run-off diversions and catch drains;</li> <li>o water storages and sediment dams;</li> <li>o emplacement areas and tailings storages; and</li> <li>o reinstated drainage networks on rehabilitated areas of the site;</li> </ul>	Section 5.1.1 (see also Appendix D for NWCD MP)
	(vii) detailed performance criteria, including triggers for identifying and investigating any potentially adverse impacts associated with the development, on: <ul style="list-style-type: none"> <li>o downstream surface water flows and quality (including Wollombi Brook, North Wambo, South Wambo, and Stony Creeks);</li> <li>o channel stability;</li> <li>o stream and riparian vegetation health;</li> <li>o water supply for other water users; and</li> <li>o post-mining water pollution from rehabilitated areas of the site;</li> </ul>	Section 4.0
	<ul style="list-style-type: none"> <li>• a program to monitor:               <ul style="list-style-type: none"> <li>o compliance with the relevant performance measures listed in Table 8 and the performance criteria established above;</li> <li>o controlled and uncontrolled discharges and seepage/leachate from the site;</li> <li>o impacts on water supply for other water users;</li> <li>o surface water inflows, outflows and storage volumes to inform the Site Water Balance; and</li> <li>o the effectiveness of the surface water management system and the measures within the Erosion and Sediment Control Plan;</li> </ul> </li> </ul>	Section 6.0 (see also WMPProg)
	<ul style="list-style-type: none"> <li>• reporting procedures for the results of the monitoring program;</li> </ul>	Section 9.2
	<ul style="list-style-type: none"> <li>• a plan to respond to any exceedances of the surface water performance criteria, and repair, mitigate, compensate and/or offset any adverse surface water impacts of the development; and</li> </ul>	Section 7.0
D5	<b>Management Plan Requirements</b>	
	The Applicant must ensure that the management plans required under this consent are prepared in accordance with any relevant guidelines, and include where relevant:	Section 2.1
	(a) summary of relevant background or baseline data;	Section 3.0
	(b) details of: <ul style="list-style-type: none"> <li>• the relevant statutory requirements (including any relevant approval, licence or lease conditions);</li> </ul>	Section 2.0
	<ul style="list-style-type: none"> <li>• any relevant limits or performance measures and criteria;</li> </ul>	Table 2, Table 3 and Section 4.0
<ul style="list-style-type: none"> <li>• the specific performance indicators that are proposed to be used to judge</li> </ul>	Section 4.0	

Condition	Condition Details	SWMP Section
	the performance of, or guide the implementation of, the development or any management measures;	
	(c) any relevant commitments or recommendations identified in the document/s listed in condition A2(c);	<b>Section 2.0</b>
	(d) a description of the measures to be implemented to comply with the relevant statutory requirements, limits, or performance measures and criteria;	<b>Sections 5.0 and 6.0</b>
	(e) a program to monitor and report on the: <ul style="list-style-type: none"> <li>• impacts and environmental performance of the development; and</li> <li>• effectiveness of any management measures set out pursuant to paragraph (d);</li> </ul>	<b>Monitoring – Section 6.0 Reporting - Section 9.0</b>
	(f) a contingency plan to manage any unpredicted impacts and their consequences and to ensure that ongoing impacts reduce to levels below relevant impact assessment criteria as quickly as possible;	<b>Section 7.0</b>
	(g) a program to investigate and implement ways to improve the environmental performance of the development over time;	<b>Section 9.2.1</b>
	(h) a protocol for managing and reporting any: <ul style="list-style-type: none"> <li>• incident, non-compliance or exceedance of any impact assessment criterion and performance criterion;</li> </ul>	<b>Managing – Section 7.0 Reporting – Section 9.2.4</b>
	<ul style="list-style-type: none"> <li>• complaint; or</li> </ul>	<b>Section 8.0</b>
	<ul style="list-style-type: none"> <li>• failure to comply with other statutory requirements; and</li> </ul>	<b>Section 7.4</b>
	(i) a protocol for periodic review of the plan.	<b>Section 9.1</b>

**Table 2: DA305-7-2003 Surface Water Management Performance Measures**

Feature	Performance Measure <sup>1,2</sup>	SWMP Section
Water management – general	<ul style="list-style-type: none"> <li>Maintain separation between clean, dirty and mine water</li> <li>Minimise the use of clean and potable water</li> <li>Maximise water recycling, reuse and sharing opportunities</li> <li>Minimise the use of make-up water from external sources</li> <li>Design, install, operate and maintain water management infrastructure in a proper and efficient manner</li> </ul>	<b>Section 5.1 (See also WMP, GWMP &amp; ESCP)</b>
Clean water diversions and storage infrastructure	<ul style="list-style-type: none"> <li>Design, install and maintain the clean water system to capture and convey the 100 year ARI flood event</li> <li>Maximise, as far as reasonable, the diversion of clean water around disturbed areas on the site, except where clean water is captured for use on the site</li> </ul>	<b>Section 5.1 (see also ESCP)</b>
Above-ground mine water storages	<ul style="list-style-type: none"> <li>Design, install and maintain mine water storage infrastructure to avoid unlicensed or uncontrolled discharge of mine water</li> </ul>	<b>Section 5.1.1</b>
Prescribed dams under the Dams Safety Act 1978 or Dams Safety Act 2015 (including South Wambo Dam)	<ul style="list-style-type: none"> <li>Design, constructed and operated to the satisfaction of NSW Dams Safety Committee (DSC)</li> <li>Drained prior to the commencement of secondary workings in underlying longwalls, to the satisfaction of DSC 2000) and <i>Using the ANZECC Guidelines and Water Quality Objectives in NSW</i> (DEC, 2006)</li> </ul>	<b>Section 5.3</b>

Notes to **Table 2**:

- The performance measures in **Table 2** do not apply to water management structures constructed prior to the approval of Modification 16 (to DA305-7-2003).
- Performance measures relating to erosion and sediment controls are addressed in the **ESCP**.

Other DA305-7-2003 conditions relating to general water management are addressed in the **WMP**.

## 2.3 DA177-8-2004 Conditions of Consent

WCPL received Development Consent (DA177-8-2004) in accordance with the EP&A Act from the NSW DPIE on 16 December 2004. The most recent modification to DA177-8-2004 was granted by the Independent Planning Commission of NSW on 29 August 2019 (Mod 3).

Surface water management performance measures, as specified in Condition B9 of DA177-8-2004, are listed in **Table 3**.

**Table 3: DA177-8-2004 Surface Water Management Performance Measures**

Feature	Performance Measure <sup>1, 2</sup>	SWMP Section
Water management – general	<ul style="list-style-type: none"> <li>Maintain separation between clean, dirty and mine water</li> <li>Minimise the use of clean and potable water</li> <li>Maximise water recycling, reuse and sharing opportunities</li> <li>Minimise the use of make-up water from external sources</li> <li>Design, install, operate and maintain water management infrastructure in a proper and efficient manner</li> </ul>	<b>Section 5.1 (See also WMP, GWMP &amp; ESCP)</b>
Chemical and hydrocarbon storage	<ul style="list-style-type: none"> <li>Chemical and hydrocarbon products to be stored in bunded areas in accordance with the relevant Australian Standard</li> </ul>	<b>Sections 5.5 and 5.8.1</b>
Above-ground storage tanks containing materials likely to cause environmental harm	<ul style="list-style-type: none"> <li>Imperviously bunded with a capacity of 110% that of the largest container stored within the bund</li> <li>Designed and constructed in a manner which prevents the ingress of rain water into the tanks</li> <li>Clearly labelled to identify contents</li> </ul>	<b>Sections 5.5 and 5.8.1</b>

Notes to **Table 3**:

- The performance measures in **Table 3** do not apply to water management structures constructed prior to the approval of Modification 3 (to DA177-8-2004).
- Performance measures relating to erosion and sediment controls are addressed in the **ESCP**.

Other DA177-8-2004 conditions relating to general water management are addressed in the **WMP**.

## 2.4 EPL 529 Conditions

The EPA issued EPL 529 on 27 September 2000 under the *Protection of the Environment Operations Act 1997* (POEO Act). The EPL permits activities that may impact on surface and ground water to occur across the site, subject to the EPL conditions (**Appendix C**). With the exception of these conditions, WCPL must comply with section 120 of the POEO Act.

In consultation with the EPA, the EPL will be modified (as required) to reflect any relevant modified development consent conditions.

Under EPL 529 and the Hunter River Salinity Trading Scheme (HRSTS), WCPL is required to monitor discharges from a designated licenced discharge point. **Section 4.1** provides further information on discharge requirements under the HRSTS.

## 2.5 Independent Environmental Audit Recommendations

In 2017 Hansen Bailey conducted an Independent Environmental Audit of the Mine, in accordance with the requirements of Condition D11 of DA305-7-2003 and DA177-8-2004 (Hansen Bailey, 2018). Recommendations from the audit report relating to this SWMP, and where they are addressed, are contained in **Table 4**.

**Table 4: 2017 IEA Recommendations relevant to this SWMP**

Recommendation	SWMP Section
It is recommended that WCPL also collect water quality data from sediment dams in order to characterise the quality of runoff from non-coal affected catchments.	<b>Section 6.1.4</b>
Consideration should be made to directly monitor the quality of groundwater seepage reporting to the underground and open-cut workings.	<b>Section 6.1.10</b>
It is suggested that the salt balance be updated annually to include the seepage quality monitoring data.	<b>Sections 6.1.10 and 5.7</b>
WCPL should determine the frequency of monitoring to apply for the salt balance model.	<b>Section 6.1.10</b>
Section 2.2.16 of the Site Water Management Plan outlines rehabilitation objectives for decommissioning water management structures on site. It is recommended that this section is improved by providing a high level strategy for the decommissioning of water management structures (including the management of water during the decommissioning process) as part of any future update of the Site Water Management Plan.	<b>Section 5.9</b>
It is recommended that the Site Water Management Plan is updated to include the predicted salt balance.	<b>Section 3.5</b>

There were no recommendations relating to surface water in the 2020 Independent Environmental Audit conducted by GHD.

## 2.6 Surface Water Licence Conditions

Both United and Wambo hold Water Access Licences (WALs) under the Water Sharing Plan for the Hunter Regulated River (2004) and the Water Sharing Plan for the Hunter Unregulated and Alluvial Water Sources (2009) for extraction of water from the Wollombi Brook and Hunter River. **Table 5** presents the WALs held by United and Wambo.

Groundwater entitlements are outlined in the **GWMP**.



**Table 5: Surface Water Licences for United and Wambo**

Licence No	Water Source	Category	Holder	Share Component	Tenure Type
WAL718	Hunter Regulated River Water Source	Regulated River (High Security)	Wambo	1000 units	Continuing
WAL8599	Hunter Regulated River Water Source	Regulated River (High Security)	Wambo	6 units	Continuing
WAL8600	Hunter Regulated River Water Source	Regulated River (General Security)	Wambo	868 units	Continuing
WAL8604	Hunter Regulated River Water Source	Supplementary Water	Wambo	240 units	Continuing
WAL43299	Hunter Regulated River Water Source	Regulated River (General Security)	Wambo	80 units	Continuing
WAL10541	Hunter Regulated River Water Source	Regulated River (High Security)	United	300 units	Continuing
WAL929	Hunter Regulated River Water Source	Domestic and Stock	United and Wambo	3 units	Continuing
WAL1369	Hunter Regulated River Water Source	Regulated River (Supplementary)	Wambo and United	15 units	Continuing
WAL15459	Hunter Regulated River Water Source	Regulated River General Security)	Wambo and United	21 units	Continuing
WAL1164	Hunter Regulated River Water Source	Regulated River General Security)	Wambo and United	180 units	tbc
WAL902	Hunter Regulated River Water Source	-	Wambo and United	8 units	tbc
WAL18445	Hunter Unregulated and Alluvial Water Sources (Lower Wollombi Brook Water Source)	Unregulated River	United	200 units	Continuing
WAL18549	Hunter Unregulated and Alluvial Water Sources (Lower Wollombi Brook Water Source)	Unregulated River	United	100 units	Continuing
WAL18437	Hunter Unregulated and Alluvial Water Sources (Lower Wollombi Brook Water Source)	Unregulated River	Wambo	366.9 units	Continuing
WAL 23897	Hunter Unregulated and Alluvial Water Sources (Lower Wollombi Brook Water Source)	Aquifer	Wambo	70 units	Continuing

WCPL will report performance against relevant surface water licence conditions in the Annual Review (refer **Section 9.2.1**).

## 2.7 Additional Regulator Requirements

In April 2008, the North Wambo Creek Diversion Plan was approved subject to the additional requirements shown in **Table 6**. These requirements have been addressed in this SWMP.

**Table 6: Additional Surface Water Monitoring Program Requirements**

Regulator	Requirement	SWMP Section
DPIE	<p>1. The SWMP must be updated to include at least two additional surface monitoring sites within the area of the North Wambo Creek Diversion footprint to replace those to be discontinued in the old North Wambo Creek footprint i.e. SW27 &amp; SW32 have been replaced by SW41, SW47 and SW48.</p> <p>2. The company must comply with the requirements of the Department of Water and Energy (DWE) and the Department of Primary Industries (DPI) as outlined in the attached letters to the company ....</p>	<p><b>Section 6.0 and WMProg</b></p> <p><b>See below</b></p>
DPI-Water (formerly NSW Office of Water (NOW)/ Department of Water and Energy (DWE))	<p>DWE grants approval to the detailed design plans for the constructed diversion channel, subject to the following;</p> <p>Monitoring of discharge flows, and calculation of bankfull discharge capacities and velocities along the channel shall occur at the first discharge event along the diversion channel, and then thereafter as directed by the DWE;</p> <p>Comparative performance with agreed reaches upstream and downstream of the diversion shall occur, together with agreed stable reaches of control catchments, as approved by DWE;</p> <p>Reporting on performance of the diversion channel shall occur annually (in AEMR).</p>	<p><b>Section 6.1.7</b></p> <p><b>Section 6.1.7</b></p> <p><b>Section 9.2.1</b></p>

## 3.0 Existing Environment and Baseline Data

### 3.1 Existing Environment

The existing environment is described in detail in the EIS (Umwelt 2016) and summarised (with respect to water) in Section 3.1 of the **WMP**. This includes information on:

- Rainfall;
- Geological setting; and
- Topography and vegetation.

#### 3.1.1 Surface Water Context

The mine site is within the lower Wollombi Brook catchment near its confluence with the Hunter River. Wollombi Brook drains an area of approximately 1,950 km<sup>2</sup> (Gilbert and Associates, 2003) and joins the Hunter River some 5 km north- east of Wambo (**Figure 3**).

Surface runoff from the majority of land within the WCPL's project area drains to Wollombi Brook via a series of generally easterly flowing creeks including South and North Wambo Creek, Stony Creek, Waterfall Creek and Redbank Creek. South Wambo Creek and its main tributary Stony Creek rise in the Wollemi National Park escarpment south of the mine and drain the southern and south-western parts of the mining lease area. Waterfall Creek drains the north end of the mining lease area. Relatively smaller parts of the northern side of the site drain to Redbank Creek in the United Collieries lease area (**Figure 4**).

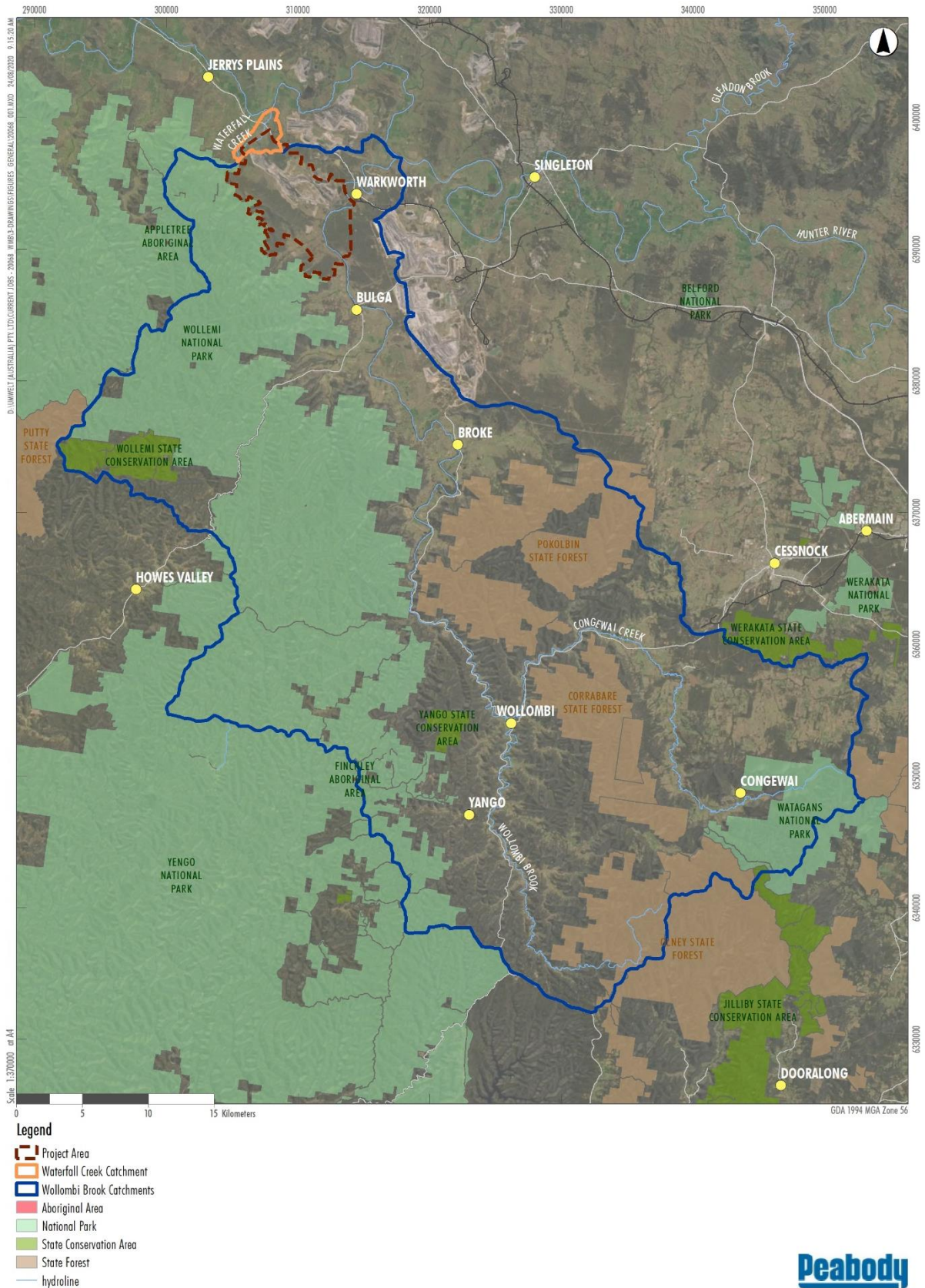
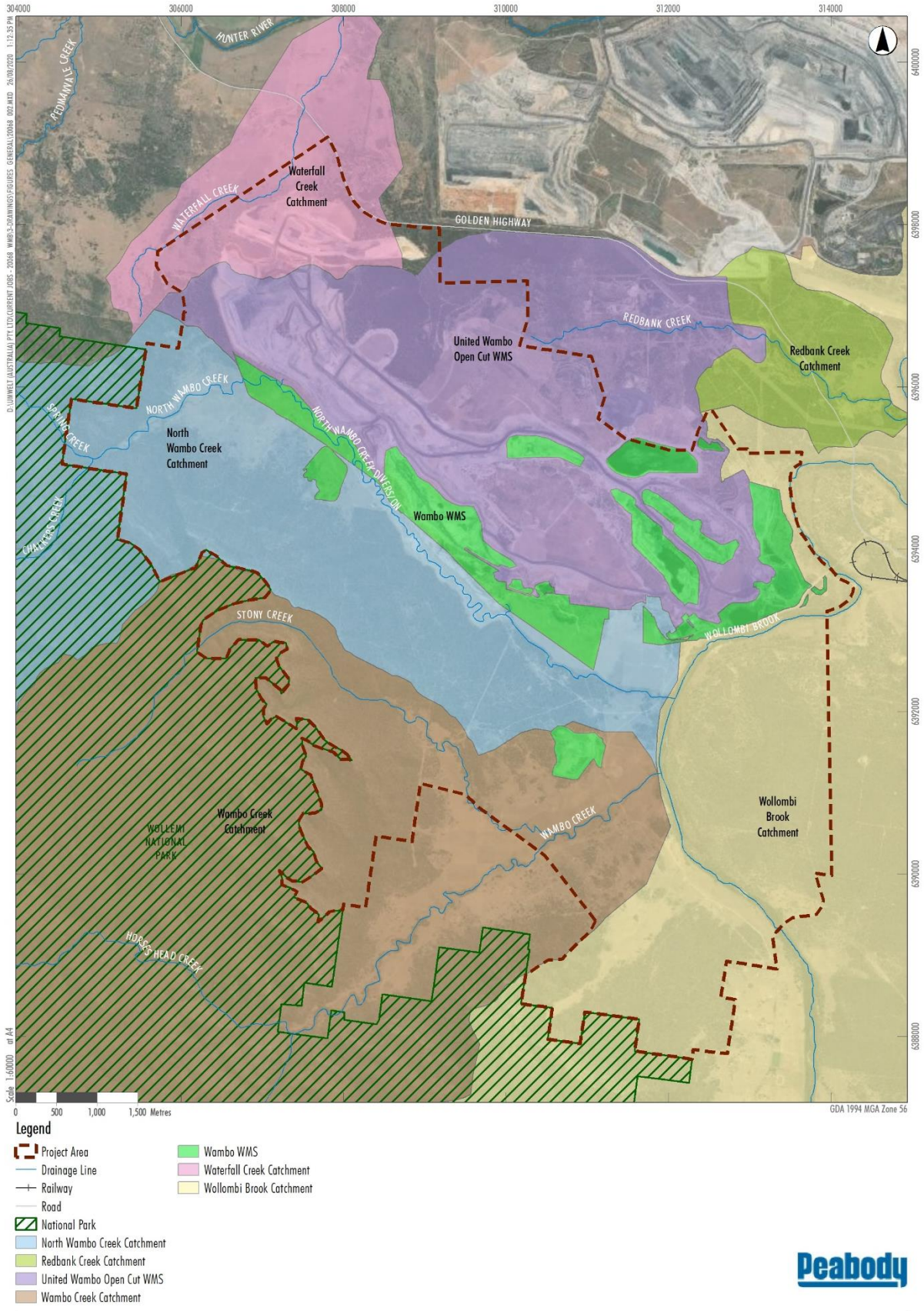

Image Source: ESRI Basemap Data source: DFSI (2020)

**Figure 3: Wollombi Brook Catchment Context**



**Figure 4: Project Area Catchment Context**

North Wambo Creek, which also has its headwaters in the Wollemi escarpment, drains the central parts of the mining lease. A section of North Wambo Creek has been diverted to avoid the Wambo open cut (**Figure 4**). The North Wambo Creek Diversion was constructed in accordance with the approved North Wambo Creek Diversion Plan (WCPL, 2007b).

The rail line also crosses numerous small ephemeral creek systems including Longford Creek and Doctors Creek, which discharge into the Hunter River.

**Table 7** provides the catchment areas of the creeks within WCPL’s Mining Lease Boundaries and in the vicinity of the WCPL rail line and Wambo rail loop.

**Table 7: Catchment Areas of Local Creeks\***

Creek	Catchment Area (km <sup>2</sup> )
North Wambo Creek	48.5
South Wambo Creek	43.2
Stony Creek	11.2
Redbank Creek	12.3
Waterfall Creek	5.5
Longford Creek	0.89 <sup>1</sup>
Doctors Creek	1.58 <sup>1</sup>

\* Source: Gilbert and Associates (2003) and Mackie Environmental Research (MER) (2002).

Note to **Table 7**:

1. Mining operations from the Warkworth Mine will reduce the catchment size of these systems. The figure provided is the estimated catchment size.

### 3.2 Water Supply for Surface Water Users

Surface and alluvial water take within the unregulated watercourses surrounding the Project Area (i.e. Wollombi Brook catchment and Waterfall Creek catchment) is regulated under the Water Management Act 2000 (WM Act). Water take from the Hunter River is also regulated under the WM Act.

Water is extracted from both Wollombi Brook and the Hunter River by United and Wambo. Extraction of water from the Hunter River is managed under the Water Sharing Plan (WSP) for the Hunter Regulated River Water Source (2004).

There are no known licensed non-mining water users on waterways directly downstream of the Project Area along Wollombi Brook, its tributaries (Wambo Creek, North Wambo Creek and Redbank Creek) or Waterfall Creek. There are licensed water users downstream of the Project Area on the Hunter River which is a regulated river with extraction managed by WaterNSW and the Natural Resource Access Regulator (NRAR). Water is also extracted downstream of the Project Area from the Hunter River for stock and domestic purposes. All extractions from the downstream watercourses are managed under the *Water Management Act 2000*, the Water Management (General) Regulation and relevant WSPs.

### 3.3 Surface Water Monitoring Network

Surface water monitoring data has been collected at Wambo since 2003. Monitoring locations have been established along a number of watercourses to monitor both water quality and flow. The sites are comprised Wambo only, combined Wambo and United Wambo monitoring sites and Wambo United Open Cut sites. Monitoring locations are summarised in **Table 8**. Monitoring of mine water storages has also been undertaken for management purposes. Monitoring locations are shown on **Figure 5**. The surface water monitoring program is also summarised in the *WMPProg*.

**Table 8: Surface Water Monitoring Locations**

Site ID	Easting	Northing	Site Description
<b>Wambo and United Wambo Combined Monitoring sites - Surface Water Quality</b>			
SW40	311910	6391093	Wollombi Brook - Upstream
SW03	312509	6392866	Wollombi Brook - Pumps
SW02	314376	6395037	Wollombi Brook - Warkworth
SW04	306887	6396024	North Wambo Creek - Upstream
SW32a	309905	6393191	North Wambo Creek - Midstream
SW05	311927	6392157	North Wambo Creek - Downstream
SW39	307194	6398519	Waterfall Creek (Downstream)
SW54	305900	6397890	Waterfall Creek (Upstream)
SW52	312677	6395220	C11 Void
SW31	313276	6393987	CHPP Dams
SW14	312179	6392939	Wambo MIA Box Cut Dam
SW38	311750	6394190	Homestead Pit
<b>Wambo only Monitoring sites - Surface Water Quality</b>			
SW01	314429	6385707	Wollombi Brook, upstream of Wambo Coal Operations
SW06	309056	6389550	South Wambo Creek upstream of Wambo Coal former operations
SW07	311263	6390718	South Wambo Creek downstream of Wambo Coal former operations and junction with Stony Creek
SW08	308536	6392133	Stony Creek
SW08a <sup>1</sup>	307845	6392470	Stony Creek Upstream (275m upstream of NWU LW1)
SW08b <sup>1</sup>	308247.2	6392138	Stony Creek Downstream (250m downstream of washed out crossing, overlying NWU LW1 adjacent to P319 standpipe)
SW15	313133	6393073	Eagles Nest (Process Water Dam) (EPA ID No. 4)
SW27a	309431	6393558	North Wambo Creek (middle of diversion)
SW41	307257	6398952	Waterfall Creek Downstream
USFM1	305250	6395200	Upper reaches of North Wambo Creek
SW53 <sup>2</sup>	311904	6391464.	South Wambo Dam – (EPL 529, ID No.19)
STP001	312057	6393219	Monitoring of water quality from the sewage treatment plant discharge (EPL 529, ID No. 18)
<b>Stream Flow and Volume</b>			
USFM1	305250	6398952	Upper reaches of North Wambo Creek
FM1A	307013	6396135	North Wambo Creek – confluence (relocated December 2017)
FM2	308181	6395028	North Wambo Creek – middle of diversion
FM3	309114	6393813	North Wambo Creek – Middle-Lower
FM4	311890	6392288	North Wambo Creek - downstream near confluence of Wollombi Brook
FM9	308666	6389176	South Wambo Creek - upstream of confluence of Stony Creek (relocated September 2018)
FM10 <sup>3</sup>	314228	6395064	Wollombi Brook - downstream from Wambo Coal at Warkworth
FM11 <sup>3</sup>	314360	6385900	Wollombi Brook - upstream from Wambo Coal at the Bulga Village
FM12	307607	6392828	Stony Creek Upstream (installed December 2015, relocated September 2018 approximately 50m downstream of original location)
FM13	309530	6391043	Stony Creek Downstream (installed December 2015, relocated September 2018 approximately 50m downstream of original location)
FM14	307730	6392246	Stony Creek Tributary (installed December 2015)
FM15	311680	6391089	South Wambo Creek (installed December 2016)
FM16	311259	6390666	South Wambo Creek (installed December 2016)
US FM1	305261	6395212	North Wambo Creek – upstream (installed December 2017)
SW15	313133	6393073	Eagles Nest Process Water Dam (EPA ID No. 4)
SW53 <sup>2</sup>	311904	6391464.	South Wambo Dam – (EPL 529, ID No.19)

Notes to **Table 8:**

1. SW08a and SW08b established September 2022 (NWU LW1 = North Wambo Underground Longwall panel 1)
2. Subject to recommissioning of South Wambo Dam
3. Data sourced from DPIE Water Gauging Stations on Wollombi Brook at Bulga [GS21004] and Warkworth [GS210028]

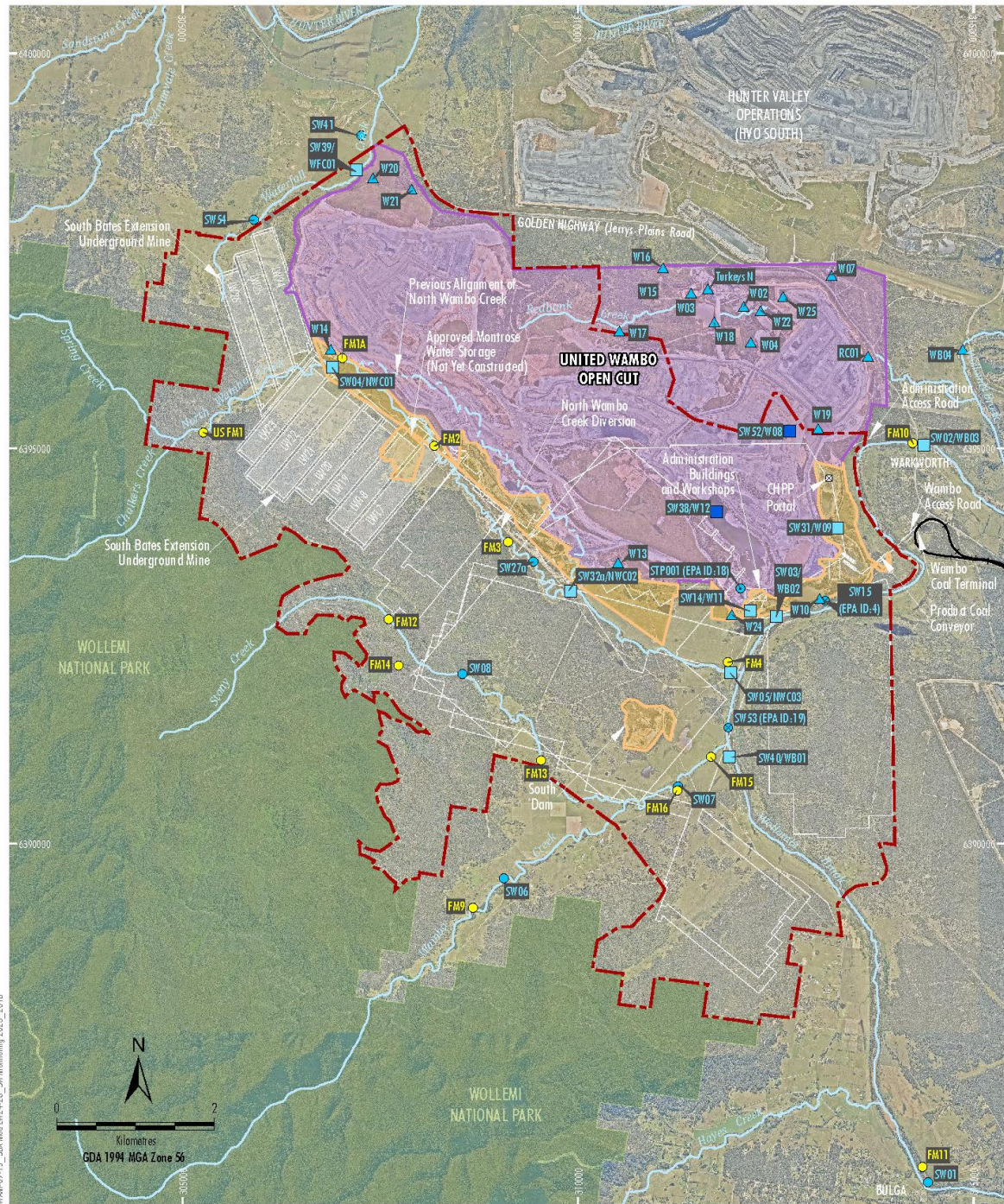

Source: WCPL (2023); NSW Spatial Services (2023)  
Orthophoto Mosaic: WCPL (May, Nov 2022)

- LEGEND**
- National Park
  - Warbo DA 305-7-2003
  - SSD 7142 Operational Area \*
  - Existing/Approved Wambo Coal Mine Surface Development Area
  - Existing/Approved Underground Development
- MONITORING LOCATIONS**
- Wambo Only Monitoring Sites**
- Flow Monitoring
  - Water Quality
  - Water Quality - LDP
  - Water Quality and Discharge Volume - LDP
- LW OC Only Monitoring Sites**
- LW OC Water Quality
  - Shared Monitoring Sites
  - Wambo Water Quality
  - LW OC Water Quality
- \* Under Phase 2 of mining at Wambo Coal Mine (commenced 1 December 2020), this area is operated by United Collieries Pty Ltd under the United Wambo Joint Venture Project.

**Peabody**  
W A M B O C O A L M I N E  
Surface Water Monitoring Locations

**Figure 5: Wambo Surface Water Monitoring Locations**



### 3.3.1 Historical Flow Monitoring Locations

From January 2004 until June 2007 WCPL monitored stream flow at four locations on South Wambo Creek (sites V1 and V2) and Stony Creeks (sites V7 and V8). Automatic data loggers recorded flow at hourly intervals. No flows were observed at sites V1, V2 and V7 between January 2004 and June 2007. The single flow record for site V8 is provided in **Section 3.4.2 (Table 11)**.

Flow monitoring at Weir 3 has generally shown North Wambo Creek to be dry, except following significant rainfall. The highest flow recorded at Weir 3 was 0.1 L/sec in late May 2002 (Geoterra, 2005).

## 3.4 Review of Baseline Data

### 3.4.1 Surface Water Quality

A summary of surface water quality monitoring results for July 2003 to December 2019 is presented in **Table 9**.

**Table 9: Surface Water Quality Ranges – Local Watercourses**

Sites	Sampling Period	pH			EC (uS/cm)			TDS (mg/L)			TSS (mg/L)		
		Min	Max	Mean	Min	Max	Mean	Min	Max	Mean	Min	Max	Mean
SW01 - Wollombi Brook Up	Jul 03 – Jul 20	6.5	8.8	7.6	160	1969	747	60	1157	406	1	128	10
SW02 - Wollombi Brook Down	Jul 03 – Jul 20	6.3	9.0	7.6	148	5,290	1179	25	3,238	684	1	308	15
SW03 - Wollombi Brook Pump Out	Jul 03 – Jul 20	6.3	9.1	7.6	106	6280	1319	3	2,924	681	1	1,630	43
SW04 - North Wambo Creek Up	Jul 03 – Jul 20	6.8	8.7	7.7	256	563	351	157	2,712	855	5	154	41
SW05 - North Wambo Creek Down	Jul 03 – Jul 20	6.6	9.5	7.7	111	4,770	1,828	135	2,162	996	1	1110	41
SW06 - South Wambo Creek	Jul 03 – Jul 20	6.3	9.1	7.3	119	970	500	28	440	264	1	286	20
SW07 - South Wambo/Stony Creeks	Jul 03 – Jul 20	6.4	9.1	7.5	159	1118	594	145	720	334	1	331	25
SW08 - Stony Creek	Jul 03 – Jul 20	6.2	8.4	7.1	186	479	344	58	276	186	1	61	6
SW15 – Eagles Nest Dam	Jan 18 – Dec 19	7.6	9.3	8.9	2,750	9,210	6,768	ND	ND	ND	20	5,800	336
SW27a - North Wambo Creek Middle Lower	Jul 03 – Jul 20	7.0	9.0	7.9	52	3,360	890	48	4,900	957	1	5440	472
SW32a - North Wambo Creek Pump	Jul 03 – Jul 20	7.2	9.20	8.0	199	6,970	794	153	4,400	779	1	4,190	451
SW39 - Waterfall Creek	Jul 03 – Jul 20	6.6	9.3	7.6	92	1,268	337	82	2,220	514	8	2,600	391
SW40 - Wollombi Brook Upstream of South Wambo Creek	Jul 03 – Jul 20	6.4	8.8	7.6	36	2940	718	18	1090	354	1	179	17
USFM1 - North Wambo Creek upstream Flow Station 1	Jun 19 – Jul 20	ND	ND	ND	ND	ND	ND	ND	ND	ND	ND	ND	ND

Notes to **Table 9**

\* ND – no data available

### 3.4.2 Stream Flow

WCPL operate eleven continuous flow gauging stations, which are located along North Wambo Creek (five stations), Stony Creek (two stations) and South Wambo Creek (three stations plus another station located on a major tributary). The ephemeral nature of these creeks has resulted in extended no-flow periods. These gauging stations replaced the previous V-notch weir flow measurement points, which were destroyed during the June 2007 flood event.

Additionally, surface water flow monitoring data for Wollombi Brook is sourced from DPIE Water operated flow gauging stations, located at Warkworth (FM10) and Bulga (FM11). A summary of the stream flow data is provided in **Table 10**.

**Table 10: Stream Flow Monitoring Data Summary**

Site	Location	Period of Record	Flow Days*	Max (M/L Day)	Mean per Flow Day (ML/Day)	% Results with no Data Available
US FM1	North Wambo Creek (Upper)	Dec 2017 – 31/01/2018	No flow events were recorded since installation in December 2017			
		1/02/2018 to 31/12/2019	0	NA	NA	NA
FM1A (old FM1)	North Wambo Creek	21/10/2008 to 1/12/2009	31	264.81	0.77	NA
		2/12/2009 to 30/06/2012	No flow data available			
		1/07/2012 to 30/06/2013	NA	1.296	0.086	16.7%
		1/07/2013 to 31/01/2014	NA	NA	NA	85.7%
		1/02/2014 to 19/08/2014	No flow data available			
		1/02/2015 to 31/01/2016	38	210	21.8	Negligible
		1/02/2016 to 31/01/2017	0	0	0	Negligible
		1/02/2017 to 31/01/2018	0	NA	NA	NA
		1/02/2018 to 31/12/2019	0	NA	NA	NA
		FM2	Mid way along the old North Wambo Creek Diversion	12/04/2009 to 1/12/2009	6.5	0.05
2/12/2009 to 30/06/2012	No flow data available					
1/07/2012 to 30/06/2013	9			0.39	<0.09	66.7%
1/07/2013 to 31/01/2014	NA			18.1	0.69	0.0%
1/02/2014 to 19/08/2014	42			22.59	1.57	Negligible
1/02/2015 to 31/01/2016	128			160	7.3	Negligible
1/02/2016 to 31/01/2017	82			12	1.4	Negligible
1/02/2017 to 31/01/2018	6			20.6	1.53	Negligible
1/02/2018 to 31/01/2019	8			2.46	1.12	NA
1/02/2019 to 31/12/2019	3			11.3	4.76	NA
FM3	Midway along the new	1/02/2015 to 31/01/2016	29	140	5.2	Negligible

Site	Location	Period of Record	Flow Days*	Max (M/L Day)	Mean per Flow Day (ML/Day)	% Results with no Data Available
	diversion of North Wambo Creek	1/02/2016 to 31/01/2017	5	3.7	0.3	Negligible
		1/02/2017 to 31/01/2018	6	52.3	2.6	Negligible
		1/02/2018 to 31/01/2019	11	6.77	2.75	NA
		1/02/2019 to 31/12/2019	5	8.07	3.09	NA
FM4	North Wambo Creek (Upstream of the confluence of North Wambo Creek and Wollombi Brook)	21/10/2008 to 1/12/2009	391	237.14	1.36	NA
		2/12/2009 to 30/06/2012	No flow data available			
		1/07/2012 to 30/06/2013	21	200.8	86.8	58.3%
		1/07/2013 to 31/01/2014	0	0	0	14.3%
		1/02/2014 to 19/08/2014	6	291.28	59.07	Negligible
		1/02/2015 to 31/01/2016	16	14,300 <sup>#</sup>	1,817.2 <sup>#</sup>	Negligible
		1/02/2016 to 31/01/2017	0	0	0	Negligible
		1/02/2017 to 31/01/2018	2	56	18.65	Negligible
		1/02/2018 to 31/12/2019	0	NA	NA	NA
Brossi (old FM9)	South Wambo Creek (upstream of confluence of Stony Creek)	Sept 2018 – 31/12/2019	0	NA	NA	NA
FM12	Stony Creek upstream	1/02/2015 to 31/01/2016	40	210	7.0	Negligible
		1/02/2016 to 31/01/2017	31	0.39	0.09	Negligible
		1/02/2017 to 31/01/2018	15.7	2.75	0.59	Negligible
		1/02/2018 to 31/12/2019	0	NA	NA	NA
FM13	Stony Creek downstream	1/02/2015 to 31/01/2016	26	180	28	Negligible
		1/02/2016 to 31/01/2017	46	26	4.4	Negligible
		1/02/2017 to 31/01/2018	0	NA	NA	NA
		1/02/2018 to 31/12/2019	0	NA	NA	NA
FM14	Major tributary to Stony Creek	1/02/2015 to 31/01/2016	33	33	1.5	Negligible
		1/02/2016 to 31/01/2017	10	0.38	0.03	Negligible
		1/02/2017 to 31/01/2018	0	NA	NA	NA
		1/02/2018 to 31/01/2019	8	145	33.44	NA
		1/02/2019 to 31/12/2019	2	146	128	NA
	South Wambo Creek	1/02/2017 to 31/01/2018	0	NA	NA	NA

Site	Location	Period of Record	Flow Days*	Max (M/L Day)	Mean per Flow Day (ML/Day)	% Results with no Data Available
FM15 (old FM5)		1/02/2018 to 31/12/2019	0	NA	NA	NA
FM16 (old FM6)	South Wambo Creek	1/02/2017 to 31/01/2018	0	NA	NA	NA
		1/02/2018 to 31/12/2019	0	NA	NA	NA

Notes to **Table 10**:

NA – Parameter not available in data summary records.

No flow data available – Flow data not available due to damage to station or unreliable sensor responses.

# - A flow event at FM4 in April 2015 was influenced by backwater flooding from Wollombi Brook.

The flow monitoring data at FM10 and FM11 (DPIE Water operated stations), shows that Wollombi Brook is perennial and has a persistent baseflow which maintains flows between rainfall events. In comparison site drainages are ephemeral and typically only flow in response to intense rainfall events. Flow monitoring data has been used to characterise the flow regime of the monitored watercourses.

**Figure 6** shows the flow duration curves for Wollombi Brook at the DPIE Water gauging stations at Warkworth and Bulga (GS 210004 and GS 210028) which have been derived from flow recorded between 2003 and 2014. It is apparent that the distribution of flows in Wollombi Brook upstream and downstream of Wambo has generally been similar but with an increased frequency of low flows at the downstream station.

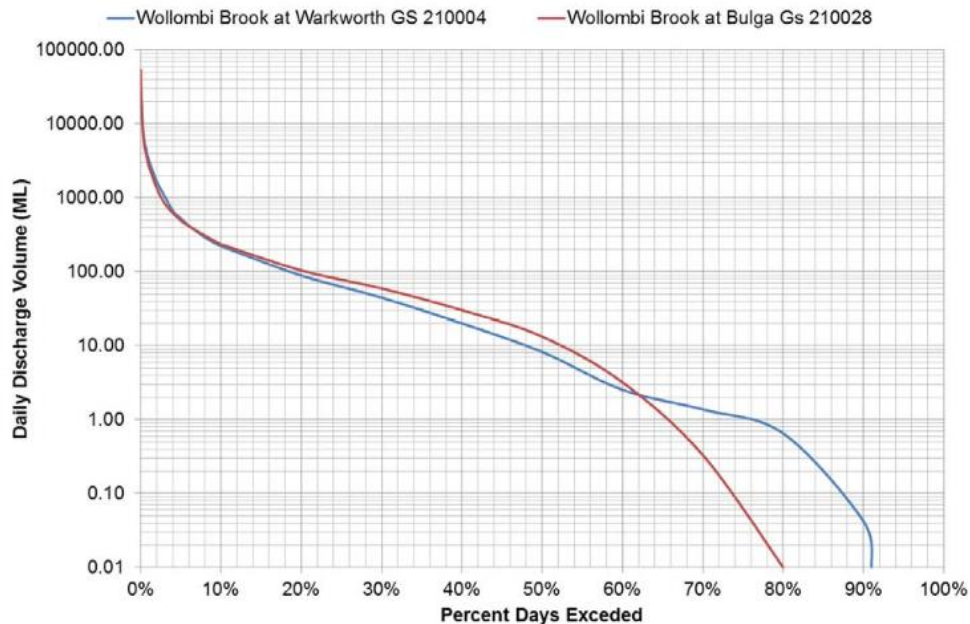

**Figure 6: Flow Duration Curves Wollombi Brook Upstream and Downstream of the Mine**

The available flow monitoring data for *North Wambo Creek* show that these creeks are all ephemeral and typically only flow in response to intense rainfall. This can be seen in **Figure 7** and **Figure 8**, which show monitored (non-zero) daily flow data and concurrent daily rainfall measured at the Wambo climate station.

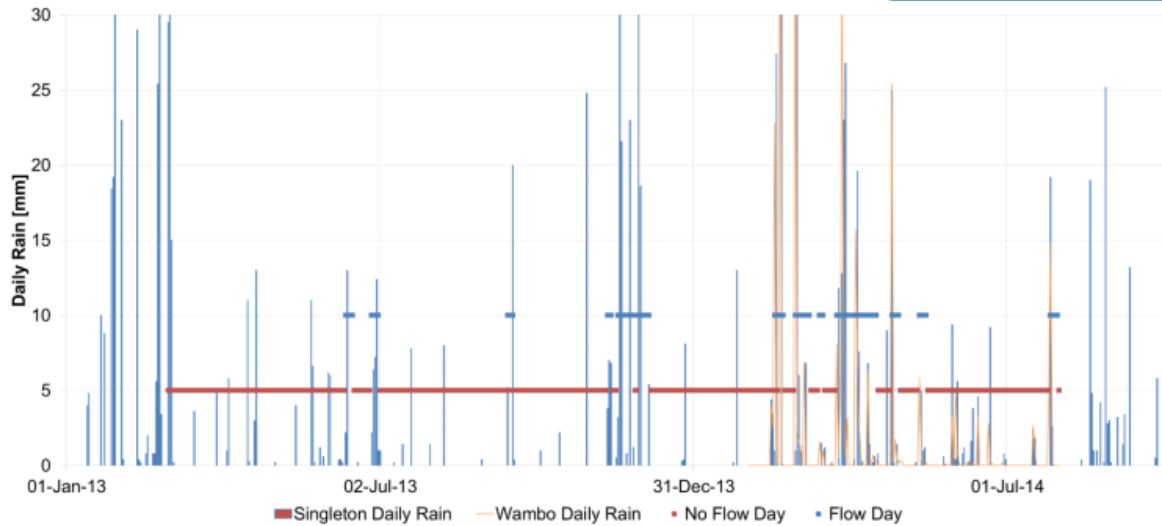

Figure 7: Recorded Daily Rainfall and Flow/No Flow Days – North Wambo Creek at FM2

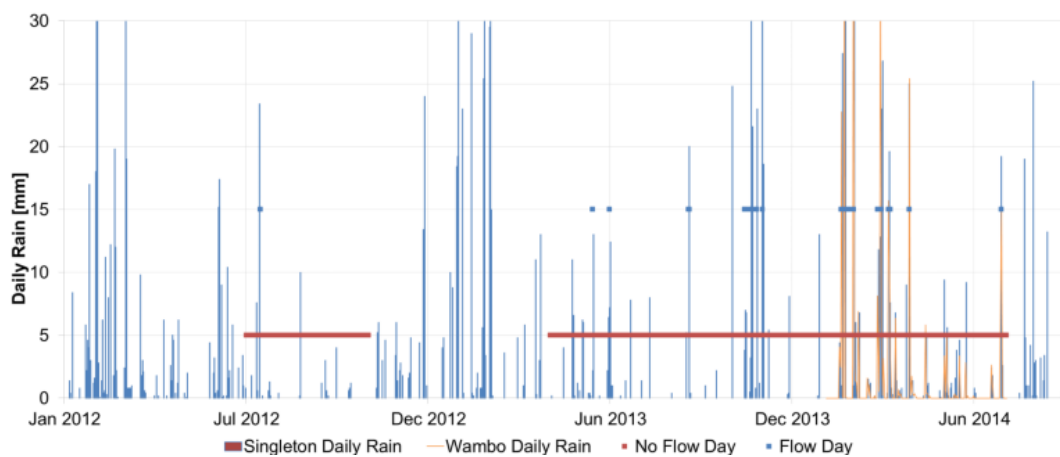

Figure 8: Recorded Daily Rainfall and Flow/No Flow Days – North Wambo Creek at FM4

Historical data for monitoring Site V8 and the two United sites (Weir 1 and Weir 2) is provided in **Table 11**.

Table 11: Stream Flow Summary for Historical Monitoring Sites

Site	Period of Record	Flow Days	Max (L/s Day)	Minimum (L/s)	Mean (L/s)
V8 – Stoney Creek	29 Jun 2005 - 10 Aug 2005	43	216.1	0.0	17.7
Weir 1 – North Wambo Creek	14 Jun 2002 – 1 Oct 2003	NA	9.3	0.0	1.5
Weir 2 - North Wambo Creek	14 Jun 2002 – 1 Oct 2003	NA	120.0	0.0	0.9

### 3.4.3 Riparian Vegetation Health and Channel Stability

A baseline Riparian Vegetation and Bed Bank Stability Monitoring Program commenced in October 2006 to monitor for potential subsidence impacts on the Wambo Creek and North Wambo Creek. A program to monitor riparian vegetation corridors along North Wambo, South Wambo and Stony Creeks has also been implemented. Details of both programs are presented in the Wambo **Biodiversity Management Plan (BMP)** and **NWCD MP** (for North Wambo Creek only) (refer **Appendix D**).

### 3.4.4 Geomorphic Assessment of North Wambo Creek

In 2017 WCPL commissioned Alluvium Consulting Australia to undertake a pre-subsidence (baseline) survey, energy profile analysis and geomorphic context statement on North Wambo Creek (the North Wambo Creek Baseline Report) (Alluvium, 2018). The study was completed in February 2018, on a natural section of North Wambo Creek, directly above future Longwalls 23, 24 and 25 (South Bates Extension Mine) and upstream of this area.

The reaches of North Wambo Creek and its upstream tributaries of Spring and Chalkers Creek were categorised in accordance with the River Styles Framework. The extent of North Wambo Creek is shown in **Figure 9**. Energy conditions in each of the reaches were assessed to inform the broader assessment and likely future trajectory of the geomorphic character, behaviour and condition of the waterway. The results of the hydraulic model are presented in **Table 12**.

A copy of the North Wambo Creek Baseline Report was provided to DPE Water in April 2018.

**Table 12: North Wambo Creek – Baseline Assessment Hydraulic Model Results\***

Parameter	Units	ARI	Diversion criteria*	Reach average hydraulic parameters							
				Chalkers Creek	Spring Creek	Reach 1	Reach 2	Reach 3	Diversion Stage 2	Diversion Stage 3	Downstream
Shear Stress	N/m <sup>2</sup>	2 year	<40	85.3	84.9	75.2	35.0	30.4	29.6	50.4	37.5
		50 year	<80	127.9	113.7	104.7	72.9	40.6	43.8	68.0	68.4
Stream Power	N/m.s	2 year	35-60	213.4	208.3	179.0	58.4	49.3	57.6	106.7	74.8
		50 year	80-150	437.8	364.1	326.9	192.0	87.0	107.2	173.9	195.7
Velocity	m/s	2 year	no vegetation <1.0	2.5	2.5	2.3	1.4	1.3	1.2	1.9	1.1
			with vegetation <1.5								
		50 year	<2.5	3.4	3.1	3.0	2.3	1.7	1.8	2.3	1.7

\* Source: Alluvium, 2015



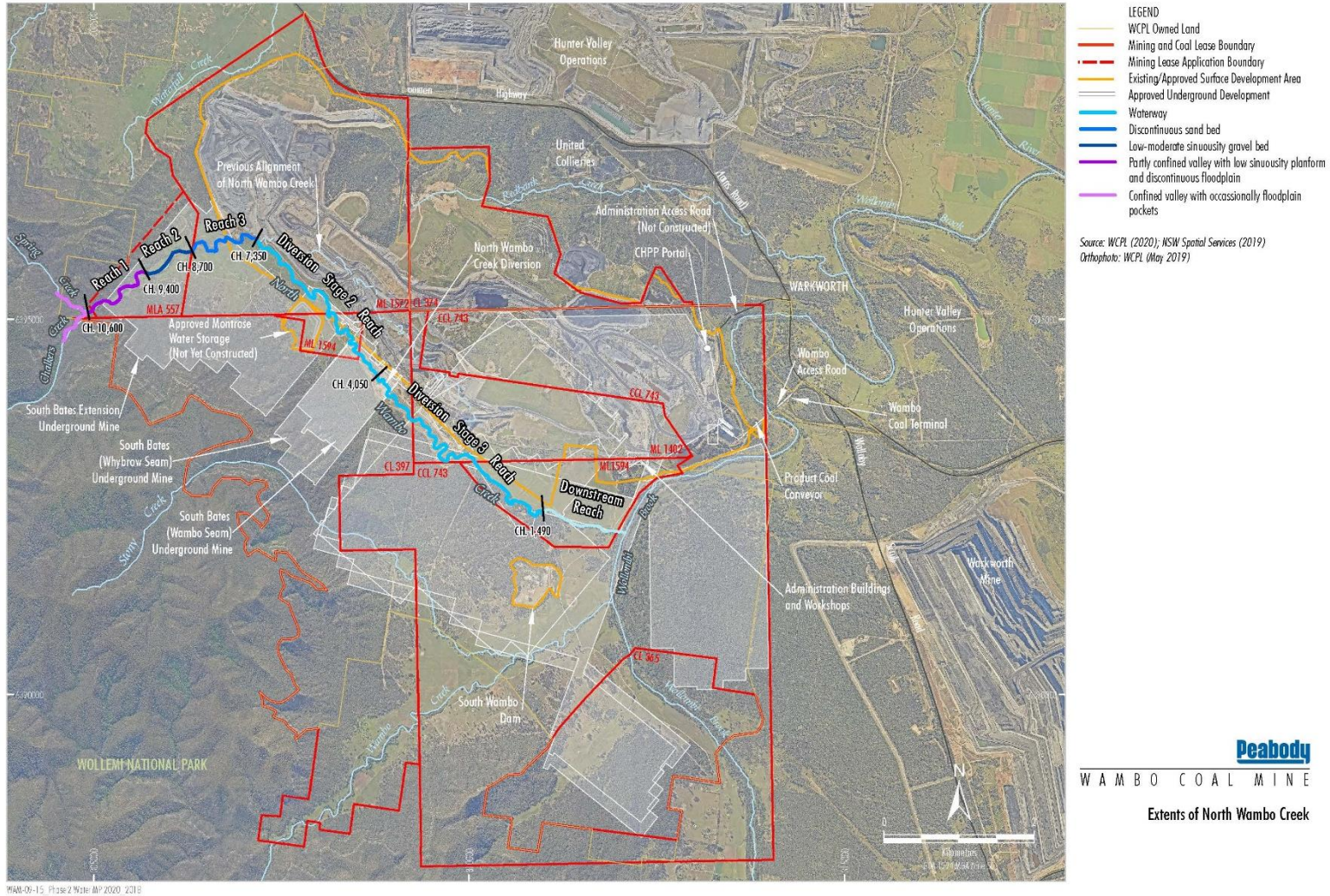

Figure 9: Extents of North Wambo Creek

### 3.5 Site Water Balance

A water balance model was initially developed for the Wambo water management system as part of the Wambo Development Project EIS studies in 2003 (June 2003). The model simulated inflows, outflows, transfers and changes in storage of water on site on a daily basis, under variable climatic conditions. This initial model adopted a number of simplifications including lumped consideration of site storages and other hydrological processes as well as a simple linear relationship to simulate runoff and seepage from rainfall on the various catchments and mine landforms.

A detailed water balance assessment was completed for the United Wambo Open Cut Project by Hydro Engineering and Consulting Pty Ltd (HEC) and forms an appendix to the Surface Water Assessment (Umwelt 2016a). Given the integrated nature of the United Wambo and Wambo water management systems, the water balance assessment included consideration of water use and make in the Wambo and United pits as well as the Wambo underground, CHPP and train loading facility.

The current GoldSim water balance model was developed by Jacobs in 2019 and is updated annually as part of a Peabody mine water governance initiative. Further details can be found in the **SWB**.

Condition B66, Schedule 2 of DA305-7-2003 requires annual preparation of an updated site water balance. The site water and salt balance will be recalculated on an annual basis and reported in the Annual Review (**Section 9.2.1**).

#### 3.5.1 Salt Balance

The sources of saline water at Wambo are:

- Surface water runoff – in addition to the salt released by weathering of the saline material, salt also accumulates by deposition from rainfall in soil. The salt on the surface of the soil or material is dissolved by rainfall and enters the WMS dissolved in runoff;
- Groundwater inflows into underground mine workings;
- water imported from other mines;
- water imported from the Hunter River and Wollombi Brook; and
- direct rainfall onto water storages.

Median salinity can be expected to increase over time and stabilise at approximately 3800mg/L throughout the operational forecast. An improvement in reported water quality is likely as catchments are rehabilitated. Further detail on the salt balance can be found in the **SWB**.

Monitoring will continue to be undertaken for water salinity (EC) in accordance with the surface water monitoring program detailed in **Section 6.0** and included in the **WMPProg**. Data from this monitoring program may be used to inform future salt balances for the site. The salt balance will be reviewed annually as part of the site water balance and reported in the Annual Review (**Section 9.2.1**).

## 4.0 Impact Assessment and Performance Criteria

Surface water impact assessment and performance criteria have been established for the following possible project related impacts:

- Reduction in flow due to catchment excision and loss of baseflow; and
- Degradation of surface water quality.

Performance criteria for riparian vegetation health is included in the Wambo **BMP**. Performance criteria/triggers for geomorphological response to flood events has been developed for the NWCD. This criteria is included in the **NWCD MP**.

Data from Wambo's surface water monitoring program will be compared against the established criteria. Details of the monitoring program are included in **Section 6.0**. Reporting requirements for this SWMP are detailed in **Section 9.2**.

A review of the data against the criteria will determine if the surface water impact investigation procedure or Trigger Action Response Plans (TARPs) in **Section 7.0** should be initiated. **Section 7.0** provides a protocol for the investigation, notification, and mitigation of identified exceedances of these assessment criteria.

### 4.1 Surface Water Impact Assessment Criteria

#### 4.1.1 Discharge Criteria

Mine water at Wambo is discharged through the EPL 529 licensed discharge point, located at Eagles Nest Dam (water quality monitoring site SW15) (**Figure 5**). Water quality discharge limits are drawn from EPL 529 and the HRSTS, as presented in **Table 13**.

**Table 13: Discharge Limits and Requirements**

Conditions		Source
Discharge Limits	No more than 250 ML/day will be discharged from the licensed discharge point/s.	Condition B55 of DA305-7-2003 & Condition L2.4 and L3.1 of EPL 529
	Discharges from any licensed discharge point must comply with the following limits: <ul style="list-style-type: none"> <li>• <math>6.5 \geq \text{pH} \leq 9.5</math>; and</li> <li>• Non-Filterable Residues (NFR)* <math>\leq 120</math> mg/L.</li> </ul>	
Discharge Requirements	Notification from Water NSW of discharge opportunity must be received.	HRSTS Guidelines
	Flow of water in Wollombi Brook at the Water NSW Bulga Gauging Station (FM1) needs to be more than 500 ML/day.	
	pH will to be measured continuously throughout the discharge with an inline instrument.	
	Conductivity (EC) will be measured continuously in $\mu\text{S/cm}$ throughout the discharge with a calibrated instrument designed to measure between 0 and 10,000 $\mu\text{S/cm}$ .	
	TSS will be measured once a day during discharge. A representative sample will be collected every day and sent to the lab for analysis.	

\*Equivalent to TSS

#### 4.1.2 Stream Flow

Wollombi Brook is perennial and the impact assessment criterion for Wollombi Brook has been set to zero flow at the Warkworth gauging station.

Flow impact assessment criteria for the local mine site ephemeral creeks are based on the unexpected absence of flow in climatic situations when flows would be expected. The impact assessment criteria would be met if there was no flow recorded at the flow monitoring site either on the day or the day after the recorded rainfall was equal to or greater than the nominated amount. The resulting runoff generating rainfall values are given in **Table 14**.

**Table 14: Surface Water Flow Impact Assessment Condition**

Watercourse and flow monitoring site	Daily rainfall when flow commenced on 80% of recorded occasions
Stony Creek – FM13	20 mm
South Wambo Creek – FM5	20 mm
North Wambo Creek – FM1	100 mm <sup>1</sup>

Notes to Table 14 -

1. Streamflow measurements in North Wambo Creek daily rainfall data from stations adjacent to the catchment have been analysed and indicate a total continuous rainfall depth of approximately 100mm (can occur over more than one day) is required to generate surface flow in North Wambo Creek upstream of the diversion

#### 4.1.3 Surface Water Quality

The impact assessment criteria for surface water quality are summarised in **Table 15**. Where actual site specific water quality monitoring data is available (**Section 3.3.1**) the criteria have been set based on the 20th and 80th percentile for the available dataset. Where insufficient data is available, WCPL has adopted the applicable ANZECC default guidelines values for slightly to moderately disturbed ecosystems or the NSW Water Quality Objectives for the Hunter River.

The high variability in TSS concentrations poses some difficulty in the selection of appropriate assessment criteria. Given the correlation between TSS and flow, separate impact assessment criteria have been set for 'low' and 'high' flow conditions. In this context the term low flow covers recessionary flows and flows generated by small to moderate flow events up to a 1 in 1 year average recurrence interval. The term high flow covers the rising stage of flow events and medium to large flow events e.g. 1 in 20 year average recurrence interval and larger.

**Table 15: Surface Water Quality Impact Criteria**

Sampling Site	Parameter	Lower Limit	Upper Limit
SW02 – Wollombi Brook	pH	7.4	8.1
	EC (µS/cm)	599	1947
	TSS (mg/L)	17 (low flow) – 308 (high flow) <sup>1</sup>	
SW05 – North Wambo Creek	pH	7.3	8.0
	EC (µS/cm)	1155	2350
	TSS (mg/L)	53 (low flow) – 1,110 (high flow) <sup>1</sup>	
SW07 – Wambo Creek	pH	7.4	7.9
	EC (µS/cm)	360	724
	TSS (mg/L)	29 (low flow) – 331 (high flow) <sup>1</sup>	
SW08 – Stony Creek <sup>5</sup>	pH	6.8	7.4
	EC (µS/cm)	288	416
	TSS (mg/L)	5 (low flow) – 15 (high flow) <sup>1</sup>	
SW39 Waterfall Creek	pH	7.3	7.9
	EC (µS/cm)	159	429
	TSS (mg/L)	582 (low flow) – 1,922 (high flow) <sup>1</sup>	

Notes to Table 15:

- <sup>1</sup> An exceedance occurs when water quality results exceed the Trigger Value after three consecutive sampling events or the surface flow impact assessment criteria are exceeded (refer to **Section 0** for TARP).

## 4.2 Surface Water Performance Criteria

Condition B62 of DA305-7-2003 (Modification 16) and Condition B9 of 177-8-2004 (Modification 3) require WCPL to comply with general water management performance measures (refer **Sections 2.2 and 0**). Performance indicators relevant to surface water are outlined in **Table 16**.

**Table 16: Surface Water Performance Criteria**

Aspect	Performance Measures	Performance Indicator/Trigger	Response
Downstream surface water quality	Negligible change in surface water quality (compared to predicted impacts)	<ul style="list-style-type: none"> <li>Surface water quality monitored is outside of the adopted trigger values (refer <b>Table 15</b>) for at least one parameter for more than two monitoring rounds.</li> </ul>	TARP – Surface water quality ( <b>Section 0</b> )
Channel stability	No increase in areas of instability within watercourses	<ul style="list-style-type: none"> <li>Channel stability monitoring indicates one or more areas of decreasing stability in watercourses.</li> </ul>	TARP – NWCD Performance ( <b>Section 7.3.1.5</b> )
Downstream flooding impacts	Negligible change in downstream flood access (compared to predicted impacts)	<ul style="list-style-type: none"> <li>No change to flood inundation of downstream properties in major flood events.</li> </ul>	Unforeseen Events Protocol ( <b>Section 7.3.4</b> )
Stream and riparian health	Riparian Health	<ul style="list-style-type: none"> <li>No evidence of significant weed growth or death of vegetation</li> </ul>	Unforeseen Events Protocol ( <b>Section 7.3.4</b> )
	Condition of channel	<ul style="list-style-type: none"> <li>No evidence of significant rill erosion, undercutting or slumping</li> </ul>	TARP – NWCD Performance ( <b>Section 7.3.1.5</b> )
	Deposition of sediment and debris	<ul style="list-style-type: none"> <li>No evidence of significant accumulation or deposition, large blockages in channel</li> </ul>	Unforeseen Events Protocol ( <b>Section 7.3.4</b> )
	General conditions	<ul style="list-style-type: none"> <li>No evidence of significant hazards presented to the public, poor aesthetics or feral animals, or geomorphic instability</li> </ul>	Unforeseen Events Protocol ( <b>Section 7.3.4</b> )
Surface Water User Supplies	Negligible impact to downstream surface water users (compared to predicted impacts)	<ul style="list-style-type: none"> <li>Mining extents / disturbance areas lie within approved boundaries.</li> <li>Surface water take associated with baseflow impacts is licensed.</li> <li>No complaints from downstream water users regarding loss of surface water (quality and/or quantity).</li> </ul>	TARP – Surface Water Flows ( <b>Section 7.3.1.1</b> )
Post-mining water pollution from rehabilitated areas of the site	Water discharged from the site is suitable for receiving waters and fit for aquatic ecology and riparian vegetation	<ul style="list-style-type: none"> <li>Runoff water quality from rehabilitation areas is within the range of water quality data recorded from analogue sites and/or baseline data and does not pose a threat to downstream water quality.</li> <li>Drainage structures (including drainage lines established in the final landform) are stable and there is no evidence of overtopping or significant scouring as a result of runoff</li> </ul>	Rehabilitation TARP (refer <b>RMP</b> )

#### 4.2.1 Channel Stability

Geomorphological triggers and success criteria were developed in 2007 as part of the detailed design of the North Wambo Creek Diversion (NWCD) (Gilbert and Associates, 2007). These triggers and criteria relate to the performance of the NWCD in flood conditions. This criteria is included in the **NWCD MP**. Channel stability performance criteria has not been established for other watercourses.

#### 4.2.2 Riparian Vegetation Health

Monitoring of riparian vegetation health is undertaken in accordance with the **BMP**. Performance criteria for riparian health is addressed in the **BMP**.

#### 4.2.3 Water Supply for Other Water Users

The surface water assessment for the United Wambo Open Cut Coal Mine project found that the project is likely to have minor to negligible impacts on water users relative to the current approved impacts immediately downstream of the mine (Umwelt 2016a). As such, triggers have not been established for specific water users however surface water flows and quality monitoring is undertaken in a number of watercourses, including in Wambo Creek, in accordance with **Section 6.0** and the **WMPProg**. Triggers have been established for these creeks (**Section 4.1**) and TARPs developed to respond to surface water impacts should they occur (**Section 7.3**).

#### 4.2.4 Post Mining Water Pollution from Rehabilitated Land

WCPL will monitor surface water impacts from operations during the life of the mine. Water runoff from rehabilitated land will be managed as part of the site water management system until such time as the rehabilitated land meets the rehabilitation closure criteria and is approved for relinquishment, as detailed in the **RMP**.

#### 4.2.5 Performance Indicators

The performance indicators in **Table 17** will be used to assess the performance of the Mine against the predicted impacts.

Table 17: Performance Indicators

Performance Indicator	Number
Number of complaints received relating to surface water	Nil
Number of non-compliances relating to surface water	Nil
Number of exceedances of surface water impact assessment criteria <sup>1</sup>	Nil
Number of reportable environmental incidents relating to surface water	Nil

Note:

1. An exceedance occurs when water quality results exceed the Trigger Values in **Section 4.1** after three consecutive sampling events (refer to **Section 7.0** for TARP)

WCPL will report on progress against these performance indicators in the Annual Review (**Section 9.2.1**). In the event that a complaint is received relating to surface water, it will be handled in accordance with the complaints management protocol (**Section 8.0**). Contingency plans for unpredicted surface water impacts are discussed in **Section 7.0**.

## 5.0 Surface Water Management Measures

Surface water management measures are implemented and monitored to ensure compliance with relevant statutory requirements. Management measures include, but are not limited to:

- Site water management system;
- Sewage Treatment Plant operation and maintenance;
- Chemical and Hydrocarbon Storage;
- Erosion and sediment control;
- Site Water Balance (and salt balance);
- Surface water monitoring program; and
- Decommissioning of redundant water management structures.

Specific management measures have also been developed for the Locomotive Provisioning Facility, adjacent to the Wambo rail loop (refer **Section 0**).

### 5.1 Site Water Management System

The site water management strategy for Wambo is based on the containment and re-use of mine water and on the control of sediment that may be potentially carried with runoff from disturbed areas such as the waste rock emplacements. The water management system (WMS) controls waters generated from development and operational areas while diverting upstream water around such areas. It includes both permanent structures that will continue to operate post-closure and temporary structures that will only be required until the completion of rehabilitation works. The WMS includes:

- Up-catchment diversion structures;
- Water storage dams;
- Sediment dams;
- Water transfer infrastructure (i.e. pumps and pipelines);
- Licenced Discharge Points; and
- The North Wambo Creek Diversion.

The WMS operates predominately as a closed, self-contained system. The water balance of the system fluctuates with climatic conditions and as the extent of the mining operations evolves over time.

An extensive reticulation system has been developed to transfer water between open cuts, underground operations and mine water storages, to source water from Wollombi Brook and the Hunter River, to facilitate controlled releases to Wollombi Brook (in accordance with EPL 529 and the Hunter River Salinity Trading Scheme) and to provide/accept water to the adjacent United Collieries operation.

A schematic of the site water management system is provided in **Figure 10**. **Figure 10** shows current storages and linkages and proposed storages. Not all storages and linkages may be present at any given point in time and the table on the left of **Figure 10** shows indicative start and end dates for applicable storages (for modelling purposes only). The water management system will be constructed and modified as and when required so as to support the required infrastructure and mine development. The water balance model (**Section 5.7**) has been developed based on **Figure 10**.

A table showing the water control structures onsite is included in the *ESCP*. The *ESCP* also contains a detailed description of the various classes of water onsite i.e. worked (or mine) water, surface (or dirty) water and diverted (or clean) water.



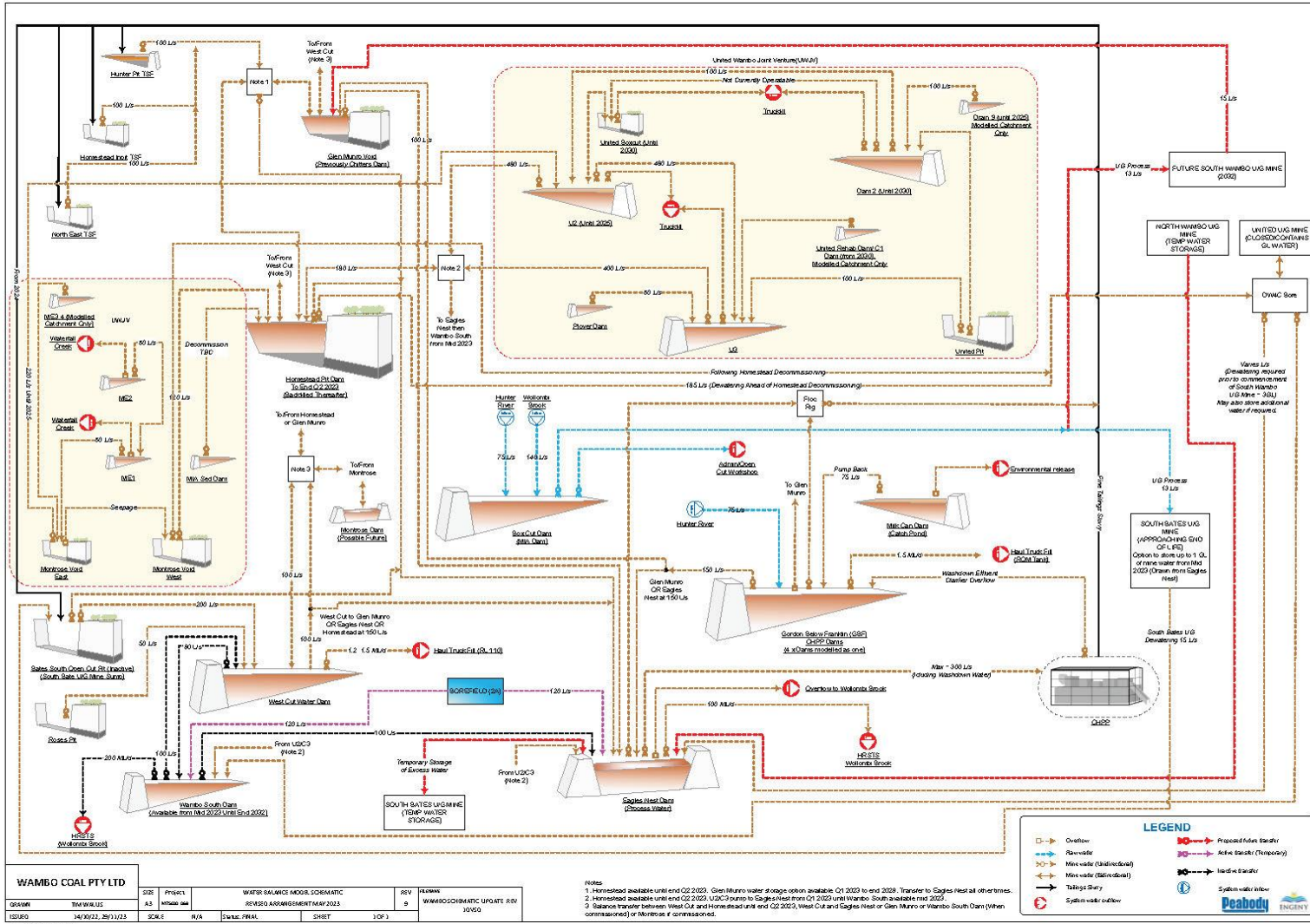

Figure 10: Water Management System (Engny, 2023)

### 5.1.1 Detailed Plans, Design Objectives and Performance Criteria

Detailed plans, design objectives and performance criteria have been developed for the North Wambo Creek Diversion. Further detail is provided in the **NWCD MP**, provided in Appendix A.

Sediment control structures are constructed in accordance with the guidelines presented in the Blue Book and design guidelines summarised in the **ESCP**.

Performance criteria have not been established for other water management infrastructure, with the exception of drainage networks in rehabilitated areas. These drainage networks are designed and constructed in accordance with the **RMP** and **ESCP** and performance is measured against completion criteria detailed in the **RMP**.

Further detail on the design, construction and maintenance of water management structures such as clean water diversions and sediment dams is included in the **ESCP**.

In accordance with Condition B62 of DA305-7-2003, all new water management infrastructure will be designed and constructed in consideration of the performance measures detailed in Table 8 of DA305-7-2003 (as modified) (refer **Table 2** in **Section 2.2**).

## 5.2 Water Supply and Water Sharing

WCPL is required to ensure that it has sufficient water for all stages of the development, and if necessary, adjust the scale of the development to match its available water supply. WCPL sources most of its water from rainfall runoff and dewatering of the underground mine.

WCPL may receive water from, and transfer water to, neighbouring mines including Hunter Valley Operations, Mount Thorley Warkworth and United Wambo open cut coal mine.

Water inflows and outflows, including any water shared, are reported annually as part of the site water balance (**Section 5.7**) and Annual Review (**Section 9.2.1**).

## 5.3 Prescribed Dams and Tailings

WCPL currently has three prescribed dams onsite:

- Wambo Hunter Pit Tails Dam;
- South Wambo Dam (currently decommissioned);
- North East Tailings Dam.

These dams were constructed prior to the approval of Modification 16 of DA305-7-2003, therefore the performance measures in Table 8 of DA305-7-2003 do not apply.

Hunter Pit Tails Dam and North East Tailings Dam are operated and maintained in accordance with an Operations and Maintenance Manual (OMM). A Dam Safety Emergency Plan (DSEP) has also been developed for both the Hunter Pit and North East Tailings Dams. When South Wambo Dam is recommissioned, an OMM and DSEP will be developed and implemented in line with the requirements of the *Dams Safety Act 2015*. Inspections include routine inspections, intermediate inspections (annually) and comprehensive inspections every 5 years.

WCPL must notify the NSW Dam Safety Committee when mining near prescribed dams. WCPL must also confirm the draining of the Wambo South Dam prior to commencement of secondary workings underneath.

Tailings deposition will cease at the Homestead Main Pit tailings storage facility (TSF) in late 2020. It is proposed that the South Bates Sump will be utilised in the future as a TSF.

#### 5.4 Sewage Treatment Plant Operation and Maintenance

WCPL operates and maintains an onsite sewage treatment plant (STP) to process waste from the mine infrastructure area. The STP is operated and maintained in accordance with manufacturers operating procedures and relevant conditions of EPL 529 (**Appendix C**).

WCPL has prepared a STP maintenance program in accordance with Condition O2.6 of EPL 529. This program includes quarterly service and maintenance conducted by a suitably qualified and experienced wastewater technician. The technician performs a full inspection of the STP and provides a written report including:

- Details of any maintenance undertaken;
- Results of any tests performed; and
- Details of actions required or recommended.

A copy of the quarterly maintenance reports and annual certification that the STP is operating within its capacity is submitted annually to the EPA with the EPL Annual Return (**Section 9.2.2**).

Effluent from the STP is discharged to land at WCPL's approved effluent irrigation area, in accordance with EPL conditions. Monitoring of the STP licensed discharge point (EPL ID No. 18, 42 and 52) is described in **Section 6.0**.

#### 5.5 Chemical and Hydrocarbon Storage

Chemical and hydrocarbon products are stored in bunded areas onsite, in accordance with the relevant Australian Standard. In the event that a chemical or hydrocarbon spill occurs, or a bund requires emptying, WCPL will arrange for removal of contaminated material from site using a licensed waste contractor. Pollution incidents will be managed in accordance with the Wambo **Pollution Incident Response Management Plan (PIRMP)**.

#### 5.6 Erosion and Sediment Control

WCPL is required to install and maintain erosion and sediment controls in accordance with the requirements of *Managing Urban Stormwater: Soils and Construction – Volume 1 (Landcom, 2004)* and *2E Mines and Quarries (DECC, 2008)*.

An Erosion and Sediment Control Plan (**ESCP**) has been developed and forms part of the Wambo Water Management Plan. Further detail on the management of erosion and sediment control is included in the ESCP. Monitoring of erosion and sediment controls is discussed in the **ESCP** and **Section 6.1.5** of this SWMP.

#### 5.7 Annual Site Water Balance and Salt Balance

A site water and salt balance will be completed each year as part of the Annual Review (**Section 9.2.2**). The site water and salt balance incorporates and assesses all of the data collated from the surface water and groundwater monitoring programs including surface water inflows, outflows and storage volumes.

## 5.8 Management of the Locomotive Provisioning Facility

The 2012 modification to the Wambo Rail Spur Consent (DA 177-8-2004) allowed for the construction of a Locomotive Provisioning Facility adjacent to the WCPL rail loop (Wells Environmental Services, 2011). The facility includes storage and handling facilities for 100,000L diesel, 2,000L oil, sand and water. Due to the environmental risk associated with storage of hydrocarbons, the following management measures will be implemented during the operation of the facility to minimise the potential for contamination of land, or water in Wollombi Brook.

### 5.8.1 Hydrocarbon Storage and Handling

The diesel storage tank is a double skinned self bunded diesel storage tank with a capacity of approximately 100,000L (Transtank T108E) with an extended pumping bay. The tank has a capacity of 108,000L and a safe fill of 95,000L. The oil tank is integrated into the double bunded storage structure.

The refilling facility incorporates several spill prevention features including a security card to activate the pump, a refill nozzle that must be connected to the fuel tank to flow, an operator dead man switch and a cut-off valve in the event of a ruptured pipe. The refuelling hose connects to the locomotive fuel tank using a Banlaw nozzle eliminating accidental spills. Oil is pumped via a low pressure pipeline into the locomotives via two retractable hose and trigger nozzles. These retractable hose reels are located above spill containment grates adjacent to the rail track.

### 5.8.2 Facility Site

The hydrocarbon storage and handling facility has been designed, is managed and maintained in accordance with *AS 1940-2004 The storage and handling of flammable and combustible liquids* and other associated standards. Spill containment kits are kept within a lockable onsite storage container.

All pumps and external equipment are locked, and a two metre high chain wire perimeter fence with lockable gate has been installed around the outside of the facility to deter unauthorised access, theft and vandalism.

Drip and spill control grates located at the two refill points and a bunded concrete area for tanker refilling are connected to a SPEL Purceptor™ oily water management system.

### 5.8.3 Water Treatment System

The SPEL Purceptor™ oily water management system is a full retention separator that treats flows from the three refill areas and is sized to contain more than the anticipated maximum oil and diesel spillage enabling it to be fully operational at all times. The system has a working capacity (the volume of water held before treated water discharges from the outflow) of 2050L with a treatment rate of up to 4L/s, and a spill capacity of a further 1,000L. With the small catchment area for the system (approximately 30m<sup>2</sup>), the system is capable of treating the equivalent of over 2,000mm of rainfall per hour.

The unit has an alarm signal that notifies management (via SMS) in the event of a spillage that is in excess of 10% of the spill capacity (i.e. 100L) or when progressive spillage reaches this capacity. No visible oil and grease is permitted to leave the site. Visible oil and grease in water is considered equivalent to a criterion of 10mg/L. Treated water from the system has levels of 5mg/L or less.

#### 5.8.4 Management Procedures

All personnel involved in the use of hydrocarbons on the site are trained in the appropriate use of facility and emergency response measures. Regular inspections, servicing and maintenance of the station, in addition to visual inspections by locomotive drivers during refuelling, are undertaken.

Absorbent spill control matting located between the tracks in the refuel area (absorbs approximately 12L/m<sup>2</sup>) will be replaced every 18 months or as required.

#### 5.9 Decommissioning of Water Management Structures

It is anticipated that the post-mining area would consist of safe and stable landform features, revegetated to a mixture of woodland and pasture areas, consistent with the **RMP**.

Water management structures and sediment control structures would either be retained as wetland habitat/water features or decommissioned and rehabilitated. The design, capacity and final location of these post mining water management structures will be refined and detailed in revised water management plans as the mine progresses towards mine closure. Some access roads may be retained post-mining to enable access for bushfire response and other land management activities.

If the Locomotive Provisioning Facility is retained until the end of Mine Life, the structures associated with the facility will be decommissioned simultaneously with the adjacent rail load out infrastructure. If decommissioning is required before the removal of the rail load out then all above-ground infrastructure will be removed, a contamination assessment completed, and the site rehabilitated to match the landuse in the immediate surrounding area.

#### 5.10 Inspections

Inspections of water management infrastructure, such as dams, sumps and sediment control structures, are undertaken in accordance with the Wambo Coal *Water Asset Management Plan*. Inspections enable WCPL to monitor the effectiveness of management measures implemented in **Section 5.10** of this SWMP and also the **ESCP**.

Inspections of the NWCD are also undertaken in accordance with the Extraction Plan monitoring schedule and include visual inspections for evidence of surface cracking and/or ponding.

#### 5.11 Auditing

Audits (both internal and external) will be undertaken to assess the effectiveness of environmental controls, compliance with this SWMP, consent conditions, and other relevant approvals, licenses, and guidelines.

Audit requirements are detailed in the **EMS**.

## 6.0 Surface Water Monitoring Program

The surface water monitoring program is designed to monitor surface water quality and levels to detect potential impacts on surrounding catchment users and to ensure that relevant legislative and policy requirements are met. Monitoring locations, parameters, frequency and methodology of monitoring are outlined in this section.

Data collected will:

- Be used in the continued development of surface water investigation triggers (**Section 4.1**); and
- Provide input to annual reviews of surface water monitoring data (**Section 9.2.1**) and the site water balance and salt balance (**Section 5.7**).

A general description of the surface water monitoring program for Wambo is included in this section. The surface water monitoring locations, parameters, frequency and methodology of monitoring for the Wambo Underground Mine (and United Wambo Open Cut Mine) are outlined in the combined *WMProg*.

### 6.1 Monitoring Network, Parameters and Frequency

Ongoing surface water monitoring requirements at Wambo are as follows:

- Monitoring of water quality including Wollombi Brook, North Wambo, South Wambo, and Stony Creeks (**Section 6.1.1**);
- Monitoring of mine water quality in mine water storage dams and sediment ponds (if applicable) (**Section 6.1.2**);
- Monitoring of flow in the North Wambo Creek, Stony Creek and South Wambo Creek (**Section 0**);
- Monitoring of water quality to assess the effectiveness of erosion and sediment control measures (**Section 6.1.5**);
- Monitoring of riparian vegetation and creek bed stability (**Section 6.1.6**);
- Monitoring discharge flows through the North Wambo Creek diversion; (**Section 6.1.7**);
- Monitoring of subsidence impacts on the North Wambo Creek diversion (**Section 6.1.8**);
- Monitoring of licenced discharges under EPL 529 and the HRSTS (**Section 6.1.9**);
- Monitoring of inflows into the underground and open cut workings (**Section 6.1.10**);
- Monitoring of water quality of sediment dams with potential for offsite discharge; and
- Monitoring of water supply for other water users (**Section 6.1.11**).

Water quality trigger values have been developed for a number of creeks and waterways. The results of monitoring of these creeks and waterways will be compared against the triggers in **Section 4.1**. Results of monitoring at the licenced discharge point will be compared against the criteria detailed in EPL 529 (**Section 4.1.1**). All required reporting will be undertaken in accordance with **Section 9.2**.

Mine water monitoring is undertaken for operational management purposes only. This data is not reported publicly.

### 6.1.1 Surface Water Quality

Sampling is undertaken at sites including Wollombi Brook, North Wambo, South Wambo, and Stony Creeks. Surface water quality monitoring is undertaken on a monthly basis and/or following a significant rainfall event (20 mm within 24 hours, midnight to midnight), with a new rainfall event considered to have commenced if there has not been a rainfall event in the previous 48 hours. Sampling is only undertaken during flow periods to ensure that increased solute concentration (caused by evaporation) does not cause incorrect sample results.

Water quality monitoring sites are generally located upstream and downstream of WCPL's operations, to distinguish mining impacts from natural water quality fluctuations. Redbank Creek is not monitored by WCPL, as downstream creek flow is used by United Collieries for operational purposes. Monitoring in Waterfall Creek (SW39) commenced in July 2007 to enable the collection of sufficient baseline data prior to the commencement of any potential mining within that catchment.

In response to comments from the IESC (July 2017), WCPL increased the sampling schedule to include monthly monitoring of metals and ions at six surface water monitoring locations (as outlined in **Table 8** (refer **Section 3.2**). The locations were chosen as representative sites surrounding WCPL operations, including upstream and downstream locations. The additional monitoring will be conducted until December 2020 to collect baseline data.

WCPL recorded exceedances of the surface water quality impact criteria during 2021 at SW02, SW05 and SW07 for pH and SW08 for Electrical Conductivity (EC). Umwelt Environmental Consultants undertook an investigation of the exceedances at SW02, SW05 and SW07 and concluded it is highly unlikely that operations at the Mine are related to the pH exceedances and that the exceedances are more likely the result of natural variation. No additional specific measures are proposed.

SLR Consulting conducted a Preliminary Investigation into the exceedance of EC at SW08 and concluded that high rainfall in March 2021 (following 301 mm of rainfall), is likely to have resulted in sufficient recharge to the shallow groundwater system to enable the migration of surface and shallow groundwater through fractures in bedrock or dilated bedding planes within the Newcastle Coal Measures underlying the creek. This has resulted in the observed change in water quality at SW08 when compared with historical data. A number of recommendations were made in the Preliminary Investigation Report (which was provided to DPE 28 March 2022), and have been implemented by WCPL. Investigations are ongoing.

WCPL will continue to review EC trends at SW08. Follow up reports have been provided to DPE in March and November 2023.

### 6.1.2 Mine Water Quality and Storage Levels

A number of mine water storage dams and pits are sampled monthly for water pH and EC. Data from this monitoring is used for operational purposes and is reported internally as required.

A number of key mine water storage dams are also monitored for water storage level. This data is used in the development of the annual Site Water Balance and Salt Balance (**Section 5.7**).

### 6.1.3 Surface Water Flows

WCPL monitors flow in the North Wambo Creek, Stony Creek and South Wambo Creek using continuous flow monitoring stations. Surface water flow monitoring data for Wollombi Brook is sourced from DPIE Water operated flow gauging stations, located at Warkworth (FM10) and Bulga (FM11).

The ephemeral nature of these creeks often results in extended no-flow periods. Available data from this monitoring is reported in the Annual Review (**Section 9.2.1**).

### 6.1.4 Sediment Dams

A number of sediment dams are monitored for pH, EC and TSS on a monthly basis. The surface water assessment for the United Wambo project found that the low risk of metal/metalloid contamination is considered to not warrant specific monitoring of these substances as part of the routine monitoring program for sediment dam water however any significant change in pH will trigger further analysis of metal/metalloid concentrations in runoff water (Umwelt, 2016a).

If a monitoring result indicates that there has been a significant change in pH (i.e. >1 pH unit) in a sediment dam with the potential to discharge, WCPL will take a follow up sample to confirm the result. If this second result shows a significant change in pH then WCPL will arrange for the sample to be analysed for metals/metalloids. Further monitoring may be undertaken depending on the results of this analysis.

### 6.1.5 Erosion and Sediment Control

As well as collecting background water quality data and identifying potential mining impacts, surface water quality monitoring sites are strategically located so as to enable the effectiveness of erosion and sediment control measures (implemented in accordance with the **ESCP**) to be assessed. Inspection, maintenance and management of erosion and sediment control structures is undertaken in accordance with the requirements of the **ESCP**, including:

- Inspections of sediment dams during construction at a frequency proportional to the level of risk.
- Inspections of sediment dams to verify dam walls, drainage channels, etc have been successfully stabilised by revegetation methods.
- Inspections of sediment control structures and sediment dams following runoff generating rainfall to determine whether dewatering and/or desilting is required to restore design settling zone capacity.

### 6.1.6 Riparian Vegetation and Creek Bed Stability

Localised bed and bank instability is a natural phenomenon in alluvial creeks, which contributes to the dynamic geomorphology of fluvial systems. Creek beds are also susceptible to subsidence induced erosion, due to the variable depth of subsidence associated with underground longwall mining.

The Baseline Riparian Vegetation and Bed Bank Stability Monitoring Program commenced in October 2006 to monitor for potential subsidence impacts. The program aims to distinguish natural erosion from mine subsidence associated instability, through pre-mining and post-mining survey of North Wambo Creek, South Wambo Creek and Stony Creeks.

A program to monitor riparian vegetation corridors along North Wambo, South Wambo and Stony Creeks has also been implemented. Details of both programs are presented in the **BMP** and **NWCD MP** (refer **Appendix D**).



### 6.1.7 Monitoring of Discharge Flows in the North Wambo Creek Diversion

Monitoring and reporting of discharge flows in the North Wambo Creek Diversion (NWCD) will be undertaken in accordance with DPE Water requirements. These requirements include the:

- Calculation of bankfull discharge flow capacities and velocities for the first discharge event following NWCD completion, and thereafter as directed by DPE Water;
- Assessment of diversion stability performance, compared with selected stable reaches of North Wambo Creek and other control catchments, as approved by DPE Water; and
- Reporting of NWCD monitoring data in the Annual Review (**Section 9.2.1**).

### 6.1.8 Diversion and Subsidence Monitoring Program

#### Operational Monitoring

An operational monitoring program for the NWCD commenced in 2017. Monitoring data collected in 2017 forms the baseline for future monitoring.

The program provides an assessment of the condition and condition trajectory of North Wambo Creek and the NWCD above the underground mining areas and adjacent upstream and downstream reaches. The outcomes of the monitoring program will inform recommendations to manage any identified issues with the condition of the NWCD, in particular management issues that may affect downstream receiving waters or WCPL infrastructure.

The operational monitoring requirements are summarised in **Table 18**. Monitoring locations are shown on **Figure 11**.

The results of the operational monitoring program and the geomorphic condition of the NWCD will be reviewed annually. This review will include an assessment of the efficacy of subsidence management or rehabilitation works and maintenance requirements.

#### Construction/Rehabilitation Monitoring

Monitoring will be undertaken annually along the NWCD to confirm that works have been undertaken to specification and/or meet design intent.

The following records will be maintained following the implementation of mitigation or rehabilitation works:

- Descriptions of the design activities completed.
- Photographs of the works taken during construction and immediately after the work is finished. Where possible photographs should be taken from fixed photo points, with details such as date, time and weather conditions noted.
- Aerial photography within 12 months after works are completed to accurately display the extent of change and provide a baseline reference for changes that may occur in the future.

## **Relinquishment Monitoring**

If the operational monitoring program indicates the operation of the NWCD is operating in dynamic equilibrium at or before mine closure, a relinquishment monitoring program would be developed.

With the implementation of planned remediation works, it is anticipated this will not be required as the diversion should have been operating for a minimum of 10 years and had flow events of sufficient frequency and magnitude to test the performance of the diversion and its response to subsidence.

**Table 18: Diversion and Subsidence Monitoring Program – Operational Monitoring**

Component	Locations	Parameters	Frequency
<ul style="list-style-type: none"> <li>Index of Diversion Condition (IDC)</li> </ul>	<ul style="list-style-type: none"> <li>Upstream reach (U1 – U4, UB - UF).</li> <li>NWCD Stage 2 (Div1 – Div5).</li> <li>NWCD Stage 3 (Div 6 – Div11).</li> <li>Above completed North Wambo Underground (WS1 – WS6).</li> <li>Downstream reach (D1 – D2).</li> </ul>	<ul style="list-style-type: none"> <li>Geomorphic Index<sup>1</sup> – based on width of high flow channel, active channel and low flow channel, bank condition, piping of banks, bed condition, spoil piles, recovery and in-stream structures.</li> <li>Riparian Index<sup>1</sup> – based on width of riparian zone, structural intactness, regeneration and longitudinal continuity.</li> <li>Six photos at each monitoring point:</li> <li>Upstream, cross-stream, downstream and away from stream – with the monitoring peg in the lower centre of the frame (where possible).</li> <li>In-channel bed upstream and downstream – from the centre of the creek bed (or as near as possible).</li> </ul>	<ul style="list-style-type: none"> <li>Annually<sup>2</sup></li> </ul>
<ul style="list-style-type: none"> <li>Landscape Function Analysis (LFA)</li> </ul>	<ul style="list-style-type: none"> <li>NWCD Stage 2 (17R, 19 R, 21R, 23R).</li> <li>NWCD Stage 3 (28R, 27R, 26R, 25R).</li> </ul>	<ul style="list-style-type: none"> <li>Landscape Organisation Index (LOI) (as outlined in the Biodiversity Management Plan).</li> <li>Soil Surface Assessment (as outlined in the Biodiversity Management Plan).</li> </ul>	<ul style="list-style-type: none"> <li>Annually</li> </ul>
<ul style="list-style-type: none"> <li>Riparian Vegetation</li> </ul>	<ul style="list-style-type: none"> <li>Same as IDC monitoring points.</li> </ul>	<ul style="list-style-type: none"> <li>Vegetation structure and extent.</li> </ul>	<ul style="list-style-type: none"> <li>Annually<sup>2</sup></li> </ul>
	<ul style="list-style-type: none"> <li>North Wambo Creek (8A, 9A, 10A, 11A, 12A, 13A, 14A, 15A).</li> </ul>	<ul style="list-style-type: none"> <li>Rapid Appraisal of Riparian Condition (RARC) index (as outlined in the Biodiversity Management Plan).</li> </ul>	<ul style="list-style-type: none"> <li>Annually</li> </ul>
<ul style="list-style-type: none"> <li>Aerial Photography</li> </ul>	<ul style="list-style-type: none"> <li>Full reach of NWCD and North Wambo Creek downstream.</li> </ul>	<ul style="list-style-type: none"> <li>Changes to channel form compared to previous aerial photographs.</li> </ul>	<ul style="list-style-type: none"> <li>Annually<sup>2</sup></li> </ul>

Component	Locations	Parameters	Frequency
<ul style="list-style-type: none"> <li>Long and Cross-Section Surveys (Bed and Bank Stability Monitoring).</li> </ul>	<ul style="list-style-type: none"> <li>Extracted from LiDAR or aerial photogrammetry survey data captured over NWCD and North Wambo Creek downstream.</li> </ul>	<ul style="list-style-type: none"> <li>Changes to channel form compared to previous surveys.</li> </ul>	<ul style="list-style-type: none"> <li>Annually<sup>2</sup></li> </ul>
<ul style="list-style-type: none"> <li>Surface Water Quality Data</li> </ul>	<ul style="list-style-type: none"> <li>As per <b>WMProg</b></li> </ul>		
<ul style="list-style-type: none"> <li>Flow Event Data</li> </ul>	<ul style="list-style-type: none"> <li>As per <b>WMProg</b></li> </ul>		

Notes to **Table 18:**

1. Based on ID&A Pty Ltd (2001).

2. Frequency may be reduced following the completion of subsidence from the South Bates Underground Mine.

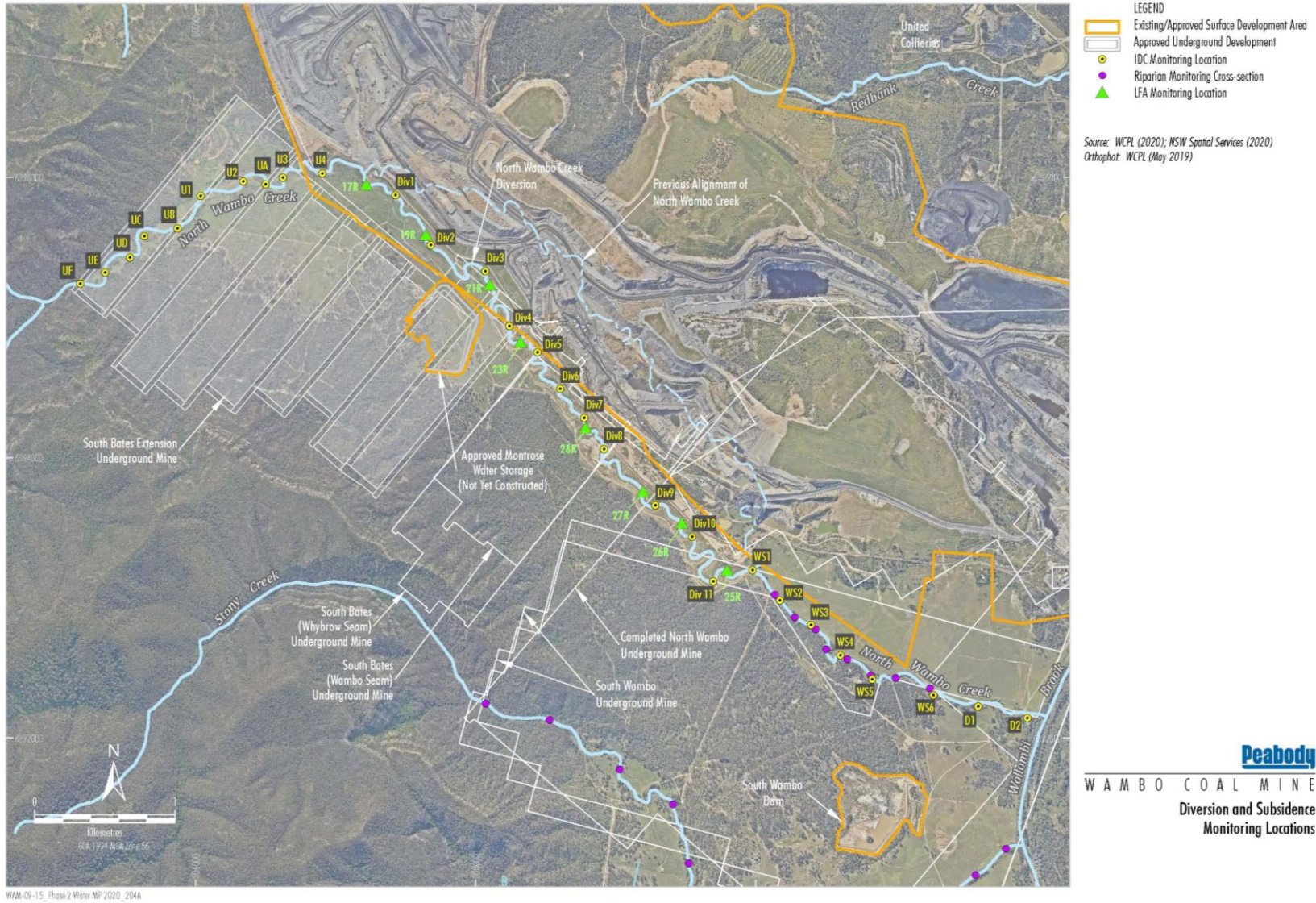

Figure 11: Diversion and Subsidence Monitoring Locations

### 6.1.9 Monitoring of Licensed Discharges under EPL 529 and the HRSTS

Wambo is required to monitor water quality and volume for licensed discharges at monitoring location SW15 (EPL ID No. 4) and SW53 (EPL ID No. 19) in accordance with the licensed discharge limits and requirements detailed in **Table 13** and relevant monitoring conditions of EPL 529 and the HRSTS (refer **Appendix C**). These monitoring requirements include:

- Ensuring continuous operation and maintenance of communication equipment which makes the conductivity and flow measurements taken available to the "Service provider" within one hour of those measurements being taken and makes them available in the format specified in the "*Hunter River Salinity Trading Scheme Discharge Point Site Equipment*" (DLWC, 2002);
- Ensuring that all monitoring data is within a margin of error of 5% for conductivity measurements and 10% for discharge flow measurement and
- Marking monitoring point EPL ID No. 4 (SW15) and EPA ID No. 19 (SW53) with signs which clearly indicates the name of the licensee, whether the monitoring point is up or down stream of the discharge point and that it is a monitoring point for the HRSTS.

### 6.1.10 Monitoring of Flows into Underground and Open Cut Mines

The water quality of inflows to the underground workings are measured indirectly through monthly water quality monitoring of mine water storages (refer **WMProg**). This is the most practical method to routinely sample for water quality.

An unexpected increase in water make or change in water quality of mine water storages would be investigated in consultation with United Wambo. If warranted, direct measurement of water quality at the source of inflow may be conducted.

Monitoring of flows into the open cut workings is undertaken by United Wambo in accordance with the United Wambo Water Management Plan.

Data from this monitoring is used for operational purposes and is reported internally as required. Data from this monitoring is also incorporated into the **SWB**.

### 6.1.11 Monitoring of Water Supply for Other Water Users

As the project is likely to have minor to negligible impacts on water users relative to the current approved impacts immediately downstream of the mine (Umwelt 2016a), no specific monitoring is proposed for other water users in addition to the monitoring program for surface water flows and quality monitoring detailed in **Sections 6.1.1 and 0** of this SWMP.

### 6.1.12 Water Balance Monitoring

As part of the site water balance monitoring, water imported to site, water used onsite and water discharged from site will be monitored in accordance with *Water Reporting Requirements for Mines* (NOW undated).

## 6.2 Sampling Methodology

Surface water quality sampling and analysis is conducted in accordance with *Approved Methods for Sampling and Analysis of Water Pollutants in New South Wales* (DEC, 2004); *Australian Standard/New Zealand Standard (AS/NZS) 5667:1998 Parts 1, 4 and 6*; and the requirements of the HRSTS.

### 6.3 Data Management Procedures

Validated data from the monitoring program will be entered into a digital database by an Environmental Advisor. This renders the data in a form suitable for analysis.

WCPL will record the following details for all surface water monitoring samples:

- The date(s) and times on which the sample was taken;
- The point at which the sample was taken; and
- The name of the person who collected the sample.

In the event of a suspected anomalous result, WCPL will conduct a re-test as soon as is practicable to do so.

### 6.4 Data Review and Investigation

Upon receipt of monitoring results, the following review processes will be undertaken:

- Data will be compared to the impact assessment criteria where applicable (**Section 4.0**).
- If result(s) do not meet impact assessment criteria a response procedure will be initiated in accordance with **Section 7.0**.

WCPL will undertake an annual review of monitoring data and compare the results to the surface water impact assessment criteria detailed in **Section 4.0**. Results of the review will be included in the Annual Review (**Section 9.2.1**).

When monitoring results exceed the impact assessment criteria or the annual review identifies surface water impacts, an investigation appropriate for the situation will be launched to determine the cause. The investigation will include comparison of monitoring results, meteorological patterns, mining activities and changes to land use. Further details outlining these response procedures are outlined in **Section 7.0**.

## 7.0 Surface Water Response Plan

### 7.1 Adaptive Management

Potential surface water impacts are detailed in the *Wambo Development Project Environmental Impact Statement* (EIS) (Wambo Coal, 2003), *The North Wambo Underground Mine Modification Environmental Assessment* (Resource Strategies, 2012) and the *United-Wambo Project Environmental Assessment* (Umwelt, 2016).

The Wambo Water Management Plan, of which this SWMP forms a part, has been developed to manage and monitor water related risks associated with the Wambo Coal Mine, to minimise the risk of exceedances of the criteria and/or performance measures detailed in the relevant development consents and licences. If an exceedance of these criteria and/or performance measures occurs, WCPL will, at the earliest opportunity:

- Take all reasonable and feasible steps to ensure that the exceedance ceases and does not recur;
- Consider all reasonable and feasible options for remediation (where relevant) and submit a report to DPIE describing those options and any preferred remediation measures or other course of action; and
- Implement remediation measures as directed by the Planning Secretary, to the satisfaction of the Planning Secretary.

### 7.2 Incident Definition

An incident is defined in DA305-7-2003 as:

*An occurrence or set of circumstances that causes or threatens to cause material harm and which may or may not be or cause a non-compliance.*

Incident reporting will be undertaken in accordance with **Section 9.2.4**.

### 7.3 Impacts on Surface Water

Surface water is monitored at over 20 locations across Wambo, including flow monitoring and water quality. Monitoring of mine water storage dams is also undertaken on a monthly basis. WCPL has developed a number of triggers for water quality and flow (refer **Section 4.0**). Licensed discharges from site must also meet the Discharge Criteria specified in EPL 529 (refer **Table 13**).

As detailed in Wambo's 2003 EIS, the potential surface water impacts include:

- Connective cracking between North Wambo Creek and the underground workings;
- Reduction in water quality due to increased sedimentation and potential EC impacts; and
- Reduction of contributing catchments to North Wambo Creek, Waterfall Creek and Redbank Creek due to open cut mining.

Connective cracking was identified in the EIS as the highest risk to surface water flows. However, there has been no evidence of connecting cracking following the subsiding of North Wambo Creek by Longwall panels 1 and 2. In 2008, prior to Longwall 1, a specific *North Wambo Creek Subsidence Response Strategy* (NWCSRS) was prepared in consultation with the Resource Regulator, EPA and DPIE.



If routine monitoring identifies evidence of potential surface water impacts, an investigation will be undertaken as soon as possible. The investigation will include a detailed review of relevant monitoring data trends and climatic information along with operational activities, to determine if the impact on surface water is a result of Wambo's activities.

If the investigation identifies actual surface water impacts and attributes those impacts to Wambo's activities, WCPL will implement the adaptive management process in **Section 7.0**. Appropriate remediation measures will be developed and implemented in consultation with relevant government agencies and affected landowners, as required.

The outcomes of this process will be reported in the Annual Review (**Section 9.2.1**). If an incident is deemed to have occurred (**Section 7.2**) WCPL will notify and report to DPIE and any other relevant government departments in accordance with **Section 9.2.4**.

### **7.3.1 Trigger Action Response Plans**

WCPL has developed a number of TARPs for impacts on surface water. These TARPs were developed and included in the **SGWRP**. As the **SGWRP** is no longer required under the modified DA305-7-2003 (Modification 16), WCPL has incorporated the relevant surface water TARPs into this SWMP. TARPs were developed in consultation with DPIE Water. Evidence of this consultation is included in **Appendix A**.

#### **7.3.1.1 Impacts on Surface Water Flows**

WCPL has developed a TARP that must be implemented in the event that:

- After rainfall exceeding 20mm in 24hr, visual observations during flow events within either South Wambo Creek or Stony Creek, identifies a potential variance in flow rates between upstream and downstream flow monitoring stations; or
- After rainfall exceeding 100mm in 24hr, visual observations during flow events within North Wambo Creek, identifies a potential variance in flow rates between upstream and downstream flow monitoring stations; or
- The initial calculated theoretical flow rates identifies a potential loss of flow between upstream and downstream flow monitoring stations within either North Wambo Creek, South Wambo Creek or Stony Creek.

This TARP is summarised in **Table 19**.

**Table 19: TARP for Impacts on Surface Water Flows**

TARP Code	Level 1 Response Management Measures	Level 2 Response Contingency Phase
Trigger	<ul style="list-style-type: none"> <li>•After rainfall exceeding 20mm in 24hr, visual observations during flow events within either South Wambo Creek or Stony Creek, identifies a potential variance in flow rates between upstream and downstream flow monitoring stations; or</li> <li>•After rainfall exceeding 100mm<sup>1</sup>, visual observations during flow events within North Wambo Creek, identifies a potential variance in flow rates between upstream and downstream flow monitoring stations</li> </ul>	<ul style="list-style-type: none"> <li>•The initial calculated theoretical flow rates identifies a potential loss of flow between upstream and downstream flow monitoring stations within either North Wambo Creek, South Wambo Creek or Stony Creek.</li> </ul>
Action	<ul style="list-style-type: none"> <li>•Confirm actual flow event by observing creek flows at upstream and downstream locations.</li> <li>•Download flow monitoring data from flow monitoring stations at the completion of the flow event.</li> <li>•Check flow monitoring equipment for functionality;</li> <li>•Review recent climatic conditions and rainfall data recorded from meteorological station.</li> <li>•Calculate theoretical flow rates from flow monitoring stations to compare upstream and downstream flow rates.</li> <li>•If the initial calculation of the theoretical flow rates identifies a potential loss of flow when comparing the upstream and downstream flow rates, then go to Level 2 Response.</li> </ul>	<ul style="list-style-type: none"> <li>•Maintain surface flow monitoring to identify if creek flow rates have returned to statistical trends.</li> <li>•Undertake preliminary investigation as soon as possible, including:               <ul style="list-style-type: none"> <li>-Engaging a suitable qualified hydrologist to confirm if a loss of the calculated theoretical flow rates between upstream and downstream flow monitoring stations has occurred;</li> <li>-Review location of rainfall event/s that may have contributed to creek flow variability within the creek catchment;</li> <li>-Check flow monitoring equipment for functionality;</li> <li>-Review pumping volumes from the South Bates Underground Extension Mine to examine pumping trends; and</li> <li>-Provide pumping volumes from underground workings to groundwater specialists for review.</li> </ul> </li> </ul>
Plan		<ul style="list-style-type: none"> <li>•If confirmation of a flow loss which is greater than modelled has occurred, Wambo will notify the relevant government agencies and in consultation develop appropriate measures to mitigate the loss of surface water flows in the surface water streams (e.g. stream remediation techniques) as soon as possible.</li> <li>•Review and update the WMP and resubmit to DPIE within 3 months, or as otherwise agreed.</li> </ul>

Notes to **Table 19**

1 As outlined in Table 14

### 7.3.1.2 Impacts on Surface Water Quality

WCPL has developed a TARP that must be implemented in the event that:

- Surface water monitoring of Wollombi Brook, North Wambo Creek, South Wambo Creek, Stoney Creek or Waterfall Creek for pH, EC and TSS, identifies water quality results exceeding the Trigger Value, as identified in **Table 14**, after two consecutive sampling events.

This TARP is summarised in **Table 20**.

**Table 20: TARP for Impacts on Surface Water Quality**

TARP Code	Level 1 Response Management Measures	Level 2 Response Contingency Phase
Trigger	<ul style="list-style-type: none"> <li>•Surface water monitoring of Wollombi Brook, North Wambo Creek, South Wambo Creek, Stoney Creek or Waterfall Creek for pH, EC and TSS, identifies water quality results exceeding the Trigger Value, as identified in <b>Table 14</b>, after two consecutive sampling events.</li> </ul>	<ul style="list-style-type: none"> <li>•Surface water monitoring of Wollombi Brook, North Wambo Creek, South Wambo Creek, Stoney Creek or Waterfall Creek for pH, EC and TSS, identifies water quality results exceeding the Trigger Value, as identified in <b>Table 14</b>, after three consecutive sampling events.</li> </ul>
Action	<ul style="list-style-type: none"> <li>•Increase monitoring of surface water site(s) to fortnightly to identify if water quality results are trending back to long term averages as identified in <b>Table 14</b>.</li> <li>•If any water quality exceeds the Trigger Value (three consecutive samples), then go to Level 2 Response.</li> </ul>	<ul style="list-style-type: none"> <li>•Maintain monitoring of surface water sites to identify if water quality results are trending back to long term averages as identified in <b>Table 14</b>.</li> <li>•Undertake preliminary investigation as soon as possible, including:               <ul style="list-style-type: none"> <li>-Determine contributing factors including meteorological conditions, if an incident has potentially occurred, review location of operational activities etc.</li> <li>-Where appropriate, engage a suitable qualified aquatic ecologist or similar to investigate the aquatic environment;</li> <li>-Increase monitoring frequency where relevant; and</li> <li>-Develop corrective/preventative actions based on the outcomes of the investigation and/or additional monitoring.</li> </ul> </li> </ul>
Plan		<ul style="list-style-type: none"> <li>•If confirmation of a results above confirms impacts to water quality have occurred as a direct result from Wambo's operations, WCPL will notify the relevant government agencies and in consultation develop appropriate remedial measures as soon as possible.</li> <li>•Review and update the WMP and resubmit to DPE within 3 months, or as otherwise agreed.</li> </ul>

### 7.3.1.3 Breach of EPL 529 Limits

WCPL has developed a TARP that must be implemented in the event that:

- Monitoring at the Licenced Discharge Point (LDP) confirms pH, EC, TSS or discharge volumes are approaching or have exceeded discharge limits as identified in **Table 13**; and/or
- There is potential evidence of an unauthorised discharge or an unauthorised discharge event has occurred; or
- Wambo has failed to monitor at the LDP as identified in the SWMP and EPL 529.

This TARP is summarised in **Table 21**.

**Table 21: TARP for Breach of EPL 529 Limits**

TARP Code	Level 1 Response Management Measures	Level 2 Response Contingency Phase
Trigger	<ul style="list-style-type: none"> <li>Monitoring at Licence Discharge Point (LDP) confirms pH, EC, TSS or discharge volumes are approaching discharge limits as identified in <b>Table 13</b>; and/or</li> <li>Potential evidence of an unauthorised discharge</li> </ul>	<ul style="list-style-type: none"> <li>A Level 2 Response has been triggered if:               <ul style="list-style-type: none"> <li>-Exceedance of EPL 529 pollution concentration limits;</li> <li>-Unauthorised discharge event has occurred;</li> <li>-Exceedance of EPL 529 discharge volume limit; or</li> <li>-Failure to monitor at LDP as identified in EPL 529.</li> </ul> </li> </ul>
Action	<ul style="list-style-type: none"> <li>Maintain monitoring at LDP to confirm pH, EC, TSS remain within discharge limits.</li> <li>Prepare to cease discharging:               <ul style="list-style-type: none"> <li>-If water quality values for pH, EC and TSS continue to trend towards an exceedance of their respective discharge water quality criteria; and</li> <li>-If daily discharge volumes continue to trend towards an exceedance of the daily discharge water volume criteria.</li> </ul> </li> <li>If there is an exceedance of the pH, EC, TSS criteria and/or discharge volume limit then go to Level 2 Response.</li> <li>If there is evidence of an unauthorised discharge go to Level 2 Response.</li> </ul>	<ul style="list-style-type: none"> <li>If monitoring at Licence Discharge Point (LDP) confirms any of the Level 2 Responses have been triggered, WCPL will:               <ul style="list-style-type: none"> <li>-Cease discharge immediately;</li> <li>-Initiate <b>PIRMP</b>;</li> <li>-Initiate an investigation to determine contributing factors including meteorological conditions, if an incident has potentially occurred, review location of operational activities, equipment failure etc;</li> <li>-Provide report within seven days to the EPA and DPIE and other relevant government agencies;</li> <li>-Increase monitoring frequency where relevant;</li> <li>-Develop corrective/preventative actions based on the outcomes of the investigation and/or additional monitoring; and</li> <li>-Undertake additional monitoring (stream health monitoring, etc.) if necessary.</li> </ul> </li> </ul>
Plan		<ul style="list-style-type: none"> <li>Implement appropriate contingency and remedial measures, including follow-up monitoring, auditing and advice from relevant government agencies.</li> <li>Communicate results of investigation and subsequent contingency and remedial measures to relevant government agencies.</li> <li>Review and update the WMP and SWMP and resubmit to DPIE within 3 months, or as otherwise agreed.</li> </ul>

#### 7.3.1.4 Impacts on North Wambo Creek Alluvium

WCPL has developed a TARP that must be implemented in the event that:

- Groundwater monitoring of standing water levels in the proposed replacement bores within the North Wambo Creek alluvium, identifies standing water trigger levels, beyond predicted modelled impacts; and/or
- Monitoring of aquatic ecosystems in accordance with the Biodiversity Management Plan identifies a potential or actual decline in aquatic health, beyond natural fluctuations; and/or
- Monitoring of Land Function Analysis (LFA) of riparian areas in accordance with the Biodiversity Management Plan identifies a potential or actual decline in creek stability, beyond natural fluctuations; and/or

This TARP is summarised in **Table 22**. This TARP is also supported by the TARP in the **GWMP** related to water licensing.

Table 22: TARP for Impacts on North Wambo Creek Alluvium

TARP Code	Level 1 Response Management Measures	Level 2 Response Contingency Phase
Trigger	<ul style="list-style-type: none"> <li>•Groundwater monitoring of standing water levels the proposed replacement bores within the North Wambo Creek alluvium, identifies a groundwater level below the minimum observed groundwater level during the first 12 months of monitoring; and/or</li> <li>•Monitoring of aquatic ecosystems in accordance with the <b>BMP</b> identifies a potential decline in aquatic health, beyond natural fluctuations; and/or</li> <li>•Monitoring of Land Function Analysis (LFA) of riparian areas in accordance with the <b>BMP</b> identifies a potential decline in creek stability, beyond natural fluctuations.</li> </ul>	<ul style="list-style-type: none"> <li>•Groundwater monitoring of standing water levels in the proposed replacement bores within the North Wambo Creek alluvium, identifies more than two consecutive groundwater levels below the minimum observed groundwater level during the first 12 months of monitoring; and/or</li> <li>•Monitoring of aquatic ecosystems in accordance with the <b>BMP</b> identifies a decline in aquatic health in consecutive monitoring events, beyond natural fluctuations; and/or</li> <li>•Monitoring of Land Function Analysis (LFA) of riparian areas in accordance with the <b>BMP</b> identifies a decline in creek stability in consecutive monitoring events, beyond natural fluctuations.</li> </ul>
Action	<ul style="list-style-type: none"> <li>•Maintain monitoring of bores within the North Wambo Creek alluvium, for standing water levels, to identify if decreasing trends have stabilised and bores display signs of increasing trends.</li> <li>•Review recent rainfall data to identify potential correlation between decreasing water level trends and extended dry periods.</li> <li>•Continue annual LFA and aquatic ecosystems monitoring to determine if decline trends have stabilised and displaying signs of improving trends in consecutive monitoring periods.</li> <li>•If standing water levels exceed standing water trigger values (consecutively) as provided in the <b>GWMP</b>, then go to Level 2 Response.</li> <li>•If consecutive LFA and aquatic ecosystems monitoring events show continued decline trends and are displaying no signs of improving trends, then go to Level 2 Response.</li> </ul>	<ul style="list-style-type: none"> <li>•Maintain monitoring of GW08.2, GW09.2, GW16 and GW17 within the North Wambo Creek alluvium, for standing water levels to identify if decreasing trends have stabilised and bores display signs of increasing trends.</li> <li>•Continue annual LFA and aquatic ecosystems monitoring to determine if decline trends have stabilised and displaying signs of improving trends in consecutive monitoring periods.</li> <li>•If decreasing standing water level trends are maintained and/or LFA and aquatic ecosystems are in decline and/or a significant increase of alluvium flows into the open cut has been identified, WCPL will undertake preliminary investigation, including:               <ul style="list-style-type: none"> <li>-Engage groundwater specialist to review relevant groundwater monitoring results in conjunction with site activities being undertaken at the time, baseline groundwater monitoring results, groundwater results at nearby locations, the prevailing and preceding meteorological conditions and changes to the landuse/ activities being undertaken in the contributing hydrogeological regime;</li> <li>-Review the site water balance and groundwater model;</li> <li>-Engage ecologist to review LFA and aquatic monitoring results in conjunction with site activities being undertaken at the time, the prevailing and preceding meteorological conditions and changes to the landuse/ activities being undertaken.</li> <li>-Develop corrective/preventative actions based on the outcomes of the investigation.</li> </ul> </li> </ul>
Plan		<ul style="list-style-type: none"> <li>•If investigation confirms impacts to alluvium are greater than modelled, WCPL will notify the relevant government agencies and in consultation develop appropriate remedial measures.</li> <li>•Develop corrective/preventative actions based on the outcomes of the investigation for example:               <ul style="list-style-type: none"> <li>-Secure additional water licences to account for the estimated future inflows (if applicable).</li> </ul> </li> <li>•Review and update the SWMP<sup>1</sup> and resubmit to DPIE within 3 months, or as otherwise agreed.</li> </ul>

Notes to Table 22:

1. **GWMP** and United Wambo Water Management Plans may also require review/revision and resubmission to DPE.

### 7.3.1.5 North Wambo Creek Diversion Performance Criteria

WCPL manages the North Wambo Creek Diversion in accordance with the **NWCD MP**. Management controls have been designed and implemented to minimise erosion and the potential for sediment generation and loss from the system however there is still a risk that erosion and sediment deposition may impact on North Wambo Creek water quality. Management controls are discussed in detail in the **ESCP** and the **NWCD MP**.

WCPL has developed a TARP that must be implemented in the event that:

- Surface water monitoring of North Wambo Creek, for pH, EC and TSS, identifies water quality results exceeding the Trigger Value, as identified in **Table 15** after two consecutive sampling events; and/or
- Monitoring of Land Function Analysis (LFA) of riparian areas in accordance with the **BMP** identifies a potential decline in creek stability, beyond natural fluctuations.

This TARP is summarised in **Table 23**.

**Table 23: TARP for North Wambo Creek Diversion Performance**

TARP Code	Level 1 Response Management Measures	Level 2 Response Contingency Phase
Trigger	<ul style="list-style-type: none"> <li>•Surface water monitoring of North Wambo Creek, for pH, EC and TSS, identifies water quality results exceeding the Trigger Value, as identified in <b>Table 15</b> after two consecutive sampling events; and/or</li> <li>•Monitoring of Land Function Analysis (LFA) of riparian areas in accordance with the <b>BMP</b> identifies a potential decline in creek stability, beyond natural fluctuations.</li> </ul>	<ul style="list-style-type: none"> <li>•Surface water monitoring of North Wambo Creek for pH, EC and TSS, identifies water quality result exceeding the Trigger Value, after three consecutive sampling events.</li> <li>•Monitoring of Land Function Analysis (LFA) of riparian areas in accordance with <b>BMP</b> identifies a decline in creek stability in consecutive monitoring events, beyond natural fluctuations.</li> </ul>
Action	<ul style="list-style-type: none"> <li>•Review recent rainfall data to identify potential correlation between decreasing water level trends and extended dry periods.</li> <li>•Continue annual LFA and aquatic ecosystems monitoring to determine if decline trends have stabilised and displaying signs of improving trends in consecutive monitoring periods.</li> <li>•Maintain monitoring of surface water sites to identify if water quality results are trending back to long term averages as identified in <b>Table 9</b>.</li> <li>•If consecutive LFA and aquatic ecosystems monitoring events show continued decline trends and displaying no signs of improving trends, then go to Level 2 Response.</li> <li>•If any water quality exceeds the 80th Percentile Trigger Value (three consecutive periods), then go to Level 2 Response.</li> </ul>	<ul style="list-style-type: none"> <li>•Continue annual LFA and aquatic ecosystems monitoring to determine if decline trends have stabilised and displaying signs of improving trends in consecutive monitoring periods.</li> <li>•Wambo will undertake preliminary investigation as soon as possible, including:               <ul style="list-style-type: none"> <li>-As above for Surface Water Quality</li> <li>-An investigation and engage ecologist specialist to review LFA monitoring results in conjunction with site activities being undertaken at the time, the prevailing and preceding meteorological conditions and changes to the landuse/ activities being undertaken.</li> </ul> </li> </ul>
Plan		<ul style="list-style-type: none"> <li>•If confirmation of a results and investigations from above confirms impacts, Wambo will notify the relevant government agencies and in consultation develop appropriate remedial measures if required.</li> <li>•Review and update the WMP and resubmit to DPIE within 3 months, or as otherwise agreed.</li> </ul>

### 7.3.2 Compensatory Water Supply

WCPL is required to provide a compensatory water supply to any landowner of privately-owned land whose rightful water supply is adversely and directly impacted (other than an impact that is minor or negligible) as a result of the development, in consultation with DPIE Water, and to the satisfaction of the Planning Secretary.

Compensatory water supply arrangements will be negotiated in consultation with the affected landowner(s) and DPIE Water as required, in accordance with Conditions B56 – B59 of DA305-7-2003.

### 7.3.3 Impacts on Groundwater Dependent Ecosystems or Riparian Vegetation

An aquatic ecosystems monitoring program has been developed to detect any potential changes in aquatic biology in accordance with the **BMP** within North Wambo Creek, Wambo Creek and Stony Creek and the North Wambo Creek Diversion.

Annual channel stability surveys are also undertaken to monitor the quantity and quality of riparian vegetation along North Wambo Creek and North Wambo Creek Diversion to determine the need for any maintenance and/or contingency measures (refer **Section 6.1.6**). This program and the development of stream health triggers (for water quality, stability and alluvium) are discussed in the **NWCD MP** and the **BMP**.

In the event that deterioration is identified in groundwater dependent ecosystems during stream health monitoring or annual channel stability surveys, the processes outlined above will be implemented.

### 7.3.4 Unforeseen Impacts

In the event that any unforeseen surface water impacts are detected, the following general response procedure will be initiated:

- Check and validate the data/information which indicates an unforeseen impact;
- Notify DPIE, EPA and other relevant agencies immediately after becoming aware of the impact;
- In the event of a suspected anomalous monitoring result, conduct a resample/retest where possible;
- Review the unforeseen impact, including consideration of:
  - Any relevant monitoring data; and
  - Current mine activities and land management practices in the relevant catchment, including other mining activities;
- Commission an investigation by an appropriate specialist into the unforeseen impact;
- Provide a preliminary investigation report to DPIE, EPA and relevant agencies within 7 days of identifying the unforeseen impact;
- Implement appropriate contingency/remedial measures;
- Implement additional monitoring to measure the effectiveness of the mitigation measures, where necessary;
- Communicate results of investigation and subsequent contingency and remedial measures to government agencies as required; and
- Review and update the WMP and SMWP and resubmit to DPIE.

#### 7.4 Failure to Comply with Other Statutory Requirements

Statutory requirements relating to this SWMP are summarised in **Section 2.0**. These requirements include compliance with DA305-7-2003, DA177-8-2004 and EPL 529.

WCPL monitors compliance with these statutory requirements on an ongoing basis, including during regular reviews and reporting of blast monitoring data and as part of Annual Reviews and compliance audits (e.g. Independent Environmental Audits).

In the event that WCPL identifies a failure to comply with a statutory requirement (other than those relating to unpredicted impacts – refer **Section 7.3**), WCPL will:

- Undertake an investigation into the failure;
- Identify suitable strategies or actions to be implemented to address the failure (and avoid a recurrence of the failure); and
- Report the non-compliance in accordance with the requirements of the development consents and EPL 529.



## 8.0 Community Complaint Response

All surface water related community complaints received by WCPL will be recorded within the Community Complaints Register. The Environment and Community (E&C) Manager (or delegate) will investigate the complaint, which will include, where possible, contacting the complainant within 24 hours to discuss the complaint. A review of the effectiveness of the corrective or preventative actions will be conducted within a month of the complaint and the relevant work procedures updated if required.

Preliminary investigations will commence as soon as practicable upon receipt of a complaint to establish if WCPL is responsible. All efforts will be made to determine the likely causes contributing to the complainant's concerns.

WCPL will attempt to address the complainant's concerns such that a mutually acceptable outcome is achieved. If a mutually beneficial outcome cannot be reached, WCPL may refer the matter to the Planning Secretary for resolution.

Details of all community complaints will be included in the Monthly Environmental Monitoring Report. WCPL will retain a copy of the Community Complaints Register for at least four years. The E&C Manager (or delegate) will ensure the latest Community Complaints Register is posted on the WCPL website.

## 9.0 Review and Reporting

### 9.1 Review

#### 9.1.1 Environmental Performance

The performance of the surface water monitoring program outlined in the SWMP be reviewed annually as part of the Annual Review (see **Section 9.2.1**).

#### 9.1.2 Management Plan Review

This SWMP will be reviewed, and if necessary revised, with any review of the **WMP** (refer Section 9.1 of the **WMP**).

The SWMP will reflect any changes in environmental requirements, technology, and operational procedures.

The revised SWMP will be re-submitted to the Secretary for approval as required by Condition B66 of DA305-7-2003.

### 9.2 Reporting

#### 9.2.1 Annual Review

The WCPL E&C Manager will be responsible for reporting any significant findings regarding the implementation of this SWMP in the WCPL Annual Review. The Annual Review report will include details of:

- results from the monitoring network;
- water extracted or discharged from the site, including water taken under each water licence;
- predictions versus actual results and licensing requirements; and
- any additional monitoring sites that may be required, or if optimisation of the existing monitoring sites, frequency of sampling and analytical suites should be undertaken.

Further detail on reporting for the Annual Review is included in Section 9.1 of the **WMP**.

Reporting on the performance of the North Wambo Creek diversion channel will also be included in the Annual Review, in accordance with DPIE Water requirements (**Table 6**).

#### 9.2.2 EPL 529 Annual Return

WCPL will prepare and submit an Annual Return in the approved form comprising a certified Statement of Compliance and a signed Monitoring and Complaints Summary to the EPA at the end of each EPL reporting period.

The Annual Return for the reporting period will be supplied to the EPA by registered post not later than 60 days after the end of each reporting period. WCPL will retain a copy of the Annual Return for a period of at least four years after the Annual Return was due to be supplied to the EPA.

The sewage treatment system maintenance program required by Condition O2.6 of EPL 529 (**Section 5.4**) will be submitted annually to the EPA with the Annual Return.

### **9.2.3 HRSTS Reporting**

WCPL will compile a written report of the activities under the HRSTS for each scheme year i.e. 1 July to 30 June. The written report will be submitted to the EPA' s regional office within 60 days after the end of each scheme year and will be in a form and manner approved by the EPA. The information will be used by the EPA to compile an annual scheme report.

### **9.2.4 Reporting of Incidents**

Reporting of environmental incidents will be undertaken in accordance with Section 9.2.4 of the **WMP**.

### **9.2.5 Reporting of Results**

A comprehensive summary of the surface water monitoring results will be made publicly available at WCPL's website (refer Section 9.2.7 of the **WMP**).

## 10.0 Responsibilities

**Table 24** below summarises responsibilities documented in the SWMP. Responsibilities may be delegated as required.

**Table 24: SWMP Responsibilities**

No	Task	Responsibility	Timing
1	Ensure inspections and surface water monitoring is undertaken in accordance with <b>Sections 5.10</b> and <b>6.0</b> .	Senior Environmental Advisor	As required
2	Assess surface water monitoring data against relevant criteria listed in <b>Section 4.0</b>	Senior Environmental Advisor	As required
3	Review SWMP in accordance with <b>Section 9.0</b> .	Senior Environmental Advisor	Annually
4	Undertake internal surface water reporting.	Senior Environmental Advisor	Monthly/Quarterly
5	Notify government departments if an incident occurs in accordance with <b>Section 9.2.4</b>	E&C Manager	As required
6	Submit updated SWMP to DPIE.	E&C Manager	As required
7	Surface water related complaints to be responded to in accordance with <b>Section 8.0</b>	E&C Manager	As required
8	Annual Review to include surface water monitoring results, complaints, mitigation measures undertaken and a review of the monitoring undertaken	E&C Manager	Annually
9	Regulator review to be undertaken of the SWMP	E&C Manager	As required
10	Prepare investigation reports and implementation of corrective actions in accordance with <b>Section 7.0</b>	E&C Manager	As required
11	Prepare and submit EPL Annual Return (including STP maintenance documents and results) in accordance with EPL 529.	E&C Manager	Annually
12	Prepare and submit HRSTS report for scheme year i.e. 1 July to 30 June in accordance with EPL 529.	E&C Manager	Annually (by end August)

## 11.0 References

- AECOM (2018) Report on Flow Events along North Wambo Creek, South Wambo and Stoney Creeks for the period 1 February 2017 to 31 January 2018
- Alluvium (2018) North Wambo Creek baseline assessment geomorphic context statement by Alluvium Consulting for Wambo Coal Pty Ltd.
- Australian and New Zealand Environment and Conservation Council (ANZECC) (2000) Australian and New Zealand Guidelines for Fresh and Marine Water Quality. Canberra.
- Development Consent (DA305-7-2003)
- Development Consent (DA177-8-2004)
- Geoterra (2005) United Collieries Pty Ltd Surface and Groundwater Monitoring to December 31 2004.
- Gilbert and Associates (2003) Wambo Development Project Surface Water Impact Assessment.
- Hansen Bailey (2018). Independent Environmental Audit Report for Wambo Coal Pty Ltd, September 2018.
- HEC (2016). United Wambo Open Cut Coal Mine Project Surface Water Assessment Water Balance Report, Prepared for Umwelt (Australia) Pty Ltd.
- HLA-Envirosciences Pty Ltd (1999) Effect of Longwall Panel 9 Mining on Surface and Groundwater – Homestead Underground Mine Warkworth NSW.
- ID&A Pty Ltd (2001) Monitoring & Evaluation Program for Bowen Basin River Diversions. Australian Coal Association Research Program (ACARP) Project C9068.
- Mackie Environmental Research (MER) (2002), Extension of Warkworth Coal Mine Assessment of Environmental Impacts Surface & Groundwater Management Studies, on behalf of Warkworth Mining Limited.
- Resource Strategies (2003) Wambo Development Project Aquatic Assessment.
- Umwelt (2016). United Wambo Open Cut Coal Mine Project Environmental Impact Statement
- Umwelt (2016a). United Wambo Open Cut Coal Mine Project Surface Water Assessment, July 2016
- Wambo Environment Protection Licence (529)
- Wambo Development Project Environmental Impact Statement (EIS), July 2003
- WCPL (2008) North Wambo Creek Subsidence Response Strategy
- Wells Environmental Services (2011) Modification of DA 177-8-2004, Environmental Assessment, Locomotive Refuelling Station - Wambo Coal Rail Loop

## APPENDIX A: Evidence of Consultation



Nicole Dobbins  
Senior Environmental Advisor  
Wambo Coal Mine  
PMB 1  
Singleton NSW 2330

20/11/2020

Dear Ms Dobbins

**Wambo Coal Mine (DA 305-7-2003-i)  
Water Management Plan**

I refer to the Wambo Water Management Plan (WMP), submitted in accordance with condition B66 of the approval for the Wambo Coal Mine (DA 305-7-2003-i). I understand that revisions to the WMP are required prior to Phase 2 of operations between the Wambo Coal Mine and United Wambo Joint Venture, which are scheduled to start on 1 December 2020.

I note that the WMP includes the following sub – plans:

- Site Water Balance;
- Salt Balance;
- Erosion and Sediment Control Plan;
- Surface Water Management Plan (including the North Wambo Creek Diversion Management Plan);
- Groundwater Management Plan; and
- Water Monitoring Plan.

The Department notes that the Site Water Balance, Salt Balance and Water Monitoring Program cover both the Wambo Coal Mine and United Wambo Joint Venture operations.

The Department has carefully reviewed the WMP and is satisfied that it adequately addresses the relevant requirements of the approval. Accordingly, the Planning Secretary has approved the WMP (Revision 2, November 2020) for Phase 2 of the operations. Please continue to operate in accordance with the previously approved WMP until Phase 2 commences.

Please also ensure that the approved plan is placed on the project website at the earliest convenience. If you wish to discuss the matter further, please contact Melanie Hollis on 8217 2043.

Yours sincerely

A handwritten signature in black ink, appearing to read 'M Sprott'.

Matthew Sprott  
Director  
Resource Assessments (Coal & Quarries)

as nominee of the Planning Secretary



Ms Nicole Dobbins  
Senior Environmental Advisor  
Wambo Coal Pty Ltd  
PMB 1  
Singleton, NSW, 2330

02/09/2020

Dear Ms Dobbins

**Wambo Coal Mine (DA 305-7-2003)  
Endorsement of Water Expert**

I refer to your letter dated 13 August 2020, requesting the Planning Secretary's approval of a suitably qualified person to prepare the Water Management Plan, required by condition B66 of the Wambo Coal Mine Development Consent (DA 305-7-2003).

This plan includes several sub-management plans including a Site Water Balance, Surface Water Management Plan, Monitoring Program, Groundwater Management Plan and Erosion and Sediment Control Plan. I also note that it is proposed to combine the Wambo and United Wambo (SSD 7142) Site Water Balance and Monitoring Program under condition A23(d). These joint aspects of the Water Management Plan would be prepared by Chris Bonomini from Umwelt Australia.

I note that previously endorsed experts for Wambo, Ms Claire Stephenson and Dr Noel Merrick from SLR and Mr Rohan Lucas from Alluvium will remain the endorsed experts for groundwater and the North Wambo Creek Diversion.

The Department has reviewed the nomination and information you have provided and is satisfied that all four experts are suitably qualified and experienced. Consequently, I can advise that the Planning Secretary approves the additional appointment of Chris Bonomini to prepare the relevant sections of the Water Management Plan alongside the existing endorsed experts.

If you wish to discuss the matter further, please contact Sarah Clibborn on (02) 82 896 184 or via email at [sarah.clibborn@planning.nsw.gov.au](mailto:sarah.clibborn@planning.nsw.gov.au).

Yours sincerely

A handwritten signature in black ink, appearing to read 'M Sprott'.

Matthew Sprott  
Director  
Resource Assessments (Coal & Quarries)

as nominee of the Planning Secretary





Nicole Dobbins  
Senior Environmental Advisor  
Wambo Coal Pty Ltd  
PMB 1  
Singleton NSW 2330

28/05/2020

Dear Ms Dobbins

**Wambo Coal Mine (DA 305-7-2003)  
Approval of Experts**

I refer to your correspondence of 23 April, requesting the Secretary's approval of suitably qualified persons to prepare the following environmental management plans for the Wambo Coal Mine (DA 305-7-2003):

- Air Quality and Greenhouse Gas Management Plan, required by condition B46; and
- Groundwater Management Plan required by condition B66(v).

The Department has reviewed the nominations and information you have provided and is satisfied that the following experts are suitably qualified and experienced:

- Shane Lakmaker (Jacobs) – Air Quality; and
- Claire Stephenson (SLR Consulting) – Groundwater.

I note that the Department recently approved the following experts to prepare the Wambo Extraction Plan for Longwalls 21 – 22:

- Dr Noel Merrick, (SLR Consulting) – Groundwater;
- Mr Rohan Lucas, (Alluvium) – Surface water;
- Mr Peter Kuskie, (South East Archaeology) – Aboriginal Cultural heritage; and
- Mr Martin Sullivan, (Eco Logical Australia) – Biodiversity.

The Department is satisfied that these experts are also suitably qualified and experienced to assist in the preparation of site environmental management plans in their field of expertise.

If you wish to discuss the matter further, please contact Melanie Hollis on 8217 2043.

Yours sincerely

A handwritten signature in black ink, appearing to read 'M Sprott'.

Matthew Sprott  
Director  
Resource Assessments (Coal & Quarries)  
as nominee of the Secretary



Mr Peter Jaeger  
Environment and Community Manager  
Wambo Coal Pty Limited  
PMB 1  
Singleton NSW 2330

28/02/2020

Dear Mr Jaeger

**Wambo Coal Project (DA 305-7-2003)  
Endorsement of Experts**

I refer to your letter dated 11 February 2020, requesting the Secretary's approval of suitably qualified persons to prepare the Extraction Plan for Longwalls 21 to 24 for the Wambo Coal Project (DA 305-7-2003).

The Department has reviewed the nominations and information you have provided and is satisfied that these experts are suitably qualified and experienced. Consequently, I can advise that the Secretary approves the appointment of the following experts to prepare the Extraction Plan for Longwalls 21 to 24:

- Mr Joshua Hunt (Resource Strategies) - Extraction Plan preparation;
- Mr James Barbato (Mine Subsidence Engineering Consultants) - Subsidence;
- Mr Rohan Lucas (Alluvium) - Surface Water;
- Dr Noel Merrick (SLR Consulting) - Groundwater;
- Mr Martin Sullivan (Eco Logical Australia) – Biodiversity; and
- Mr Peter Kuskie (South East Archaeology) - Aboriginal cultural heritage.

In relation the upcoming revisions of complex-wide management plans, to align with the commencement of United Wambo Phase 2, it is recommended that the Department's Water Group is consulted on this approach.

If you wish to discuss the matter further, please contact Melanie Hollis on 8217 2043.

Yours sincerely

A handwritten signature in black ink, appearing to read 'M Sprott'.

Matthew Sprott  
A/Director  
Resource Assessments (Coal & Quarries)

as nominee of the Planning Secretary

**Summary of Historic Stakeholder Consultation i.e. for WCPL's Surface Water Monitoring Program  
(versions 8 to 12)**

SWMP Version	Consultation
8	<ul style="list-style-type: none"> <li>Version 8 provided to DPIE Water, Resource Regulator (formerly DRE), EPA and DPIE as part of an Extraction Plan submission in October 2015.</li> <li>Comments were received from DPIE in October 2015.</li> <li>Comments were received from DPIE Water in November 2015.</li> </ul>
9	<ul style="list-style-type: none"> <li>Version 9 was approved by DPIE in November 2015.</li> </ul>
10	<ul style="list-style-type: none"> <li>Version 10 was provided to DPIE Water and EPA in December 2016 for consultation.</li> <li>Version 10 was provided to DPIE Water, Resource Regulator, EPA and DPIE as part of an Extraction Plan submission in January 2017.</li> <li>Comments were received from DPIE in May 2017 and July 2017.</li> <li>No comments were received from DPIE Water, Resource Regulator or EPA.</li> </ul>
11	<ul style="list-style-type: none"> <li>Version 11 was submitted to DPIE for approval as a component of the Extraction Plan for South Bates Underground LW11-16.</li> <li>DPIE Water provided comments in correspondence dated 17 December 2017.</li> <li>In providing advice on MOD 17 to DA 305-7-2003, the Independent Expert Scientific Committee (IESC) made comments in correspondence dated 31 July 2017.</li> </ul>
12	<ul style="list-style-type: none"> <li>Version 12 of the SWMP, which addressed IESC and DPIE comments following MOD17 approval and included a Summary of Commitments, was submitted to DPIE for approval in March 2018, as a component of the Extraction Plan for South Bates Underground Extension LW17-20.</li> <li>Version 12 was approved on 4 June 2019.</li> </ul>

**Consultation for this SWMP  
(For Phase 2 Activities at the Wambo Coal Mine)**

Stakeholder	Consultation
DPIE	Copy of draft Version 1, prepared for the commencement of Phase 2 activities at the Wambo Coal Mine provided to the DPIE via the DPIE - Major Projects Planning Portal 26 August 2020. Minor comments were received 18 November 2020 and are addressed in Version 2.
EPA	Copy of draft Version 1, prepared for the commencement of Phase 2 activities at the Wambo Coal Mine provided to the EPA 26 August 2020 via the DPIE - Major Projects Planning Portal. The EPA provided correspondence dated 4 September 2020 advising that it is not the role of the EPA to review management plans. No further comments received.
DPIE Water	Copy of draft Version 1, prepared for the commencement of Phase 2 activities at the Wambo Coal Mine provided to the DPIE Water via the DPIE - Major Projects Planning Portal 26 August 2020. DPIE requested the WMP be sent directly to <a href="mailto:nrar.servicedesk@industry.com.au">nrar.servicedesk@industry.com.au</a> . A copy of the WMP was sent to NRAR 31 August 2020. No comments have been received.



DOC20/707501-2

Wambo Coal Pty Ltd  
134 Jerrys Plains Road  
WARWORTH NSW 2330

Returned via the Major Projects Portal

4 September 2020

Dear Sir/Madam

**Wambo Open Cut Coal Mine Draft Water Management Plan (DA305-7-2003-i-PA-26)**

Reference is made to your request on 28 August 2020 via the Department of Planning, Industry and Environment's major projects portal requesting the Environment Protection Authority (EPA) to review and comment on the draft Wambo Coal Mine Water Management Plan (WMP), Doc No. WA-ENV-MNP-509 incorporating Site Water Balance, Wambo erosion and sediment control plan, surface water management plan and groundwater management plan.

The EPA encourages the development of such plans to ensure that licensees have determined how they will meet their statutory obligations and designated environmental objectives.

Being a regulatory authority, the EPA's role is to set environmental management objectives rather than being directly involved in the development of strategies to achieve those objectives. Accordingly, the EPA has not reviewed this management plan.

If you have any questions about this matter, please contact Jenny Lange on 02 4908 6891 or by email to [hunter.region@epa.nsw.gov.au](mailto:hunter.region@epa.nsw.gov.au)

Yours sincerely

A handwritten signature in black ink, appearing to read 'Jock Duncan'.

**JOCK DUNCAN**  
Acting Unit Head  
Regulatory Operations Regional North

Phone 131 555  
Phone 02 9995 5555  
(from outside NSW)

TTY 133 677, then  
ask for 131 155

Locked Bag 5022  
PARRAMATTA  
NSW 2124

4 Parramatta Square  
12 Darcy Street  
PARRAMATTA NSW  
2150

[info@epa.nsw.gov.au](mailto:info@epa.nsw.gov.au)  
[www.epa.nsw.gov.au](http://www.epa.nsw.gov.au)  
ABN 43 692 285 758

## **APPENDIX B: SWMP Summary of Commitments**

## Surface Water Management Plan (SWMP) (Version 1) – Summary of Commitments

**Note: The list of commitments in this appendix is in addition to those explicitly required by Development Consent or EPL conditions.**

SWMP Section	Commitment	Timing
1.3.1	The status of the <b>NWCD MP</b> will be reviewed during future SWMP updates.	During future SWMP updates
3.5	The site water balance will be recalculated on an annual basis and reported in the Annual Review.	Annually
3.5.1	Monitoring will continue to be undertaken for water salinity (EC) in accordance with the surface water monitoring program detailed in <b>Section 6.0</b> and included in the <b>WMPProg</b> . Data from this monitoring program may be used to inform future salt balances for the site.	As per <b>WMPProg</b>
	The salt balance will be reviewed annually as part of the site water balance and reported in the Annual Review.	Annually
4.0	Data from Wambo's surface water monitoring program will be compared against the established criteria. A review of the data against the criteria will determine if the surface water impact investigation procedure or Trigger Action Response Plans (TARPs) in <b>Section 7.0</b> should be initiated.	Ongoing
4.1.1	Mine water is discharged through the EPL 529 licensed discharge point, in accordance with the water quality discharge limits and requirements presented in <b>Table 13</b> .	Ongoing
4.2.4	WCPL will monitor surface water impacts from operations during the life of the mine. Water runoff from rehabilitated land will be managed as part of the site water management system.	Ongoing
4.2.5	WCPL will report against the following performance indicators in the Annual Review : <ul style="list-style-type: none"> <li>• Number of complaints relating to surface water;</li> <li>• Number of non-compliances relating to surface water;</li> <li>• Number of exceedances of surface water impact assessment criteria;</li> <li>• Number of reportable environmental incidents relating to surface water.</li> </ul>	Annually
	In the event that a complaint is received relating to surface water, it will be handled in accordance with the complaint's management protocol ( <b>Section 8.0</b> ).	As required
5.2	Water inflows and outflows, including any water shared, are reported annually as part of the Site Water Balance and Annual Review.	Annually
5.3	If/when South Wambo Dam is recommissioned, an OMM and DSEP will be developed and implemented in line with the requirements of the <i>Dams Safety Act 2015</i> .	If/when required
	WCPL will notify the NSW Dam Safety Committee when mining near prescribed dams.	Prior to mining near prescribed dams
	WCPL will confirm the draining of the Wambo South Dam prior to commencement of secondary workings underneath.	Prior to undermining
5.4	A copy of the quarterly maintenance reports and annual certification that the STP is operating within its capacity is submitted annually to the EPA with the EPL Annual Return.	Annually
5.5	Chemical and hydrocarbon products are stored in bunded areas onsite, in accordance with the relevant Australian Standard.	Ongoing

SWMP Section	Commitment	Timing
	In the event that a chemical and hydrocarbon spill occurs, or a bund requires emptying, WCPL will arrange for removal of contaminated material from site using a licensed waste contractor.	As required
	Pollution incidents will be managed in accordance with the <b>PIRMP</b> .	As required
5.7	A Site Water Balance will be completed each year as part of the Annual Review. A Salt Balance will also be prepared annually and reported in the Annual Review.	Annually
5.8	Implement management measures to address the risk of hydrocarbon storage at the Locomotive Provisioning Facility.	As required
5.8.4	All personnel involved in the use of hydrocarbons on the site are trained in the appropriate use of facility and emergency response measures.	Ongoing
	Complete monthly inspections, servicing and maintenance of the locomotive station along with visual inspections completed by locomotive drivers during refueling.	Monthly
	Replace absorbent spill control matting located between the tracks in the refuel area approximately every 18 months or as required.	As Required
5.9	The design, capacity and final location of these post mining water management structures will be refined and detailed in revised water management plans as the mine progresses towards mine closure.	Towards mine closure
5.10	Inspections of water management infrastructure, such as dams, sumps and sediment control structures, are undertaken in accordance with the Sediment Control Structure Checklist in the <b>ESCP</b> .	As per <b>ESCP</b>
	Inspections of the NWCD are also undertaken in accordance with the Extraction Plan monitoring schedule and include visual inspections for evidence of surface cracking and/or ponding.	As per Extraction Plan monitoring schedule
5.11	Audits (both internal and external) will be undertaken to assess the effectiveness of environmental controls, compliance with this SWMP, consent conditions, and other relevant approvals, licenses, and guidelines. Audit requirements are detailed in the <b>EMS</b> .	As per <b>EMS</b>
6.0	Data collected will: <ul style="list-style-type: none"> <li>• Be used in the continued development of surface water investigation triggers; and</li> <li>• Provide input to annual reviews of surface water monitoring data and the site water balance and salt balance.</li> </ul>	As required
6.1	Surface water monitoring will be conducted as outlined in <b>Section 6.0</b> and the <b>WMProg</b> .	Ongoing
	Monitoring results from creeks and waterways will be compared against the triggers in <b>Section 4.0</b> .	Ongoing
	The results of monitoring at the licenced discharge point will be compared against the EPL 529 criteria.	Following discharge
	Mine water monitoring is for operational purposes only and is not reported publicly.	Ongoing
	Data from the surface water monitoring is reported in the Annual Review.	Annually
6.1.1	Surface water quality monitoring will be conducted during flow periods, monthly and following more than 20 mm of rainfall in 24 hours.	As required
6.1.2	A number of mine water storage dams and pits are sampled monthly for water pH and EC. Data from this monitoring is used for operational purposes and is reported internally as required.	Monthly

SWMP Section	Commitment	Timing
	A number of key mine water storage dams are also monitored for water storage level. This data is used in the development of the annual Site Water and Salt Balance.	Ongoing
6.1.3	Flow monitoring on the Wambo Creek and North Wambo Creek, and Wollombi Brook (by DPIE Water) will continue to be undertaken on a continuous basis. The flow monitoring will be undertaken by Wambo, although this data will be shared with United.	Ongoing
6.1.4	A number of sediment dams are monitored for pH, EC and TSS on a monthly basis.	Monthly
	Any significant change in pH (in sediment dams) will trigger further analysis of metal/metalloid concentrations in runoff water.	As required
	If a monitoring result indicates that there has been a significant change in pH (i.e. >1 pH unit) in a sediment dam with the potential to discharge, WCPL will take a follow up sample to confirm the result. If this second result shows a significant change in pH then WCPL will arrange for the sample to be analysed for metals/metalloids. Further monitoring may be undertaken depending on the results of this analysis.	As required
6.1.5	Inspections of erosion and sediment control structures will be completed as outlined in the <b>ESCP</b> .	As required
6.1.6	Monitoring of riparian vegetation corridors and bed bank stability along North Wambo, South Wambo and Stony Creeks will be completed as outlined in the <b>BMP</b> .	Annually or as required
6.1.7	Monitoring and reporting of discharge flows in the North Wambo Creek Diversion (NWCD) will be completed in accordance with DPIE Water requirements and reported in the Annual Review.	Annually
6.1.8	The Diversion and Subsidence Monitoring Program ( <b>Table 18</b> ) will commence from 2017, the outcomes of which will inform recommendations to manage any identified issues with the condition of the NWCD.	As required
	Results of the operational monitoring program and the geomorphic condition of the NWCD will be reviewed annually.	Annually
	During implementation or mitigation rehabilitation works, records will be maintained including: <ul style="list-style-type: none"> <li>• Description of activities;</li> <li>• Photographs (preferably from fixed photo points); and</li> <li>• Aerial photography within 12 months after works are completed.</li> </ul>	Ongoing
6.1.10	WCPL will investigate any unexpected increase in water make or change in water quality of mine water storages and if warranted, commence direct measurement of water quality at the source of inflow.	As required
6.1.12	Water imported to site, water used onsite and water discharged from site will be monitored in accordance with <i>Water Reporting Requirements for Mines</i> (NOW undated).	Ongoing
6.3	Validated data from the monitoring program will be entered into a digital database by an Environmental Advisor.	Ongoing
6.4	Monitoring results will be compared to impact assessment criteria and if they do not meet the criteria, a response procedure will be initiated.	Ongoing
7.2	Incident reporting will be undertaken in accordance with <b>Section 8.6</b> .	As required
7.3	WCPL will respond to identified surface water impacts in accordance with the procedures and TARPs and processes described in <b>Section 7.3</b> .	As required



SWMP Section	Commitment	Timing
7.4	In the event that WCPL identifies a failure to comply with a statutory requirement, WCPL will: <ul style="list-style-type: none"> <li>• Undertake an investigation into the failure;</li> <li>• Identify suitable strategies or actions to be implemented to address the failure (and avoid a recurrence of the failure); and</li> <li>• Report the non-compliance in accordance with the requirements of the development consents and EPL 529.</li> </ul>	As required
8.0	Surface water related community complaints will be recorded within the Community Complaints Register.	As required
8.0	Surface water related community complaints will be reported in the Monthly Environmental Monitoring Report.	Monthly
9.1.1	Review Wambo's performance against management measures outlined in the SWMP as part of the Annual Review	Annually
9.1.2	Review and, if necessary, revise the SWMP with any review of the <b>WMP</b> . Resubmit to DPIE as required.	As required
9.2.1	Report any significant findings regarding the implementation of this SWMP in the WCPL Annual Review.	Annually
	Report details of any incidents or non-compliances relating to surface water in the WCPL Annual Review.	Annually
	Reporting on the performance of the North Wambo Creek diversion channel in the Annual Review, in accordance with DPIE Water requirements ( <b>Table 6</b> ).	Annually
9.2.4	Report incidents as per the <b>WMP</b> .	As required

## **APPENDIX C: EPL Conditions relevant to this SWMP**

EPL 529 Condition	Requirements			Section	
P1.2	The following points referred to in the table are identified in this licence for the purposes of monitoring and/or the setting of limits for discharges or pollutants to water from the point.			<b>Section 6.0 and WMProg</b>	
	<b>EPA ID No</b>	<b>Type of Monitoring Point</b>	<b>Type of Discharge Point</b>		<b>Location Description</b>
	4	Discharge to waters, water quality & volumetric monitoring	Discharge to waters, water quality & volumetric monitoring		EPA4' HRSTS Outlet from Eagles Nest Dam at 313133, 6393073 (Easting Northing)
	19	Discharge to waters, water quality & volumetric monitoring	Discharge to waters, water quality & volumetric monitoring		EPA19 HRSTS Discharge from South Wambo Dam at 311904, 6391464 (Easting and Northing)
	24	Ambient water quality monitoring			'SW1' at 314429, 6385707 (Easting, Northing)
	25	Ambient water quality monitoring			'SW2' at 314376, 6385037 (Easting, Northing)
	26	Ambient water quality monitoring			'SW3' at 312509, 6392866 (Easting, Northing)
	27	Ambient water quality monitoring			'SW4' at 306887, 6396024 (Easting, Northing)
	28	Ambient water quality monitoring			'SW5' at 311927, 6392157 (Easting, Northing)
	29	Ambient water quality monitoring			'SW6' at 309056, 6389550 (Easting, Northing)
	30	Ambient water quality monitoring			'SW7' at 311263, 6390718 (Easting, Northing)
	31	Ambient water quality monitoring			'SW8' at 308536, 6392133 (Easting, Northing)
	33	Ambient water quality monitoring		'SW15' at 313055, 6393097 (Easting, Northing)	

EPL 529 Condition		Requirements				Section
	34	Ambient water quality monitoring			'SW27a' at 309431, 6393558(Easting, Northing)	
	36	Ambient water quality monitoring				
	39	Ambient water quality monitoring				
	40	Ambient water quality monitoring				
	41	Ambient water quality monitoring				
	42	Ambient water quality monitoring				
	43	Ambient water quality monitoring				
	52	Ambient water quality monitoring				
	55	Ambient water quality monitoring				
	56	Ambient water quality monitoring				
L1.1	Except as may be expressly provided in any other condition of this licence, the licensee must comply with section 120 of the Protection of the Environment Operations Act 1997.					<b>Noted</b>
L2.1	For each monitoring/discharge point or utilisation area specified in the table/s below (by a point number), the concentration of a pollutant discharged at that point, or applied to that area, must not exceed the concentration limits specified for that pollutant in the table.					<b>Noted</b>
L2.2	Where a pH quality limit is specified in the table, the specified percentage of samples must be within the specified ranges.					<b>Noted</b>
L2.3	To avoid any doubt, this condition does not authorise the pollution of waters by any pollutant other than those specified in the table/s.					<b>Noted</b>
L2.4	Water and/or Land Concentration Limits					<b>Section 4.1</b>
	<b>Pollutant</b>	<b>Units of Measure</b>	<b>50 percentile concentration limit</b>	<b>90 percentile concentration limit</b>	<b>3DGM percentile concentration limit</b>	<b>100 percentile concentration limit</b>
	pH	pH				6.5-9.5
	Total Suspended Solids	Milligrams per litre				120
L3.1	For each discharge point or utilisation area specified below (by a point number), the volume/mass of: <ul style="list-style-type: none"> <li>a) Liquids discharged to water; or</li> <li>b) Solids or liquids applied to the area</li> </ul>					<b>Section 4.1</b>

EPL 529 Condition	Requirements	Section						
	<p>Must not exceed the volume/mass limit specified for that discharge point or area.</p> <table border="1" data-bbox="315 288 1059 379"> <thead> <tr> <th data-bbox="315 288 546 331">Point</th> <th data-bbox="553 288 775 331">Unit of Measure</th> <th data-bbox="781 288 1059 331">Volume/Mass limit</th> </tr> </thead> <tbody> <tr> <td data-bbox="315 336 546 379">4</td> <td data-bbox="553 336 775 379">Megalitres per day</td> <td data-bbox="781 336 1059 379">250</td> </tr> </tbody> </table>	Point	Unit of Measure	Volume/Mass limit	4	Megalitres per day	250	
Point	Unit of Measure	Volume/Mass limit						
4	Megalitres per day	250						
O2.2	The licensee is responsible for the correct operation of the sewage treatment system on their premises.	<b>Section 5.4</b>						
O2.3	Correct operation involves regular supervision and system maintenance. The licensee must be aware of the system management requirements and must ensure that the necessary service contracts are in place.							
O2.4	The sewage treatment system must be serviced by a suitably qualified and experienced wastewater technician at least once in each quarterly period and a minimum of four times per year.							
O2.5	The licensee must record each inspection and any actions required or recommended by the technician including all results of tests performed on the sewage treatment system by the technician as required in Condition O2.4.							
O2.6	<p>The licensee must prepare a sewage treatment system maintenance program. The program must include:</p> <ul style="list-style-type: none"> <li>a) Certification from the system provider that the sewage treatment system is operating within its capacity;</li> <li>b) Date, time and results of all routine maintenance procedures undertaken to the sewage treatment system; and</li> <li>c) Provide written records of each quarterly inspection.</li> </ul>							
O4.1	Effluent application must not occur in a manner that causes ponding or surface runoff.							
O4.2	Spray from the effluent application must not drift beyond the boundary of the effluent discharge utilisation area.							
O4.3	<p>The quantity of effluent/solids applied to the utilisation area must not exceed the capacity of the area to effectively utilise the effluent/solids. For the purpose of this condition, 'effectively utilise' include the use of the effluent/solids for pasture or crop production, as well as the ability of the soil to absorb the nutrient, salt, hydraulic load and organic material.</p>							
O4.4	The licensee must ensure that the effluent discharge utilisation area perimeter is fenced and signposted "Effluent Re-Use Area Keep Out" and controlled in a manner to ensure the exclusion of persons from that area.							
M1.1	The results of any monitoring required to be conducted by this licence or a load calculation protocol must be recorded and retained as set out in this condition.		<b>Section 6.3</b>					
M1.2	<p>All records required to be kept by this licence must be:</p> <ul style="list-style-type: none"> <li>a) in a legible form, or in a form that can readily be reduced to a legible form;</li> <li>b) kept for at least 4 years after the monitoring or event to which they relate took place; and</li> <li>c) produced in a legible form to any authorised officer of the EPA who asks to see them.</li> </ul>							
M1.3	<p>The following records must be kept in respect of any samples required to be collected for the purposes of this licence:</p> <ul style="list-style-type: none"> <li>a) the date(s) on which the sample was taken;</li> </ul>							

EPL 529 Condition	Requirements	Section																															
	b) the time(s) at which the sample was collected; c) the point at which the sample was taken; and d) the name of the person who collected the sample.																																
M2.1	For each monitoring/discharge point or utilisation area specified below (by a point number), the licensee must monitor (by sampling and obtaining results by analysis) the concentration of each pollutant specified in Column 1. The licensee must use the sampling method, units of measure, and sample at the frequency, specified opposite in the other columns:	Section 6.0 and WMProg																															
M2.3	Water and/ or Land Monitoring Requirements <b>POINT 4</b> <table border="1" data-bbox="405 544 1682 834"> <thead> <tr> <th>Pollutant</th> <th>Units of measure</th> <th>Frequency</th> <th>Sampling Method</th> </tr> </thead> <tbody> <tr> <td>Conductivity</td> <td>microsiemens per centimetre</td> <td>Continuous during discharge</td> <td>A probe designed to measure the range 0 to 10,000 uS/cm</td> </tr> <tr> <td>pH</td> <td>pH</td> <td>Continuous during discharge</td> <td>In line instrumentation</td> </tr> <tr> <td>Total suspended solids</td> <td>milligrams per litre</td> <td>Daily during any discharge</td> <td>Grab sample</td> </tr> </tbody> </table> <b>POINT 9</b> <table border="1" data-bbox="405 911 1682 1139"> <thead> <tr> <th>Pollutant</th> <th>Units of measure</th> <th>Frequency</th> <th>Sampling Method</th> </tr> </thead> <tbody> <tr> <td>Conductivity</td> <td>microsiemens per centimetre</td> <td>Every 2 months</td> <td>Grab sample</td> </tr> <tr> <td>pH</td> <td>pH</td> <td>Every 2 months</td> <td>Grab sample</td> </tr> <tr> <td>Total suspended solids</td> <td>milligrams per litre</td> <td>Every 2 months</td> <td>Grab sample</td> </tr> </tbody> </table>		Pollutant	Units of measure	Frequency	Sampling Method	Conductivity	microsiemens per centimetre	Continuous during discharge	A probe designed to measure the range 0 to 10,000 uS/cm	pH	pH	Continuous during discharge	In line instrumentation	Total suspended solids	milligrams per litre	Daily during any discharge	Grab sample	Pollutant	Units of measure	Frequency	Sampling Method	Conductivity	microsiemens per centimetre	Every 2 months	Grab sample	pH	pH	Every 2 months	Grab sample	Total suspended solids	milligrams per litre	Every 2 months
Pollutant	Units of measure	Frequency	Sampling Method																														
Conductivity	microsiemens per centimetre	Continuous during discharge	A probe designed to measure the range 0 to 10,000 uS/cm																														
pH	pH	Continuous during discharge	In line instrumentation																														
Total suspended solids	milligrams per litre	Daily during any discharge	Grab sample																														
Pollutant	Units of measure	Frequency	Sampling Method																														
Conductivity	microsiemens per centimetre	Every 2 months	Grab sample																														
pH	pH	Every 2 months	Grab sample																														
Total suspended solids	milligrams per litre	Every 2 months	Grab sample																														

EPL 529 Condition	Requirements	Section												
	<p><b>POINT 18</b></p> <table border="1" data-bbox="405 308 1686 501"> <thead> <tr> <th>Pollutant</th> <th>Units of measure</th> <th>Frequency</th> <th>Sampling Method</th> </tr> </thead> <tbody> <tr> <td>Faecal Coliforms</td> <td>colony forming units per 100 millilitres</td> <td>Quarterly during discharge</td> <td>Grab sample</td> </tr> <tr> <td>pH</td> <td>pH</td> <td>Quarterly during discharge</td> <td>Grab sample</td> </tr> </tbody> </table>	Pollutant	Units of measure	Frequency	Sampling Method	Faecal Coliforms	colony forming units per 100 millilitres	Quarterly during discharge	Grab sample	pH	pH	Quarterly during discharge	Grab sample	
Pollutant	Units of measure	Frequency	Sampling Method											
Faecal Coliforms	colony forming units per 100 millilitres	Quarterly during discharge	Grab sample											
pH	pH	Quarterly during discharge	Grab sample											
M3.2	Subject to any express provision to the contrary in this licence, monitoring for the concentration of a pollutant discharged to waters or applied to a utilisation area must be done in accordance with the Approved Methods Publication unless another method has been approved by the EPA in writing before any tests are conducted.	<b>Noted</b>												
M5.1	<p><b>Recording of pollution complaints</b></p> <p>The licensee must keep a legible record of all complaints made to the licensee or any employee or agent of the licensee in relation to pollution arising from any activity to which this licence applies.</p>	<b>Section 8.0</b>												
M5.2	<p>The record must include details of the following:</p> <ul style="list-style-type: none"> <li>a) the date and time of the complaint;</li> <li>b) the method by which the complaint was made;</li> <li>c) any personal details of the complainant which were provided by the complainant or, if no such details were provided, a note to that effect;</li> <li>d) the nature of the complaint;</li> <li>e) the action taken by the licensee in relation to the complaint, including any follow-up contact with the complainant; and</li> <li>f) if no action was taken by the licensee, the reasons why no action was taken.</li> </ul>	<b>Noted</b>												
M5.3	The record of a complaint must be kept for at least 4 years after the complaint was made.	<b>Section 8.0</b>												
M5.4	The record must be produced to any authorised officer of the EPA who asks to see them.	<b>Noted</b>												
M6.1	<p><b>Telephone Complaints Line</b></p> <p>The licensee must operate during its operating hours a telephone complaints line for the purpose of receiving any complaints from members of the public in relation to activities conducted at the premises or by the vehicle or mobile plant, unless otherwise specified in the licence.</p>	<b>Section 8.0</b>												
M6.2	The licensee must notify the public of the complaints line telephone number and the fact that it is a complaints line so that the impacted community knows how to make a complaint.	<b>Section 8.0</b>												
M7.1	<p><b>Requirement to monitor volume or mass</b></p> <p>For each discharge point or utilisation area specified below, the licensee must monitor:</p> <ul style="list-style-type: none"> <li>a) the volume of liquids discharged to water or applied to the area;</li> </ul>	<b>Section 6.0 and WMPProg</b>												

EPL 529 Condition	Requirements	Section						
	b) the mass of solids applied to the area; c) the mass of pollutants emitted to the air; at the frequency and using the method and units of measure, specified below. <b>POINT 4</b> <table border="1" data-bbox="327 395 1420 523"> <thead> <tr> <th data-bbox="327 411 472 448">Frequency</th> <th data-bbox="483 411 1115 448">Unit of Measure</th> <th data-bbox="1126 411 1420 448">Sampling Method</th> </tr> </thead> <tbody> <tr> <td data-bbox="327 456 472 493">Continuous</td> <td data-bbox="483 456 1115 493">megalitres per day</td> <td data-bbox="1126 456 1420 493">In line instrumentation</td> </tr> </tbody> </table>	Frequency	Unit of Measure	Sampling Method	Continuous	megalitres per day	In line instrumentation	
Frequency	Unit of Measure	Sampling Method						
Continuous	megalitres per day	In line instrumentation						
M9.1	<b>HRSTS Monitoring</b> The licensee must continuously operate and maintain communication equipment which makes the conductivity and flow measurements, taken at Point 4 available to the "Service provider" within one hour of those measurements being taken and makes them available in the format specified in the "Hunter River Salinity Trading Scheme Discharge Point Site Equipment" as published by the Department of Land and Water Conservation on 7 May 2002.	<b>Section 6.1.9</b>						
M9.2	The licensee must ensure that all monitoring data is within a margin of error of 5% for conductivity measurements and 10% for discharge flow measurement.							
M9.3	The licensee must mark monitoring point(s) number 4, with a sign which clearly indicates the name of the licensee, whether the monitoring point is up or down stream of the discharge point(s) and that it is a monitoring point for the Hunter River Salinity Trading Scheme.							
R1.1	<b>Annual return documents</b> The licensee must complete and supply to the EPA an Annual Return in the approved form comprising: <ol style="list-style-type: none"> <li>1. a Statement of Compliance;</li> <li>2. a Monitoring and Complaints Summary;</li> <li>3. a Statement of Compliance - Licence Conditions;</li> <li>4. a Statement of Compliance - Load Based Fee;</li> <li>5. a Statement of Compliance - Requirement to Prepare Pollution Incident Response Management Plan;</li> <li>6. a Statement of Compliance - Requirement to Publish Pollution Monitoring Data; and</li> <li>7. a Statement of Compliance - Environmental Management Systems and Practices.</li> </ol> At the end of each reporting period, the EPA will provide to the licensee a copy of the form that must be completed and returned to the EPA.	<b>Section 9.2.2</b>						
R1.2	An Annual Return must be prepared in respect of each reporting period, except as provided below.							
R1.5	The Annual Return for the reporting period must be supplied to the EPA via eConnect EPA or by registered post not later than 60 days after the end of each reporting period or in the case of a transferring licence not later than 60 days after the date the transfer was granted (the 'due date').							



EPL 529 Condition	Requirements	Section
R1.6	The licensee must retain a copy of the Annual Return supplied to the EPA for a period of at least 4 years after the Annual Return was due to be supplied to the EPA.	
R1.7	Within the Annual Return, the Statements of Compliance must be certified and the Monitoring and Complaints Summary must be signed by: a) the licence holder; or b) by a person approved in writing by the EPA to sign on behalf of the licence holder.	
R2.1	<b>Notification of environmental harm</b> Notifications must be made by telephoning the Environment Line service on 131 555.	<b>Section 9.2.4</b>
R2.2	The licensee must provide written details of the notification to the EPA within 7 days of the date on which the incident occurred.  Note: The licensee or its employees must notify all relevant authorities of incidents causing or threatening material harm to the environment immediately after the person becomes aware of the incident in accordance with the requirements of Part 5.7 of the Act.	<b>Section 9.2.4</b>
R3.1	<b>Written Report</b> Where an authorised officer of the EPA suspects on reasonable grounds that: a) where this licence applies to premises, an event has occurred at the premises; or b) where this licence applies to vehicles or mobile plant, an event has occurred in connection with the carrying out of the activities authorised by this licence, and the event has caused, is causing or is likely to cause material harm to the environment (whether the harm occurs on or off premises to which the licence applies), the authorised officer may request a written report of the event.	<b>Section 9.2.4</b>
R3.2	The licensee must make all reasonable inquiries in relation to the event and supply the report to the EPA within such time as may be specified in the request.	<b>Noted</b>
R3.3	The request may require a report which includes any or all of the following information: a) the cause, time and duration of the event; b) the type, volume and concentration of every pollutant discharged as a result of the event; c) the name, address and business hours telephone number of employees or agents of the licensee, or a specified class of them, who witnessed the event; d) the name, address and business hours telephone number of every other person (of whom the licensee is aware) who witnessed the event, unless the licensee has been unable to obtain that information after making reasonable effort; e) action taken by the licensee in relation to the event, including any follow-up contact with any complainants; f) details of any measure taken or proposed to be taken to prevent or mitigate against a recurrence of such an event; and g) any other relevant matters.	<b>Section 9.2.4</b>
R3.4	The EPA may make a written request for further details in relation to any of the above matters if it is not satisfied with the report provided by the licensee. The licensee must provide such further details to the EPA within the time specified in the request.	<b>Noted</b>
R4.1	<b>HRSTS Reporting</b> The licensee must compile a written report of the activities under the Scheme for each scheme year. The scheme year shall run from 1 July to 30 June each year. The written report must be submitted to the EPA's regional office within 60 days after the end of each scheme year and be in a form and manner approved by the EPA. The information will be used by the EPA to compile an annual scheme report."	<b>Section 9.2.3</b>

EPL 529 Condition	Requirements	Section
R4.3	The sewage treatment system maintenance program required by Condition O2.6 must be submitted annually to the EPA with the Annual Return.	<b>Section 9.2.2</b>
R4.4	The licensee must retain a copy of each report required by Condition O2.5 for 3 years from the date each report is made.	<b>Noted</b>

## **APPENDIX D: North Wambo Creek Diversion Management Plan**



**WAMBO COAL  
NORTH WAMBO CREEK DIVERSION MANAGEMENT PLAN**

Document No. WA-ENV-MNP-509.6  
July 2020

## Document Control

<b>Document No.</b>	WA-ENV-MNP-509.6
<b>Title</b>	North Wambo Creek Diversion Management Plan
<b>General Description</b>	Management Plan for the North Wambo Creek Diversion
<b>Document Owner</b>	Environment & Community Manager

## Revisions

Rev No	Date	Description	By	Checked	Signature
0	Sept 2007	Original Plan – developed for the construction of the North Wambo Creek diversion	WCPL		
1	April 2019	New plan for the ongoing management of the North Wambo Creek diversion	WCPL	ND	
2	July 2020	Incorporating feedback from Stakeholder consultation, DA305-7-2003 MOD 16 changes and updated remediation schedule	WCPL	ND	

**CONTENTS**

**1.0 COMMITMENT AND POLICY .....5**

1.1 BACKGROUND .....5

1.2 OBJECTIVES AND SCOPE OF THIS PLAN .....6

1.3 NWCD BACKGROUND INFORMATION .....6

1.4 REQUIREMENTS OF THIS PLAN .....7

1.5 STAKEHOLDER CONSULTATION .....8

**2.0 PLANNING .....10**

2.1 ENVIRONMENT BASELINE .....10

2.2 PREDICTED IMPACTS FROM UNDERGROUND MINING .....18

2.3 BASEFLOW SEPARATION .....18

**3.0 IMPLEMENTATION.....22**

3.1 CONSTRUCTION OF THE NORTH WAMBO CREEK DIVERSION .....22

3.2 REHABILITATION OBJECTIVES .....23

3.3 REVEGETATION STRATEGY .....23

3.4 MAINTENANCE AND REHABILITATION (2019 – 2024) .....24

3.5 INTERCEPTED GROUNDWATER .....33

**4.0 MEASUREMENT AND EVALUATION .....34**

4.1 PERFORMANCE AND COMPLETION CRITERIA .....34

4.2 MONITORING PROGRAM .....36

4.3 TRIGGER ACTION RESPONSE PLANS .....42

4.4 NON-COMPLIANCES WITH STATUTORY REQUIREMENTS .....44

4.5 COMPLAINTS .....44

**5.0 REVIEW AND IMPROVEMENT .....45**

5.1 REPORTING .....45

5.2 PLAN REVIEW .....45

**6.0 ACCOUNTABILITIES.....46**

**7.0 ACRONYMS .....47**

**8.0 REFERENCES .....48**

8.1 LEGISLATION .....48

8.2 APPROVALS, MODIFICATION APPLICATIONS AND ASSESSMENTS .....48

8.3 MANAGEMENT PLANS, PROGRAMS AND STRATEGIES .....48

8.4 REPORTS .....49

8.5 OTHER .....50

## Tables

Table 1: DA305-7-2003 Requirements for the NWCD .....	7
Table 2: Independent Audit Findings relevant to the NWCD.....	8
Table 3: Baseline Stream Flow in North Wambo Creek.....	13
Table 4: Flow monitoring stations on the North Wambo Creek.....	13
Table 5: Baseline Water Quality in North Wambo Creek (WCPL, 2003) .....	14
Table 6: Water Quality Results for North Wambo Creek.....	14
Table 7: LFA Results – Landscape Organisation Index .....	16
Table 8: LFA Results – Stability Index.....	16
Table 9: LFA Results – Infiltration .....	16
Table 10: LFA Results – Nutrient Index .....	17
Table 11. Summary of Streamflow Events in North Wambo Creek .....	19
Table 12: Five Year NWCD Rehabilitation and Maintenance Plan .....	26
Table 13: Geomorphological Response to Flood Events – Triggers and Success Criteria .....	34
Table 14: Performance Criteria for the North Wambo Creek Diversion.....	35
Table 15: Colour system devised to highlight the performance of each LFA site .....	35
Table 16: LFA targets for the NWCD.....	36
Table 17: Diversion Monitoring Program .....	37
Table 18: TARP for North Wambo Creek Diversion Performance – Surface Water* .....	42
Table 19: TARP for North Wambo Creek Diversion Performance – Biodiversity*.....	43
Table 20: Subsidence TARP for the North Wambo Creek Diversion .....	44
Table 21: Accountabilities .....	46
Table 22: Acronyms .....	47

## Figures

Figure 1: North Wambo Creek Diversion Location.....	5
Figure 2: Wambo Water Management Plan Structure* .....	5
Figure 3: Location of Alluvium in Lower Reaches of Creeks .....	12
Figure 4: North Wambo Creek Surface Flow Monitoring Locations and Reduction in Catchment Area post Stage 3 Diversion. ....	19
Figure 5: Rainfall versus Stream Flow .....	20
Figure 6: North Wambo Creek - FM1 - Rainfall API versus Stream Stage Relationship.....	21
Figure 7: NWCD 2020-2021 Remediation Works.....	31
Figure 8: NWCD Instability Locations (as of 2019).....	32
Figure 9: Diversion Surface Water Quality and Stream Flow Monitoring Program.....	40
Figure 10: Diversion and Subsidence Monitoring Program – Operational Monitoring.....	41

## LIST OF APPENDICES

<b>Appendix A</b>	NWCD Correspondence
<b>Appendix B</b>	NWCD MP Commitments
<b>Appendix C</b>	Detailed Rehabilitation Plan
<b>Appendix D</b>	NWCD Revegetation Management Plan
<b>Appendix E</b>	North Wambo Creek Subsidence Response Strategy

# 1.0 Commitment and Policy

## 1.1 Background

This North Wambo Creek Diversion Management Plan (this Plan) has been developed for management of the North Wambo Creek Diversion (NWCD) (**Figure 1**). The NWCD is the responsibility of Wambo Coal Pty Ltd (WCPL).

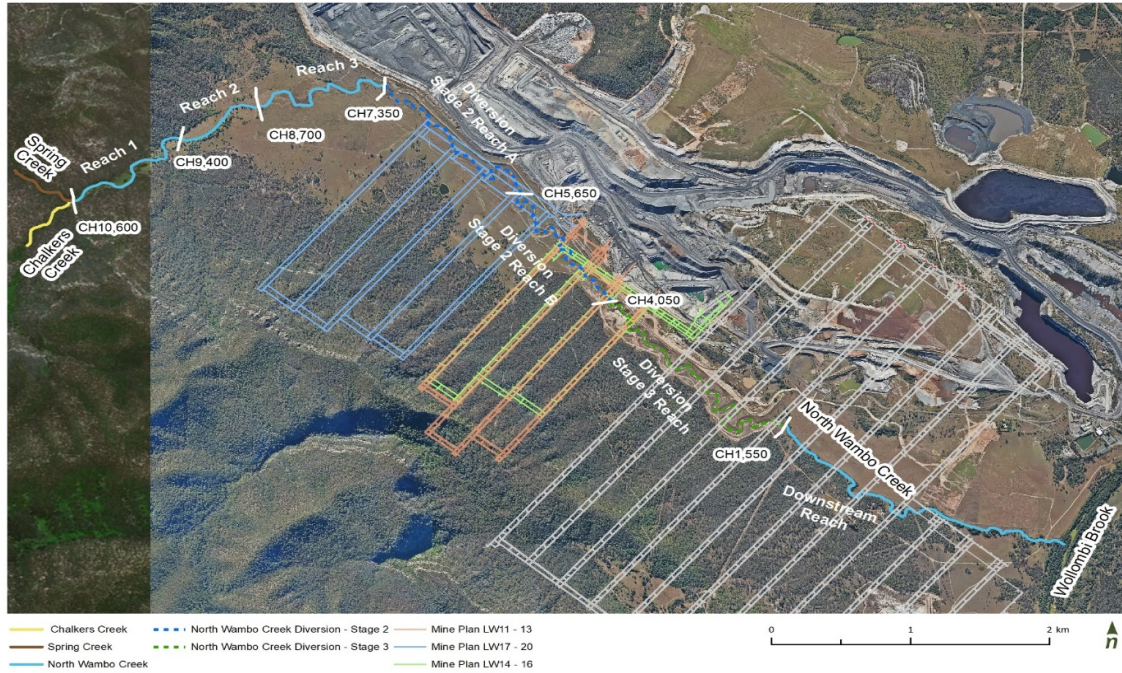

**Figure 1: North Wambo Creek Diversion Location**

This Plan is part of a set of documents that together form the **Water Management Plan (WMP)** for Wambo Coal Mine (Wambo) (refer to **Figure 2**). The WMP is one of a series of Environmental Management Plans that together form the Environmental Management System for Wambo.

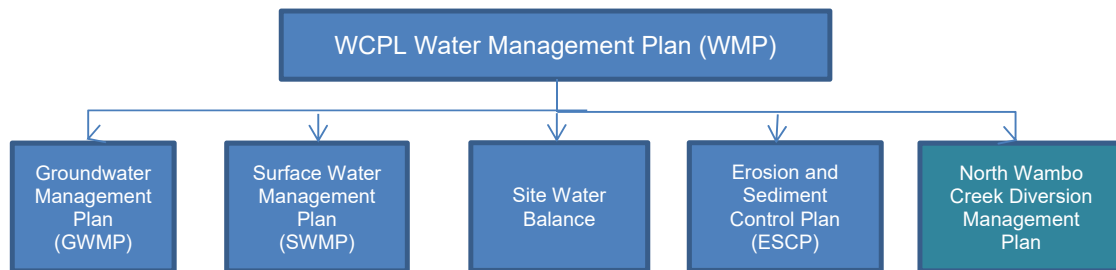

**Figure 2: Wambo Water Management Plan Structure\***

\*This Plan also refers to the WCPL **Surface and Groundwater Response Plan (SGWRP)**, which was required under Schedule 4 Condition 35 of DA305-7-2003 (Mod 17). As the SGWRP is no longer required under DA305-7-2003 (Mod 16, approved on 29 August 2019), relevant information from the SGWRP, including Trigger Action Response Plans for the NWCD, has been incorporated into this version of the Plan.



Other Wambo documents relevant to this Plan are the WCPL **Biodiversity Management Plan** (BMP), WCPL **Environmental Management Strategy** (EMS) and WCPL **Mining Operations Plan** (MOP).

Operations at Wambo currently consist of underground and open cut mining operations, as described in DA305-7-2003 (Mod 16) (Phase 1). Under Phase 2 operations, due to commence in late 2020, underground mining will continue at Wambo however the Wambo open cut will be managed by the adjacent United Wambo Open Cut Project. The responsibility for ongoing monitoring and management of the North Wambo Creek Diversion (NWCD) will remain with WCPL.

Mining operations at Wambo (during both Phase 1 and 2) include the integrated use of the Wambo coal handling and preparation plant, coal stockpiles and rail load-out facility.

## 1.2 Objectives and Scope of this Plan

The objectives of this Plan are to satisfy regulatory requirements and commitments for the rehabilitation and ongoing management of the North Wambo Creek Diversion (NWCD) (**Figure 1**). This plan has been developed to address the requirements of the Development Consent (DA305-7-2003).

This Plan replaces the original NWCD Plan, which was developed in 2007 for the construction of the NWCD. The original NWCD Plan was approved on 14 April 2008 by the then NSW Department of Planning (DoP), now the NSW Department of Planning Industry and Environment (DPIE).

It is noted that the most recent modification of the Development Consent (Modification 16, approved 29 August 2019) no longer requires a specific management plan for the NWCD.

This Plan does not address groundwater monitoring or management within the North Wambo Creek Diversion area. Groundwater monitoring and management for the Wambo mine site is addressed in the WCPL GWMP.

## 1.3 NWCD Background Information

The objective of the NWCD was to divert flows in the North Wambo Creek around the western limit of the open cut operations. The NWCD, as described in the *Wambo Development Project Environmental Impact Statement* (Project EIS) (WCPL, 2003) was originally planned to be constructed in two stages. These stages included:

- Stage 1 – Permanent diversion from the most Northern upper reaches of the creek to immediately upstream of the Wollemi Underground
- Stage 2 – Extension of the Stage 1 Diversion to connect to the existing North Wambo Creek channel downstream of the Wollemi Underground Mine Boxcut.

In 2006 DA305-7-2003 was modified to allow for the construction of a temporary creek diversion of the North Wambo creek in the North Western area (Mod 5). This temporary diversion became Stage 1, with the permanent Stage 1 and 2 diversions becoming Stages 2 and 3 respectively (Resource Strategies, 2006).

## 1.4 Requirements of this Plan

### 1.4.1 Statutory Requirements

#### 1.4.1.1 Development Consent

Wambo received development consent for Development Application DA305-7-2003 in accordance with the *Environmental Planning & Assessment Act 1979* (EP&A Act) from DP&EDPIE on 4 February 2004.

Two modifications to DA 305-7-2003 have been approved to allow for the staged construction of the NWCD (Mod 5 in 2006 and Mod 6 in 2007). Copies of the modification applications, environmental assessment reports and determinations are available on the Wambo website (<https://www.peabodyenergy.com/Operations/Australia-Mining/New-South-Wales-Mining/Wambo-Approvals,-Plans-Reports>).

DA305-7-2003 has been modified ten nine times since Mod 6 was approved in 2007, with the most recent being Mod 16 which was approved in August 2019. Conditions within DA305-7-2003 (as modified) relevant to the NWCD are summarised in **Table 1**.

**Table 1: DA305-7-2003 Requirements for the NWCD**

Schedule	Condition	DA 305-7-2003 (MOD16, August 2019)	Where addressed in this Plan
2	B66	(a) Include a: ... <b>Surface Water Management Plan</b> that includes:	
		<ul style="list-style-type: none"> <li>• detailed plans, design objectives and performance criteria for water infrastructure including:               <ul style="list-style-type: none"> <li>○ any approved creek diversions or restoration works associated with the development;</li> </ul> </li> </ul>	<b>Sections 3.1, 3.2, and 3.4</b>

#### 1.4.1.2 Additional Regulator Requirements

On 14 April 2008, the NWCD Plan was approved by the DPIE (formerly the DoP).

On 1 July 2013 DPIE approved open cut mining of the original creek line, in accordance with specific conditions of DA305-7-2003, subject to the implementation of the approved Remediation and Monitoring Program for Stage 3 of the NWCD (refer **Section 3.4**). In addition to the Development Consent requirements, regulatory authorities have provided additional requirements to be addressed within this plan. These additional requirements and where they have been addressed in this document are detailed in **Appendix A**.

#### 1.4.1.3 Independent Environmental Audits

Further to the Development Consent requirements, Independent Environmental Audits undertaken in 2014 and 2017 have also identified actions required to be undertaken for the NWCD. **Table 2** summarises the findings from these audits and shows where they are addressed in this Plan. In regard to the 2017 IEA finding regarding the development of a stand-alone management plan for the NWCD, this revision of the Plan has sought to include information from other WCPL management plans to address this requirement.

**Table 2: Independent Audit Findings relevant to the NWCD**

Audit	Description	Where addressed in this Plan
2014 IEA	North Wambo Creek Diversion Plan not yet revised to include the required section on mechanism for the return of intercepted groundwater (Schedule 4, Condition 31(c)). <sup>1</sup>	<b>Section 3.5</b>
2017 IEA	The current diversion management and monitoring objectives are contained in several documents. It is recommended these are consolidated into a single management plan for the diversion. It is noted that Wambo is committed to the preparation and implementation of a new Diversion and Rehabilitation Plan.	<b>This Plan</b>
	The diversion management program should be implemented to improve the operation of the diversion.	<b>Sections 3.0 and 4.0</b>
	Ongoing management is required in order to ensure that soil erosion is minimised and ground cover is given adequate opportunity to become established.	<b>Sections 3.4 and 4.0</b>
	Rehabilitation of subsided areas of the diversion is required in accordance with an Extraction Plan (or Subsidence Management Plan), including repairing surface subsidence cracks and undertaking subsidence remediation where necessary in areas where the diversion has been subsided.	<b>Sections 3.0 and 4.0</b>

1. It is noted that this requirement is no longer included in DA305-7-2003 (Mod 16).

#### **1.4.1.4 Environment Protection Licence**

Condition L1.1 of Environment Protection Licence (EPL) 529 requires compliance with Section 120 of the *Protection of the Environment Operations Act 1997*, which prohibits pollution of waters. Management measures outlined in **Section 3.0** of this Plan have been developed to manage the water quality from the site. The EPL is administered by the NSW Environment Protection Authority (EPA).

#### **1.4.2 Commitments**

All commitments outlined within this Plan are detailed in **Appendix B**. Management commitments requiring actioning will be entered into Wambo's compliance management system and actioned. Records of documentation associated with the management commitments will also be maintained by Wambo.

### **1.5 Stakeholder Consultation**

Consultation has been undertaken during a number of phases of the NWCD, from the original environmental assessment for the Project EIS (WCPL, 2003) to the ongoing management and remediation of the NWCD. Consultation continues to be undertaken with key stakeholders as part of WCPL's site reporting and auditing commitments, including for the Annual Review and Independent Environmental Audit (IEA).

The original NWCD Plan was developed in consultation with a range of stakeholders including:

- Government agencies - Department of Planning, Infrastructure and Environment (DPIE), Regional NSW Department of Mining, Exploration and Geoscience (MEG) Resources Regulator (RR), Environment Protection Authority (EPA), Department of Industries Fisheries and DPIE Water Group - Natural Resources Access Regulator (NRAR)
- Specialist consultants - Gilbert and Associates Pty Ltd (Design Report), Alan Watson and Associates Pty Ltd (Design), HLA-Envirosciences (Rehabilitation Plan), Hansen Bailey (SWMP)
- WCPL mine personnel – planners, engineers, managers, safety and environmental staff

A copy of this revised Plan was provided to DPIE, RR, EPA, NSW Fisheries and DPIE Water Group - NRAR for consultation on 20 April 2019. A copy of the regulator comments and how the comments have been addressed is included in **Appendix A** of this Plan.

## 2.0 Planning

### 2.1 Environment Baseline

#### 2.1.1 Landforms and Watercourses

Wambo is located in the Upper Hunter Valley where the landform is characterised by gently sloping floodplains of the Hunter River and its tributaries and the undulating foothills, ridges and escarpments of the Mount Royal Range and Great Dividing Range (Heritage Computing, 2012). Elevations in the vicinity of Wambo range from approximately 60 metres (m) Australian Height Datum (AHD) at Wollombi Brook to approximately 650 m AHD at Mount Wambo within the Wollemi National Park to the west of Wambo.

Watercourses in the vicinity of Wambo Mine include Wollombi Brook, North Wambo Creek, (South) Wambo Creek, Stony Creek, Longford Creek and Doctors Creek. These creeks are tributaries of the Hunter River. The locations of these watercourses are shown in **Figure 3 (Section 2.1.4)**.

North Wambo Creek, which has its headwaters in the Wollemi escarpment, drains the central parts of the mining lease and has a catchment area of 48.5 km<sup>2</sup> (Gilbert and Associates, 2003). A section of North Wambo Creek has been diverted to avoid the Wambo open cut (**Figure 1**). The North Wambo Creek Diversion was constructed in accordance with the approved North Wambo Creek Diversion Plan (WCPL, 2007).

#### 2.1.2 Soils and Rural Land Use Capability

A soils, rural land capability and agricultural suitability assessment was conducted for the Project EIS and utilised information from previous soil surveys, the Department of Land and Water Conservation and NSW Agriculture mapping, aerial photography and field surveys.

Major soil types identified include alluvial soils along major drainage lines, siliceous sands to the east of Wollombi Brook, yellow podzolics and yellow solodic intergrades adjacent to the alluvials on lower slopes and undulating plains, soloths on moderately elevated slopes and lithosols along the eastern boundary of the Wollemi National Park.

A rural land capability assessment was conducted in accordance with the standard NSW eight class system (Cunningham et al., undated) which assesses biophysical soil properties and categorises land according to limitations such as erosion hazard, climate and slope. Seven of the eight classes were identified in the vicinity of the mine.

Further detail on soils and rural land use capability is included in the WCPL BMP.

#### 2.1.3 Climate and Rainfall

The area experiences a dry temperate to sub-tropical climate with hot humid summers and cool drier winters. The annual average rainfall is approximately 650 mm. Further information on rainfall, including a Cumulative Rainfall Departure curve for the area, is included in the WCPL GWMP.

#### 2.1.4 Geology

Wambo is located in the Hunter Coalfield, which occupies the north-eastern portion of the Sydney Basin. The site is underlain by the Permian Singleton Coal Measures as well as Quaternary alluvial sediments along watercourses. This is underlain by the Permian Maitland Group which consists of siltstone, sandstone and conglomerate.

Approximate boundaries of quaternary alluvial sediments in the vicinity of Wambo are shown in **Figure 3** and have been derived from the Hunter Coalfields Regional Geology 1:100,000 map (NSW Department of Mineral Resources, Edition 2 1993).

A transient electromagnetic survey (Groundwater Imaging, 2012) was carried out to investigate the extent and thickness of alluvium along the lower reaches of (South) Wambo and North Wambo Creek. The extent of alluvial sediments determined from that study is also presented on **Figure 3**.

Further information on the geology of the area is included in the WCPL GWMP.

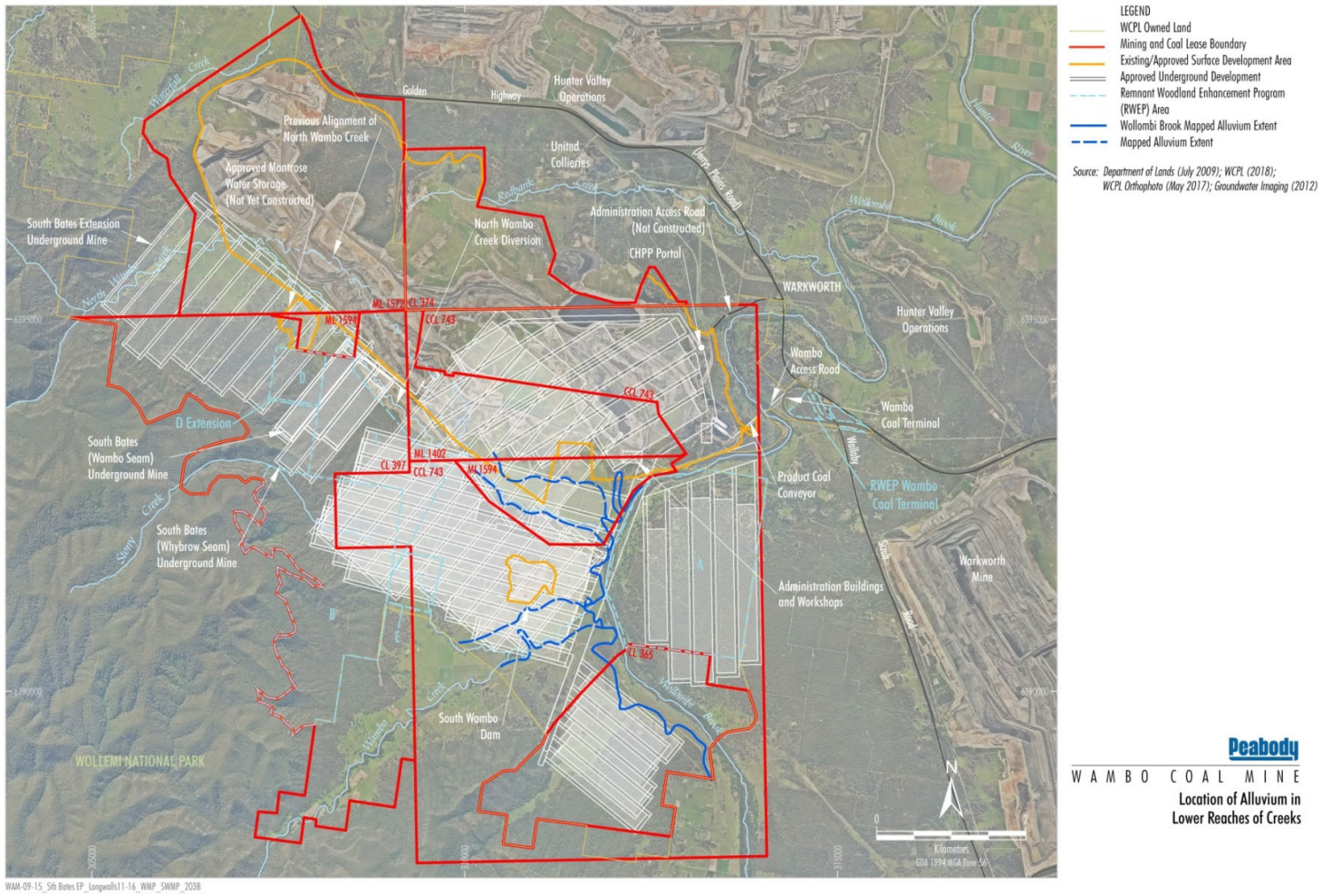

Figure 3: Location of Alluvium in Lower Reaches of Creeks

### 2.1.5 Stream Flow

North Wambo Creek is an intermittent stream which ceases to flow in extended dry periods.

Three V-notch weirs were established by United Collieries (United) in 2001/2002 to record flow along North Wambo Creek. A summary of flow records from United weir sites 1 and 2, for the period 14 June 2002 to 1 October 2003, is included in the WCPL SWMP and reproduced in **Table 3**.

**Table 3: Baseline Stream Flow in North Wambo Creek**

Site	Flow Days	Max (L/s Day)	Min (L/s)	Mean (L/s)
Weir 1	NA	9.3	0.0	1.5
Weir 2	NA	120.0	0.0	0.9

Flow monitoring data collected at Weir 3 for the period December 2001 to December 2004 generally showed the creek to be dry, except following significant rainfall. The highest flow recorded at Weir 3 during the data period was 0.1 L/sec in late May 2002 (Geoterra, 2005).

In addition to the baseline data collected in the North Wambo Creek during 2001-2003, WCPL has also established a number of flow monitoring stations along the North Wambo Creek, including within the NWCD to monitor stream flow. Five flow monitoring stations were established in the North Wambo Creek between 2008 and 2017. Flow monitoring locations are shown on **Figure 9** (in **Section 4.2**). The maximum flow recorded at these five stations during the period of record is provided in **Table 4**.

**Table 4: Flow monitoring stations on the North Wambo Creek**

Site	Location	Period of Record <sup>^</sup>	Max flow recorded (ML/Day)
US FM1	North Wambo Creek (Upper)	Dec 2017 – present	282
FM1	North Wambo Creek	Oct 2008 – present	264.81
FM2	Mid way along the North Wambo Creek diversion	Apr 2009 – present	160
FM3	Mid way along the new diversion of the North Wambo Creek	Feb 2015 – present	140
FM4	North Wambo Creek (Upstream of the confluence of North Wambo Creek and Wollombi Brook)	Oct 2008 – present	14,300*

<sup>^</sup> The period of record may not be a continuous period of record – there may be periods where no flow data was captured (refer to SWMP for further detail on data capture percentages).

\* A flow event at FM4 in April 2015 was influenced by backwater flooding from Wollombi Brook. The next largest flow day during the period of record was 291.28 ML (between 1 Feb 2014 and 19 Aug 2014).

Further information on historical flow monitoring and the monitoring data from these stations is included in the WCPL SWMP.

### 2.1.6 Water Quality

WCPL has been monitoring water quality, including pH, electrical conductivity (EC), total suspended solids (TSS) and total dissolved solids (TDS), in the North Wambo Creek since 1994 (WCPL, 2003). Baseline water quality of North Wambo Creek is described in the Project EIS (WCPL, 2003) and reproduced in **Table 5**.

Monitoring sites SW04 and SW05 are shown on **Figure 9** (in **Section 4.2**). Sites SW26 and SW27 were located within the original North Wambo Creek, which has since been mined through. Further information on the baseline monitoring program is included in the Surface Water Assessment for the Project EIS (Gilbert and Associates, 2003).



**Table 5: Baseline Water Quality in North Wambo Creek (WCPL, 2003)**

	SW04 – Upstream	SW05 - Downstream	SW26	SW27
Sampling Period	July 1996 – Sept 2002	Jan 1994 – Sept 2002	June – Sept 2002	June - Sept 2002
<b>pH</b>				
min	7.1	6.6	6.4	7.0
max	8.0	8.9	7.2	8.4
mean	7.6	7.7	6.9	7.9
<b>EC (µS/cm)</b>				
min	291	240	639	970
max	410	4,650	687	1,056
mean	351	1,839	663	1,027
<b>TDS (mg/L)</b>				
min	184	114	360	524
max	236	4,460	366	582
mean	210	1,135	362	548
<b>TSS (mg/L)</b>				
min	NR	1	1	1
max	NR	71	8	2
mean	NR	6	4	2

\* NR = no results available

WCPL has continued to monitor water quality at sites SW04 and SW05 since 2003. New water quality monitoring sites were established in the North Wambo Creek in 2012, to monitor water quality within the NWCD. These sites include SW27a, in the middle lower section of North Wambo Creek, and SW32a at the North Wambo Creek pump site (refer **Figure 9** in **Section 4.2**). Water quality data collected since 2003 is included in **Table 6**.

**Table 6: Water Quality Results for North Wambo Creek**

	SW04 – North Wambo Creek Up	SW05 – North Wambo Creek Down	SW27a – North Wambo Creek Middle Lower	SW32a – North Wambo Creek Pump
No of samples	4	137	46	39
Sampling period	July 2003 – Jan 2018	July 2003 – Jan 2018	2012 – Jan 2018	2012 – Jan 2018
<b>pH</b>				
min	7.3	6.94	7.00	7.30
max	8.71	8.96	9.00	9.20
mean	8.03	7.66	7.93	8.05
<b>EC (µS/cm)</b>				
min	256	111	52	199
max	563	3,200	3,360	6,970
mean	362	1,698	927	861
<b>TDS (mg/L)</b>				
min	157	135	184	153
max	2,712	3,642	4,900	4,400
mean	855	1,021	954	779
<b>TSS (mg/L)</b>				
min	5	1	1	1
max	154	1,110	5,440	4,190
mean	47	52	477	435

The data in the above table has been used to develop performance criteria for water quality in the North Wambo Creek. This performance criteria is included in **Section 4.1.2**. A Trigger Action Response Plan (TARP) has also been developed for implementation if monitoring data indicates that the water quality performance criteria have not been met. This TARP is included in **Section 4.3**.

## **2.1.7 Biodiversity**

Baseline biodiversity surveys were undertaken for the Project EIS (WCPL, 2003). Further surveys have been undertaken as part of subsequent mine modifications, including the South Wambo, South Bates and South Bates Extension Underground Mines. The findings of these surveys are included in the WCPL BMP with a summary of the information included below.

The results of annual biodiversity monitoring undertaken along the NWCD (refer **Section 4.2**) are compared against baseline surveys.

### **2.1.7.1 Flora**

Flora surveys of the Mine site were undertaken in 2003 by Orchid Research as part of the Project EIS (WCPL, 2003). Follow up surveys were completed as part of the South Wambo Underground, South Bates Underground and South Bates Extension Underground (FloraSearch, 2015, 2016 and 2017).

A total of 17 vegetation communities have been identified in the Wambo Mine study area, including a number of threatened Endangered Ecological Communities. A number of threatened flora species and populations have also been recorded (or have potential to occur) onsite including *Acacia pendula* (FloraSearch, 2015).

Further detail on the results of these surveys is included in the WCPL BMP.

### **2.1.7.2 Fauna**

Avifauna, mammals, reptiles and amphibians were surveyed at the Mine by Mount King Ecological Surveys and Greg Richards and Associates in 2003 as part of the Project EIS (WCPL, 2003).

The fauna surveys recorded a relatively large number of woodland birds and birds associated with waterbodies. Threatened fauna species recorded in the vicinity of WCPL include amphibians (3), reptiles (2), birds (41) and mammals (20). Eleven pest fauna species were also recorded in the Project EIS surveys (WCPL, 2003).

### **2.1.7.3 Aquatic Ecosystems**

Aquatic macroinvertebrate, fish and water quality sampling was conducted for the Project EIS (WCPL, 2003).

The sampling found North Wambo Creek to represent minimal fish habitat with two native and one introduced fish species recorded from North Wambo Creek during the sampling (WCPL, 2003).

## **2.1.8 Landscape Function Analysis**

Landscape Function Analysis (LFA) is a monitoring procedure developed by the Commonwealth Scientific and Industrial Research Organisation (CSIRO) (Tongway and Hingley, 2004). It provides a rapid, reliable and easily applied method for assessing and monitoring landscape restoration or rehabilitation. It uses simple indicators that assess how well a landscape works as a system.

LFA monitoring plots were established in riparian rehabilitation areas along the North Wambo Creek in 2008. Additional plots were added in 2015 in the North Wambo Creek Diversion and Wambo Creek. LFA Monitoring locations are shown on **Figure 10** (in **Section 4.2**).

Plots are monitored on an annual basis in accordance with the methodology and monitoring program described in the WCPL BMP. Baseline LFA results for the NWCD and Wambo Creek (for reference) are provided in **Table 7** to **Table 10**. Monitoring results from the last nine years of monitoring for the NWCD and Wambo Creek have also been included in these tables.

**Table 7: LFA Results – Landscape Organisation Index**

Site	2008	2009	2010	2011	2012	2013	2014	2015	2016	2017
<b>NWCD</b>										
17R	-	1	1	1	0.86	0.92	0.97	0.93	0.96	0.92
19R	0.25	1	1	1	1	1	0.69	0.71	0.75	0.71
21R	0.18	1	0.81	1	0.86	1.07	0.54	0.66	0.76	0.87
23R	-	0.6	0.63	0.85	0.84	0.84	0.7	0.41	0.44	0.34
25R*	-	-	-	-	-	-	-	0.45	0.59	0.74
26R*	-	-	-	-	-	-	-	0.55	0.67	0.72
27R*	-	-	-	-	-	-	-	0.35	0.35	0.29
28R*	-	-	-	-	-	-	-	0.43	0.55	0.41
<b>Average</b>	<b>0.22</b>	<b>0.90</b>	<b>0.86</b>	<b>0.96</b>	<b>0.89</b>	<b>0.96</b>	<b>0.73</b>	<b>0.56</b>	<b>0.63</b>	<b>0.63</b>
<b>Wambo Creek</b>										
14R*	-	-	-	-	-	-	-	0.67	-	0.99

\* New riparian monitoring site added in 2015  
 - No data available

**Table 8: LFA Results – Stability Index**

Site	2008	2009	2010	2011	2012	2013	2014	2015	2016	2017
<b>NWCD</b>										
17R	-	79	70	71.3	56.1	74.5	64	60.1	65.1	62.2
19R	53	71	61	65.6	57	54.3	55.1	53.8	55.9	64.6
21R	56	75	62	65.4	58.6	65.8	53.4	56.5	60.3	60.5
23R	53	52	48	52.6	44.9	45.9	50	51.4	56.8	44.1
25R*	-	-	-	-	-	-	-	52.1	56.9	58.6
26R*	-	-	-	-	-	-	-	54.2	59	61.1
27R*	-	-	-	-	-	-	-	52.1	58.1	46.7
28R*	-	-	-	-	-	-	-	45.9	51.9	52.2
<b>Average</b>	<b>54</b>	<b>69.25</b>	<b>60.25</b>	<b>63.725</b>	<b>54.15</b>	<b>60.125</b>	<b>55.625</b>	<b>53.26</b>	<b>58</b>	<b>56.25</b>
<b>Wambo Creek</b>										
14R*	-	-	-	-	-	-	-	52.3	-	53.9

\* New riparian monitoring site added in 2015  
 - No data available

**Table 9: LFA Results – Infiltration**

Site	2008	2009	2010	2011	2012	2013	2014	2015	2016	2017
<b>NWCD</b>										
17R	-	37	36	41.2	27.7	38.4	38.4	37.6	36.3	38.6
19R	27	42	33	30.7	25.1	19.6	23.1	27.7	32.6	30
21R	33	47	23	33.2	30	28.4	24.2	33.7	34.8	35
23R	30	27	26	29	18.4	23.3	25.7	30.1	27.4	28.6
25R*	-	-	-	-	-	-	-	23.9	29.9	31.9
26R*	-	-	-	-	-	-	-	28.1	30.2	27.9
27R*	-	-	-	-	-	-	-	22.9	24.8	33.5
28R*	-	-	-	-	-	-	-	26.1	25.5	38.2
<b>Average</b>	<b>30.00</b>	<b>38.25</b>	<b>29.50</b>	<b>33.53</b>	<b>25.30</b>	<b>27.43</b>	<b>27.85</b>	<b>28.76</b>	<b>30.18</b>	<b>32.96</b>
<b>Wambo Creek</b>										
14R*	-	-	-	-	-	-	-	45.0	-	40.3

\* New riparian monitoring site added in 2015  
 - No data available

Table 10: LFA Results – Nutrient Index

Site	2008	2009	2010	2011	2012	2013	2014	2015	2016	2017
<b>NWCD</b>										
17R	-	39	30	40.1	28.2	34.6	30.2	28.3	26.8	33.3
19R	15	38	30	30.8	25.1	15.2	18.4	20	21.9	26.7
21R	17	44	21	30.5	29.7	26.1	19.5	24.6	25	31.1
23R	14	18	19	24.5	15.4	15.6	17.4	17.2	14.6	19.5
25R*	-	-	-	-	-	-	-	16.2	20	26.2
26R*	-	-	-	-	-	-	-	18.5	24.7	25.6
27R*	-	-	-	-	-	-	-	13.9	15.2	19.6
28R*	-	-	-	-	-	-	-	16	19.2	26.4
<b>Average</b>	<b>11.5</b>	<b>27.8</b>	<b>20</b>	<b>25.18</b>	<b>19.68</b>	<b>18.3</b>	<b>17.1</b>	<b>19.34</b>	<b>20.93</b>	<b>26.05</b>
<b>Wambo Creek</b>										
14R*	-	-	-	-	-	-	-	29.6	-	29.5

\* New riparian monitoring site added in 2015

- No data available

The data in the tables above has been used to develop target scores for LFA for the NWCD. These target scores are included in **Section 4.1.3**. A TARP has also been developed for implementation if monitoring data indicates that there is less than 5% annual improvement or a decline in the LFA target score (from the previous monitoring round). This TARP is included in **Section 4.3**.

## 2.1.9 Geomorphology

### 2.1.9.1 2006 Geomorphic Assessment

The form and status of North Wambo Creek was assessed by Gilbert and Associates during a detailed site reconnaissance and mapping programme which was conducted in March 2006 and by supplementary observations in February 2007. The assessment resulted in the production of a series of strip maps showing the main geomorphological features and a suite of photographs which provided further visual record of the creek. The reconnaissance was conducted from a point approximately 800 m upstream of the proposed diversion inlet to the confluence of North Wambo Creek with Wollombi Brook. A summary of the geomorphological conditions of North Wambo Creek in the reach that would be replaced by the diversion was provided in the *North Wambo Creek Diversion Design Report* (Gilbert and Associates, 2007).

Geomorphological triggers and success criteria were developed as part of the detailed design of the NWCD. These triggers and success criteria are described in **Section 4.1.1**. A review of these triggers and success criteria will be undertaken by WCPL in 2020/2021.

### 2.1.9.2 2018 Geomorphic Context Statement

In accordance with Schedule 4, Condition 33A of DA 305-7-2003 (Modification 17), WCPL commissioned Alluvium Consulting Australia (Alluvium) to undertake a pre-subsidence (baseline) survey, energy profile analysis and geomorphic context statement on North Wambo Creek (the North Wambo Creek Baseline Report). The study was completed in February 2018, on a natural section of North Wambo Creek, directly above future Longwalls 23, 24 and 25 (South Bates Extension Mine) and upstream of this area.

The reaches of North Wambo Creek and its upstream tributaries of Spring and Chalkers Creek were categorised in accordance with the River Styles Framework. Energy conditions in each of the reaches were assessed to inform the broader assessment and likely future trajectory of the geomorphic character, behaviour and condition of the waterway. The results of this assessment will be considered during the review of performance criteria for the NWCD and development of future Extraction Plans for the South Bates Underground Extension Mine. A

copy of the North Wambo Creek Baseline Report (Alluvium, 2018) was provided to DPIE Water Group - NRAR and DPIE on 10 April and 1 May 2018 respectively.

## 2.2 Predicted Impacts from Underground Mining

The Project EIS included predictions relating to underground mining subsidence for the North Wambo Creek. These predictions included the creation of a subsidence-induced basin in the lower sections of the North Wambo Creek (WCPL, 2003). It was expected that this basin would form a wetland over time, acting as a trap for many of the sediments moving through the diversion with beneficial effects in terms of water quality entering Wollombi Brook.

Predicted subsidence impacts on surface water, including the NWCD, have been assessed as part of the environmental assessments for the South Wambo, South Bates and South Bates Extension Underground Mines. The extraction plans developed for longwall extraction in these mines detail the predicted impacts and proposed management and mitigation measures to be implemented.

Approximately 980 metres (m) of the NWCD has been undermined by Longwalls (LW) 11 to 13 and LW 14 to 16 at the South Bates Underground Mine. An additional 30 m will be undermined by LW 17 in the South Bates Underground Extension Mine. Subsidence impacts on the NWCD as a result of the extraction of LW 17 are expected to be similar to those observed in the adjacent South Bates Underground Mine. The potential environmental consequences to the NWCD described in the South Bates Extension Modification EA (WCPL, 2017) include:

- potential for minor increased ponding above LW 17;
- potential for surface cracking above LW 17 (similar to that observed above LW 11) and minor cracking along the section of the Diversion not located directly above the longwalls;
- potential for increased scour (and associated suspended solids) prior to the implementation of scour protection works; and
- potential for increased leakage from the Diversion prior to crack remediation works.

Management and mitigation measures have been developed to address the predicted subsidence impacts on the NWCD. These measures are described in detail in the relevant extraction plans and are summarised in the **North Wambo Creek Subsidence Response Strategy (NWCSRS)**. A copy of the NWCSRS is included in this Plan (**Appendix E**).

## 2.3 Baseflow separation

An assessment of surface water baseflow separation has been undertaken for stream flow gauges in North Wambo Creek. This work was completed in 2019 and early 2020 to address comments made by DPIE Water and the Natural Resources Access Regulator (NRAR) on this Plan (Version 1).

North Wambo Creek is an ephemeral stream and only flows after significant rainfall events. Its headwaters are located in the Wollemi escarpment which include sandstone escarpments that have very high infiltration losses to the aquifer. The creek drains the central parts of the Wambo Coal mining lease. Extension of the Wambo Open-Cut Mine required a diversion of the creek.

As the open cut mine extended towards the diversion, the pit encroached on the alluvial aquifer. Recent and historic subsidence has contributed to reduced surface flows occurring in the creek.

A number of reports and data files were provided to Alluvium for this assessment. This included annual flow monitoring reports and this Plan. In addition, surface flow monitoring data was provided in spreadsheets for flow stations along the North Wambo Creek and within the diversion. Five flow monitoring stations were established between 2008 and 2017 (refer **Table 4**). The location of each flow monitoring location is shown in **Figure 4**.



**Figure 4: North Wambo Creek Surface Flow Monitoring Locations and Reduction in Catchment Area post Stage 3 Diversion.**

The flow data for the period spanning 2012 to 2020 was inspected for suitable flow events. The majority of records have either no flow due to dry conditions or very low flow (less than 0.1 m<sup>3</sup>/s) which is too small for meaningful analysis. There are also gaps in the record due to instrumentation issues. Five flow events (presented in **Table 11**) were selected for baseflow analysis because they have larger peak flows with relatively smooth hydrographs and represent the best available data.

**Table 11. Summary of Streamflow Events in North Wambo Creek**

Event No	Date	NWC Diversion	Peak flow (m <sup>3</sup> /s)		Cumulative vol. FM1 (m <sup>3</sup> )	Cumulative rainfall (mm)	Flow index (m <sup>3</sup> /mm)	FM1 Baseflow drawdown (days)
			FM1	FM4				
1	Feb-09	Stage 2	1.3	1.9	678,606	212	3,198	5 to 6
2	Apr-09	Stage 2	3.0	2.9	943,649	124	7,641	10 to 15
3	Apr-15	Stage 3	2.3	- *	323,721	170	1,913	5 to 6
4	Jan-16	Stage 3	2.4	10.4	493,324	240	2,055	5 to 6
5	Feb-20	Stage 3	0.7	1.8	21,007	180	117	2 to 3

\* Note:FM4 removed due to influence of flood ingress from Wollombi Brook

A key observation in **Table 11** is that the flow index in Event 5 is considerably lower than the other events. This event came at the end of a hot and very dry summer season. The dryness of the catchment and deficit of groundwater likely resulted in far greater rainfall losses in this event with a corresponding short surface flow.

A comparison of rainfall and surface streamflow data was undertaken to analyse the North Wambo Creek system response to storm events to identify a minimum threshold of rainfall that is required prior to the onset of surface flow (**Figure 5**). Such a relationship will assist with providing performance measures and the performance of the groundwater model.

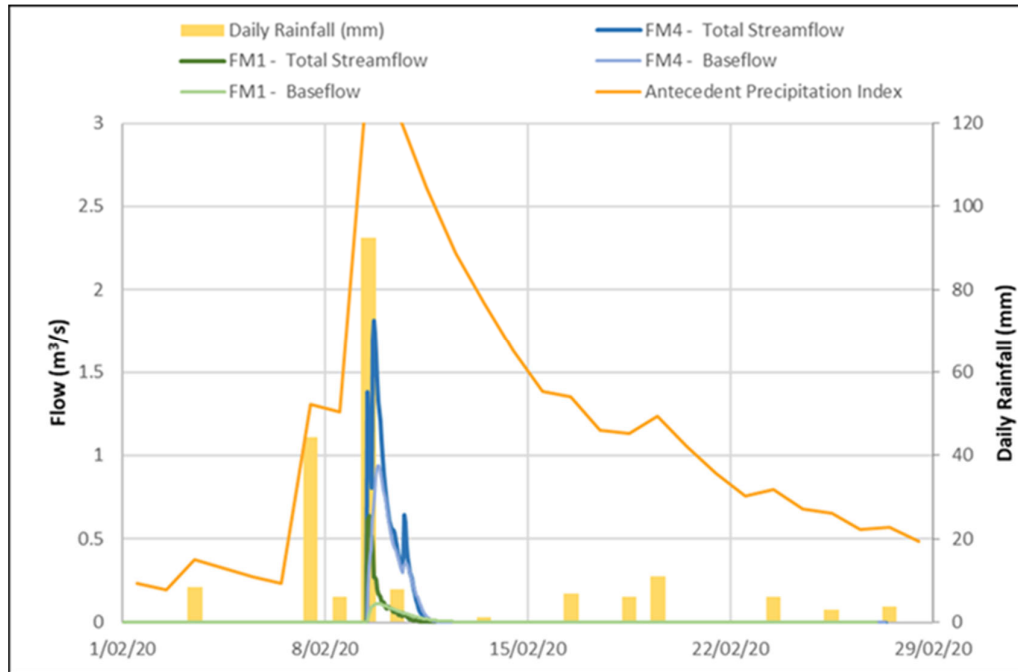

**Figure 5: Rainfall versus Stream Flow**

The adopted approach uses Antecedent Precipitation Index (API) to provide a combined measure of catchment wetness and the total rainfall from the storm event being assessed. A plot of the Stage-API relationship for streamflow station FM1 is presented in **Figure 6**. The points that relate to the onset of streamflow indicate that a minimum API value of 100 mm is required before flow is registered at the gauge. The orange points represent events that most likely resulted in flow, but the data is unreliable. Some of the flow events include successive peaks following additional rainfall and these have also been emphasized.

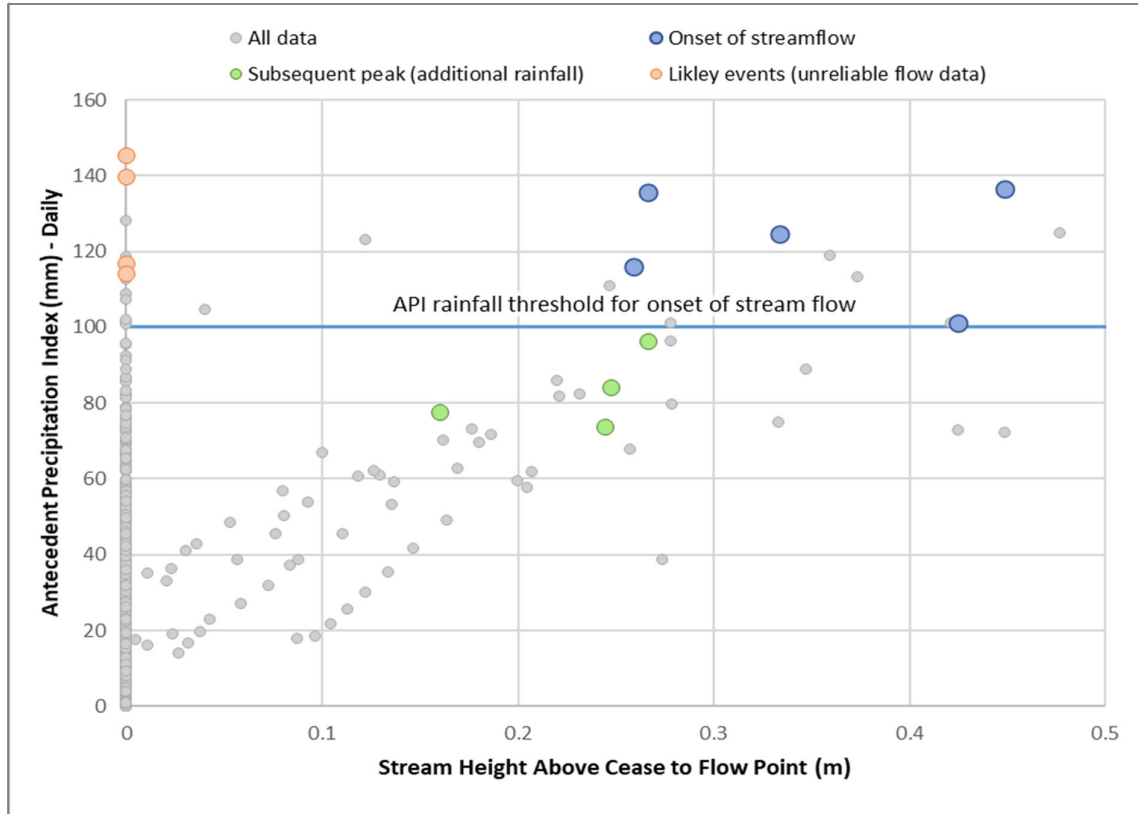

Figure 6: North Wambo Creek - FM1 - Rainfall API versus Stream Stage Relationship

In summary, five flow events have been analysed in an attempt to understand the change in catchment runoff and baseflow in North Wambo Creek pre and post development. This is a small number of events to understand the typical catchment response to rainfall. Ideally a greater number of events would be considered including different times of year (seasonal changes) as the response would change within and between years.

Further information in response to Regulator comments and recommendations is included in **Appendix A**.



## 3.0 Implementation

### 3.1 Construction of the North Wambo Creek Diversion

Construction of the NWCD was undertaken in a staged approach with construction design works undertaken and approved by DPIE prior to the construction of the diversion in 2007.

The objective of the NWCD was to divert flows in the North Wambo Creek around the western limit of the open cut operations. The diversion was to be constructed in two stages:

- Stage 1: Initially the upstream portion of the Diversion would be constructed generally along the alignment shown in the Project EIS and would connect to the existing North Wambo Creek channel upstream of the Wollemi Underground Mine Boxcut; and
- Stage 2: This stage would comprise an extension of the Stage 1 Diversion in a south-easterly direction to connect to the existing North Wambo Creek channel downstream of the Wollemi Underground Mine Boxcut.

Further detail on the staged approach to the NWCD construction is included in the Statement of Environmental Effects for the Wambo Coal Mine Modification (Mod 5) (WCPL, 2006). A further modification application was submitted in 2006 to allow for the construction of a temporary creek diversion on a 2km section of the North Wambo Creek to allow for the construction of the permanent Diversion (Mod 6). Mod 6 was approved on 25 January 2007.

This resulted in a three stage construction program (refer **Section 3.1**).

#### 3.1.1 Diversion Design

Gilbert and Associates Pty Ltd, in conjunction with Allan Watson Associates Pty Ltd, were commissioned by WCPL to design the NWCD. The design process involved geotechnical site investigations; a geomorphological assessment of the North Wambo Creek, detailed survey of the proposed inlet and outlet areas of the diversion; hydrological and hydraulic modelling and a pit inflow risk assessment study. The design was documented in the North Wambo Creek Diversion Design Report (Gilbert and Associates, 2007), which was appended to the original NWCD Plan.

Geomorphological success criteria and triggers were developed by Gilbert and Associates Pty Ltd and included in the North Wambo Creek Diversion Design Report (Gilbert and Associates, 2007). The intention was that these criteria would be used as a regulatory tool to assess performance relative to the design intention of the NWCD and as a set of levels at which corrective actions would be initiated. The success criteria and action triggers proposed in the North Wambo Creek Diversion Design Report are included in **Section 4.1**.

The NWCD design was developed in consultation with relevant stakeholders and was approved by the NSW Department of Planning in 2008, as part of the original NWCD Plan.

#### 3.1.2 Construction Program

A construction program was developed for the NWCD in accordance with Schedule 4, Condition 31 of DA305-7-2003 (Mod 6). The program described how the work would be staged and progressively integrated with the mining operations and the mine waste emplacement drainage system. The program was appended to the original NWCD Plan.

The NWCD construction program involved the construction of a flood levee and creek bed which starts at the north-western limit of the Wambo open cut operations and re-joins the North Wambo Creek downstream of the Wollemi Box Cut.

### 3.2 Rehabilitation Objectives

The Wambo MOP defines the rehabilitation domain and objectives for the NWCD.

The rehabilitation objectives for the NWCD include:

- Pasture species established consistent with revegetation strategy.
- Tree species established along creek line consistent with riparian zone.
- Creek diversion stable and will not present a greater safety hazard than surrounding land.
- Creek diversion able to shed water safely without causing excessive erosion, jeopardising landform integrity or increasing pollution of downstream watercourses.
- All watercourses subject to subsidence impacts shall be hydraulically and geomorphologically stable, with riparian vegetation established that is the same or better than prior to commencement of mining.

The rehabilitation objectives have been utilised to inform the performance and completion criteria included in **Section 4.1**.

### 3.3 Revegetation Strategy

The MOP includes a revegetation strategy for the Wambo Mine site. The objectives of the strategy are to increase the amount of native vegetation, particularly in those landscapes that have been extensively cleared. The rehabilitation program will aim to increase the continuity of vegetation in the region through the establishment of woodland corridors, linking the rehabilitation areas with existing remnant vegetation and Wollemi National Park.

Historically, the revegetation strategy for the NWCD sought a net increase in the quantity of riparian vegetation and included the planting of native species such as River Oak (*Casuarina cunninghamiana*) and Rough-barked Apple (*Angophora floribunda*) on creek banks.

Revegetation required for the implementation of the 5 Year Rehabilitation and Maintenance Plan, detailed in **Section 3.4.1**, will be consistent with the *North Wambo Creek Diversion Revegetation Management Plan* (**Appendix D**). The plan states, following soil analysis and investigation that it would be '*.. more appropriate to establish a woodland vegetation type on the majority of the creek diversion site*'. This conclusion is reinforced by the 2019 analysis of flows in the North Wambo Creek system, which concluded around 100 mm of rainfall is required before flow is registered in the NWCD (refer to **Section 2.3**).

Some areas of the diversion remain suitable for the establishment of riparian vegetation, particularly where the creek profile will slow water flow and therefore increase the availability of moisture. These areas will be identified once the final landform is constructed and will be rehabilitated with a species mix which includes both riparian and woodland species.

A net increase in riparian vegetation is no longer considered achievable.

### 3.4 Maintenance and Rehabilitation (2019 – 2024)

The following sections detail the monitoring and rehabilitation works which are required to be undertaken at the NWCD during the period 2019 – 2024. Maintenance and rehabilitation works for the NWCD have previously been included in the 2013 Remediation and Monitoring Program, which was developed by WCPL following a significant storm event in 2013. The 2013 Remediation and Monitoring Program has been incorporated, where relevant, into the 5 Year Rehabilitation and Maintenance Plan and will be superseded by this document (refer to **Section 3.4.1**).

#### 3.4.1 Five Year NWCD Rehabilitation and Maintenance Plan

In 2018 Alluvium were engaged by WCPL to develop a Five Year Rehabilitation and Maintenance Plan for the NWCD for the period 2019 -2024 (5YR RMP) to address ongoing issues relating to bank stability, erosion and revegetation. The 5YR RMP was updated in April 2019 to include a Detailed Rehabilitation Plan with recommended management actions and rehabilitation works for identified issues. A copy of the Detailed Rehabilitation Plan has been included in **Appendix C**.

The works undertaken by Alluvium included an assessment of existing batter chutes, a review of areas of channel and bank instability and a review of areas on site which required ripping, soil amelioration and revegetation works. Alluvium also assessed the requirement for additional batter chutes in the LW15/16 area. The focus of the rehabilitation plan is the area of the NWCD downstream of LW16 as underground mining and related subsidence has not yet occurred in the area upstream of LW16.

Recommended rehabilitation works, as detailed in the Detailed Rehabilitation Plan developed by Alluvium (**Appendix C**), include:

- Re-forming overland flow entry management, both bunds and batter chutes in the downstream portion of the NWCD and the portion over LWs 11-16.
- Ripping, soil amelioration and revegetation establishment on upper surfaces, upper batters and the inset floodplain (as identified by the blue shading in **Figure 7**).
- Bank stability management in areas identified in the extraction plans for LWs 11-16 and LWs 17-20 (as identified by the red shading in **Figure 8**).

The overall objective of the 5YR RMP is to achieve the performance and completion criteria detailed in **Section 4.1**. The 5YR RMP is summarised in **Table 12** and described further in **Section 3.4.1.1**. The locations of all proposed site works and instability are shown on **Figure 7** and **Figure 8**.

All works will be undertaken in accordance with the Detailed Rehabilitation Plan (**Appendix C**), which will be revised as required. Additional monitoring and inspections will be undertaken in accordance with site-specific Erosion and Sediment Control Plans or Surface Disturbance Permit requirements for on-ground works. Ongoing monitoring will continue to be undertaken in accordance with **Section 4.2**. Performance will be reviewed annually against the performance criteria in **Section 4.1** and the 5YR RMP, with results reported in the Annual Review.

The five year rehabilitation strategy has been developed as a staged approach to enable WCPL to:

- Finalise consultation with regulatory authorities in regard to this Plan;
- Enable the revision of the performance and completion criteria (refer to **Section 4.1**) for the NWCD, based on ACARP studies undertaken and the proposed works to be undertaken; and
- Commence planning including detailed design, development of a works program and associated tender documentation for works described in this Plan.

The Five Year Rehabilitation and Maintenance Plan in **Table 12** has been developed as a high level program which aligns with the recommendations in the North Wambo Creek Detailed Rehabilitation Plan (refer to **Appendix C**). The works to be undertaken each year will be confirmed in the Wambo Annual Review (refer to **Section 5.1.1**).

Table 12: Five Year NWCD Rehabilitation and Maintenance Plan

Task <sup>1</sup>	Task Description	2019	2020	2021	2022-2023
	New batter chute construction		New chutes 8, 9, 11 and 12	New chute 10 <sup>2</sup>	<p>Scope of works to be undertaken in Years 2022 – 2023 will be confirmed within the Wambo Annual Review. The scope of works to be undertaken in these years will be determined following of review of this plan based on monitoring results collected annually, and a review of the performance of the newly constructed batter chutes and the completed batter chute repairs.</p> <p>This work will likely include:</p> <ul style="list-style-type: none"> <li>• Areas upstream of LW15/16 area (where subsidence is complete)</li> </ul>
	Existing batter chute repairs		None proposed	3 and 7	
	In-stream Stability Works <sup>6</sup>	-	Two tier bed control, log deflectors, bench reconfiguration	-	
	Stabilisation works		LW15/16 area	Instability areas - sites 01 and 05, including reprofiling of benches	
	Road Realignment works	-	-	Between batter chutes 7 and 9	
Revegetation works	Native grass seed collection across lease area	Complete	Spring	Spring <sup>3</sup>	
	Native pasture trial		Seeding	Review <sup>3</sup>	
	Development of Revegetation Strategy		Refer to <b>Section 3.3</b>		
	Soil testing and weed control in preparation for ripping, soil amelioration and revegetation works	Approx. 2.5ha - LW14 area complete	As required	-	
	Ripping, soil amelioration and revegetation works	-	Approx. 2.5ha - LW14 area	Batter areas within LW15/16 and new construction works (chutes 10, 7 and 3), instability area 01 and LW15/16 area and road realignment	

Task <sup>1</sup>	Task Description	2019	2020	2021	2022-2023		
Further assessment	Stabilisation - further assessment of areas of instability		Sites 01 and 05 – assessment	Sites 01 and 05 – include results in 2021 revised Plan			
Monitoring, Maintenance and Review	Annual Diversion and Subsidence Monitoring	Complete	As per <b>Table 17</b> <sup>4</sup>	As per <b>Table 17</b>	As per <b>Table 17</b>	As per <b>Table 17</b>	As per <b>Table 17</b>
	Monthly monitoring and maintenance		Following areas revegetated in 2020 <sup>5</sup>	Following areas revegetated in 2020 and 2021 <sup>5</sup>	-	-	-
	Development of work program for following year – to be included in Annual Review		By 30 December	By 30 December	By 30 December	By 30 December	By 30 December
	NWCD Management Plan review/revision if required		-	By 30 June	By 30 June	By 30 June	By 30 June
	Performance criteria			Refine criteria	Include revised criteria in 2022 revised Plan -	-	-
	Undertake review of works completed to date with stakeholders.		-	As part of Annual Review	As part of Annual Review	As part of Annual Review	As part of Annual Review

1. Refer to **Figure 7** and **Figure 8** for location of proposed works and instability areas.
2. Construction of Chute 10 will only commence following a full review of the 2020 works program, as part of the Annual Review.
3. Native grass seed collection will only continue past 2021 if the 2020 native grass trial is successful. This trial will be reviewed as part of the Annual Review process.
4. Monitoring of areas of instability at Sites 02, 03, 04, 06, 08 and 09 will be included in the annual monitoring program in 2020.
5. Monthly inspections and maintenance as required until vegetation established. Review as part of 2021 NWCD Management Plan revision.
6. Repairs required following a significant flow event early 2020.

### 3.4.1.1 Overview of works to be undertaken

The proposed works in **Table 12** include chute construction and repair, channel stability works and revegetation works. These works are also detailed further in **Appendix C** which includes priorities for the completion of the works. A range of works will be undertaken each year and these works include:

- Review of this plan to confirm there are no changes required to the plan;
- Review of the works undertaken in the previous year to confirm whether there are any amendments or improvements which can be made to chute design or repairs;
- Monitoring required to be undertaken as detailed in **Section 4.2**; and
- Reporting of works undertaken during the year as detailed in **Section 5.1**.

The works detailed below are the works as recommended in **Appendix C**. WCPL have provided a conceptual scope of works to be undertaken in 2019 and 2020, with the scope of works to be undertaken in 2021 – 2023 to be confirmed in subsequent reviews of this plan.

#### **Construction and Earthworks – Chute Construction and Repairs**

The methods for the earthworks repairs and the design information for the chute construction and repair works are conceptually included in **Appendix C**.

The schedule for the completion of the construction and repair of chutes within the NWCD has been recommended by Alluvium based on the review undertaken by Alluvium in 2019. Batter chute design specifications are included in **Appendix C**.

The proposed program for the batter chute construction and repairs prioritised the construction of new chutes 10, 11 and 12 with remaining chute 9 to be constructed the following year following a review of the performance of the chutes constructed. The location of these new chutes is shown on **Figure 7**. Due to restrictions associated with the construction of an overhead powerline, which interfered with the construction of the batter chutes, construction of the batter chutes were re-prioritised in 2019, resulting in the construction of chute 10 being delayed until 2021. Batter chutes 8, 9, 11 and 12 were constructed in 2020. The location of batter chute 10 will likely be relocated from its proposed location, now that subsidence impacts have been fully assessed.

As detailed in **Appendix C**, there are a number of other batter chutes proposed to be constructed. The plan detailed in **Table 12** has committed to the construction of the initial 5 batter chutes with the remaining batter chutes to be constructed following the development of a scope of works in 2021.

Batter chute repairs are proposed to commence in 2021. Batter chute repairs will be undertaken in accordance with the recommendations in the Detailed Rehabilitation Plan (**Appendix C**) and further assessments made in 2020.

#### **Stabilisation Works**

There are areas of instability noted in **Appendix C** which will not be repaired as part of the program to construct new chutes and repair existing chutes.

Works to be undertaken in these areas include battering of eroded banks, application of topsoil and revegetation. Stabilisation works to be undertaken will initially focus on works within LW 15 and LW 16, as these areas have been subsided and are not expected to be further

impacted. Stabilisation works within LW panels 17 – 19 will not commence until mining has finished in these areas. The schedule for these works will be detailed in future revisions of this plan.

There are two locations (Sites 1 and 5 on **Figure 8**) which have been identified by Alluvium as areas of instability which require further assessment to identify appropriate management actions. This assessment will commence in 2020.

### **Ripping, Soil Amelioration and Revegetation**

There are areas of the NWCD that require ripping and revegetation. These areas are located in the LW14 area and are shown on **Figure 7**. Works required to be undertaken include soil testing, weed management, soil amelioration, ripping and revegetation. The NWCD Revegetation Management Plan (Cumberland Plains Seeds), was developed during 2019.

### **Revegetation Trial**

WCPL will also undertake a native grass trial in areas of the NWCD during the MOP period, as part of the 5YR RMP. This trial will be undertaken in consultation with Wambo's environmental consultants, with the results to be included in the Annual Review.

#### **3.4.1.2 Program Summary for 2019**

In 2019 the objective was to establish the management framework and stakeholder consultation program for the ongoing management of the NWCD over the next five years. The construction of new batter chutes were delayed until 2020 (refer to **Appendix C**).

Works undertaken in 2019 are detailed in **Table 12** and included:

- Consultation with relevant stakeholders for this revised plan;
- Development of a Revegetation Strategy for NWCD to identify proposed planting program for Years 2019 – 2023;
- Diversion and subsidence monitoring;
- Collection of native grass species for revegetation works proposed to be undertaken in LW 14 including the planting of approximately 2.5 hectares; and
- Batter chute construction planning works including the development of tender documentation and contract scopes.

#### **3.4.1.3 Program Summary for 2020**

The works to be undertaken in 2020 are detailed below. Standard annual tasks detailed in **Section 3.4.1.1** will be undertaken in addition to the following:

- Construction of batter chute 8, 9; 11 and 12;
- Commencement of further assessment for Sites 1 and 5 (areas of instability);
- On ground civil works to be completed for selected new batter chutes;
- Implementation of the Revegetation Strategy; and
- Review of further assessment of stabilisation works for Sites 1 and 5. The 2020 Annual Review will detail proposed works for these locations based on the outcomes of the investigation undertaken in 2020.



#### 3.4.1.4 Program Summary for 2021-2023

The scope of works to be undertaken during 2021 – 2023 will be refined in subsequent revisions of this plan. As detailed in the above sections, in the initial years of 2020 and 2021 chute construction and batters works will be undertaken and this, in combination with the annual monitoring required to be completed, will be utilised for the development of the 2022 – 2023 program.

#### 3.4.1.5 Implementation

In 2019, Soil Conservation Services (SCS) were engaged to design and construct the remediation works, whilst respecting and referring to the modelling, research and action plans for the NWCD conducted by Alluvium in the following reports:

- Design Report: North Wambo Creek Detailed Rehabilitation Plan (April 2019);
- Technical Specification – Diversion Stabilisation Works: NWCD Detailed Action Plan Detailed Design (April 2019);
- Report: North Wambo Creek Diversion Operations Monitoring 2018 (December 2018);
- Report: North Wambo Creek – Baseline assessment geomorphic context statement (February 2018);
- Report: Surface Water Technical Report for South Bates Underground Mine (Longwalls 11 – 16) Wambo Coal Mine (December 2016); and
- Report: North Wambo Creek diversion – review of condition and performance (November 2015).

SCS are progressing on schedule with the 2020 program of work, as outlined in **Table 12**.

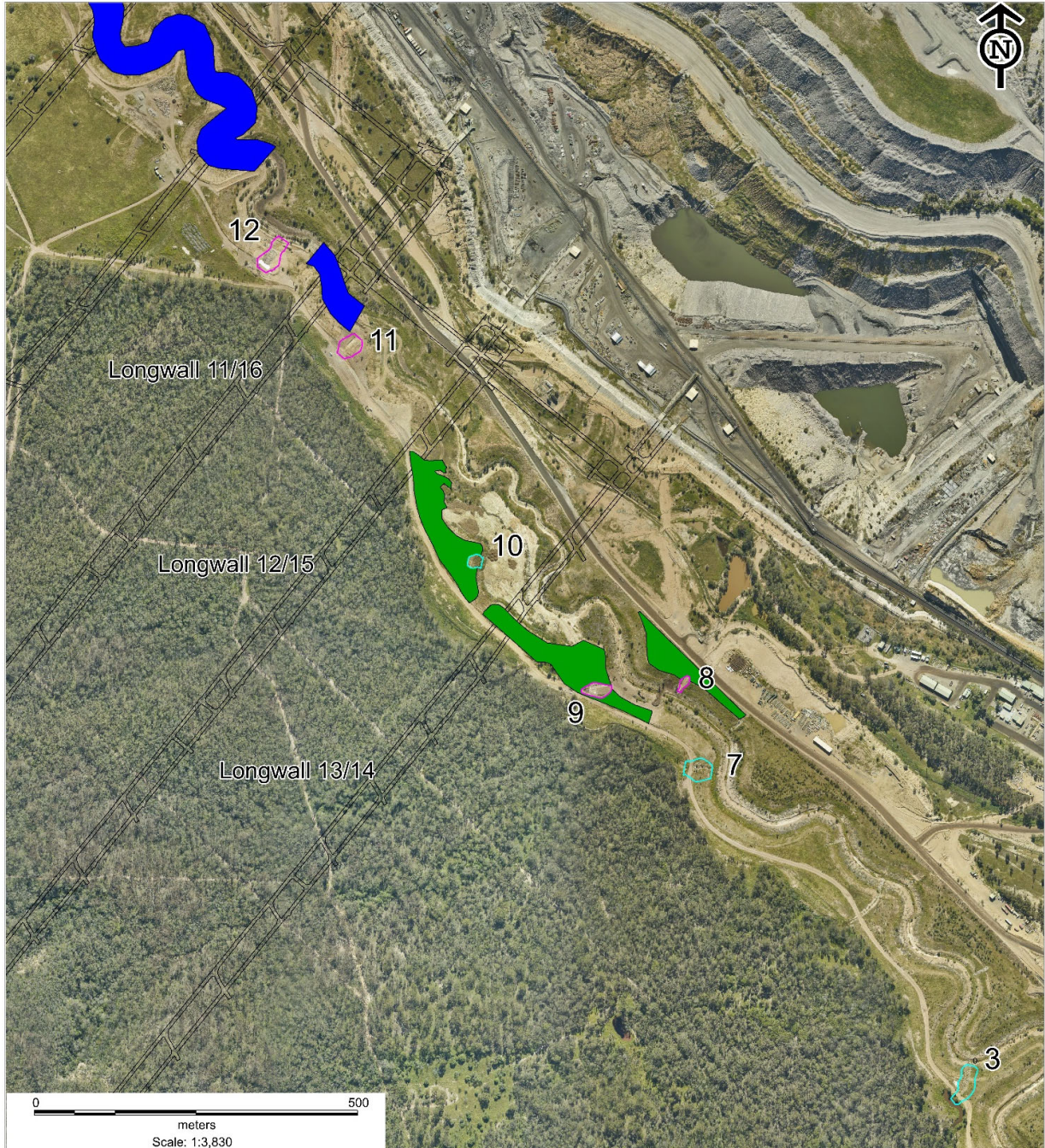

<b>Legend</b> <ul style="list-style-type: none"> <li><span style="color: magenta;">—</span> 2020 Chute Constructs</li> <li><span style="color: cyan;">—</span> 2021 Chute Constructs</li> <li><span style="color: blue;">■</span> 2020 Stabilisation Areas</li> <li><span style="color: green;">■</span> 2020 Rip Areas</li> <li><span style="border: 1px solid black; display: inline-block; width: 10px; height: 10px;"></span> Underground Mine Workings</li> </ul>	<b>North Wambo Creek Diversion</b> <b>2020-2021 Remediation Works</b>	
	Date: 20/07/2020	
	Author: KH	
	Approved By: PJ	
	Version: 1	
Projection: MGA 94 Zone 56		

**Figure 7: NWCD 2020-2021 Remediation Works**

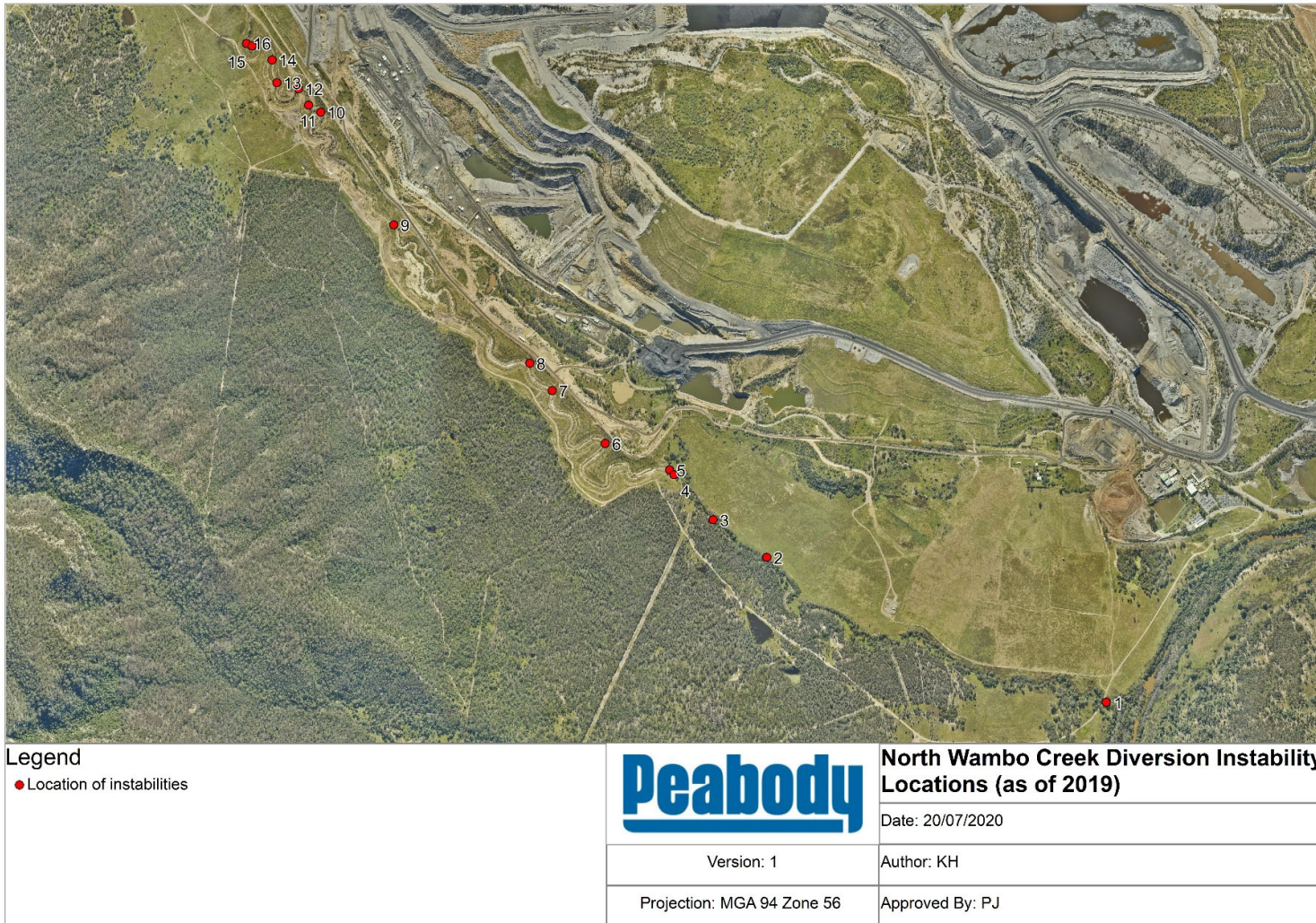

**Figure 8: NWCD Instability Locations (as of 2019)**

### 3.5 Intercepted Groundwater

Previous versions of the Development Consent required WCPL to return intercepted ground water from the NWCD to the alluvial aquifer downstream of the open cut. This requirement was removed from the Development Consent in Modification 16 (August 2019).

Since December 2017, three (3) separate investigative drilling programs have been undertaken in the North Wambo Creek alluvium, upstream of the North Wambo Creek Diversion, resulting in 33 investigative holes drilled. Thirteen of these have been converted in to alluvial (11) and weathered Permian (2) monitoring bores. Continuous groundwater level loggers have been installed at two (2) sites to capture rapid changes in groundwater level within the North Wambo Creek alluvium associated with intense weather events and periods of flow in North Wambo Creek. Further detail on the monitoring program for these bores is included in the WCPL GWMP.

Following regulator comments received on the NWCD MP (Version 1), the HydroSimulations (2018) groundwater model was updated to include greater temporal variability to better capture groundwater conditions along North Wambo Creek. The alluvium and shallow weathered rock are noted to be less broadly saturated following the construction of the NWCD and interception of alluvial material by the Montrose Open cut. The report notes that *'The existing groundwater monitoring network has a good spatial spread, with bores monitoring the alluvium and the weathered sandstone'*.

It is anticipated that further backfilling of the Montrose open cut mine, already undertaken across the alluvial aquifer intercept, will consolidate over time, reducing hydraulic conductivity. WCPL will continue to account for intercepted groundwater in the annual water balance which is reported in the Annual Review.

## 4.0 Measurement and Evaluation

The performance and completion criteria within the following sections include the criteria from existing WCPL management plans and monitoring programs. Performance and completion criteria included in **Section 4.1** will be reviewed by WCPL in 2020/2021.

### 4.1 Performance and Completion Criteria

Preliminary performance completion criteria and indicators have been developed for the NWCD (Domain 7) for all rehabilitation phases except relinquishment. These criteria and performance indicators are detailed in the MOP and have not been included in this Plan.

Specific performance indicators and completion criteria have been developed for the NWCD for geomorphology, surface water (quality and flow) and LFA. Further information on the development of these performance indicators and completion criteria is provided in the WCPL SWMP and WCPL BMP.

#### 4.1.1 Geomorphological Triggers and Success Criteria

Geomorphological triggers and success criteria were developed as part of the detailed design of the NWCD (Gilbert and Associates, 2007). These triggers and criteria relate to the performance of the NWCD in flood conditions (refer to **Table 13**). As noted in **Section 2.1.9.1**, the geomorphological triggers will be reviewed in 2020/2021.

**Table 13: Geomorphological Response to Flood Events – Triggers and Success Criteria**

Flood Event	Attribute	Success Criteria*	Trigger
Extreme i.e. >100 year ARI	Bank erosion, siltation of over bank and in-channel deposition and bed scour features	Frequency and magnitude of attribute are not more than: <ul style="list-style-type: none"> <li>100% greater than the average of the same attributes in the control reaches or</li> <li>50% greater than the greatest as measured in any of the control reaches</li> </ul>	Severe erosion of bed and banks or over bank scour which would likely lead to an ongoing threat to the integrity of the diversion and the pit bund
Major i.e. 20-100 year ARI	Bank erosion, siltation of over bank and in-channel deposition and bed scour features	Frequency and magnitude of attribute are not more than: <ul style="list-style-type: none"> <li>100% greater than the average of the same attributes in the control reaches or</li> <li>50% greater than the greatest as measured in any of the control reaches</li> </ul>	Bank slips, undermining or over bank scour would likely lead to ongoing instability in either the diversion or the pit bund
Medium i.e. 5-20 year ARI	Bank erosion, siltation of over bank and in-channel deposition and bed scour features	Frequency and magnitude of attribute are not more than: <ul style="list-style-type: none"> <li>100% greater than the average of the same attributes in the control reaches or</li> <li>50% greater than the greatest as measured in any of the control reaches</li> </ul>	Severe erosion of bed and banks or over bank scour which would likely lead to ongoing degradation of the diversion or the pit bund
Small to medium i.e. <5 year ARI peak discharge but sufficient to cause	Bank erosion, siltation of over bank and in-	Frequency and magnitude of attribute are not more than:	Erosion of bed and banks or over bank scour which would likely lead to

Flood Event	Attribute	Success Criteria*	Trigger
measurable responses/changes in either the diversion or the control reaches.	channel deposition and bed scour features	<ul style="list-style-type: none"> <li>50% greater than the average of the same attributes in the control reaches or</li> <li>25% greater than the greatest as measured in any of the control reaches</li> </ul>	accelerated erosion or instability of the diversion and the pit bund

\* Determined as a result of a survey

#### 4.1.2 Surface Water Triggers and Success Criteria

The performance and completion criteria for the diversion are outlined in **Table 14**. Further discussion on the triggers/criteria and specific Trigger Action Response Plans (TARPs) is included in the WCPL SWMP. TARPs relevant to the diversion are included in **Section 4.3**.

Table 14: Performance Criteria for the North Wambo Creek Diversion

Parameter	Trigger/Criteria	Comment	Relevant Management Plan
<b>Water Quality</b>			
pH	Lower limit: 7.3 Upper Limit: 7.9	The TARP for these triggers is included in <b>Section 4.3</b> .	SWMP
EC	Lower limit: 1,155 µS/cm Upper Limit: 2,246 µS/cm		
TSS	Low Flow: 53 mg/L High Flow: 1,110 mg/L		
<b>Stream Flow</b>			
Flow	Flow recorded following 100mm* of rainfall	There are currently no TARPS established for stream flow, specific to the NWCD.**	SWMP

\*revised as outlined in **Section 2.3**

\*\* Performance and completion criteria are to be developed with a better informed understanding of the likely surface hydrologic regime of the diversion with monitoring data collected over the next 5-10 years.

#### 4.1.3 LFA Target Scores

Target scores were developed to provide quantitative measures that can be used to compare rehabilitation areas with reference sites throughout the course of the monitoring program (**Section 4.2**). These scores were developed using the data in **Section 2.1.8** as well as data from nearby sites within relatively undisturbed riparian habitat.

A colour system (**Table 15**) has been devised to highlight the performance of LFA sites against the target scores in **Table 16**. The colour system is applied to the average score from monitoring of LFA sites within the NWCD rehabilitation area.

Table 15: Colour system devised to highlight the performance of each LFA site

Performance Rating			
Green	Yellow	Orange	Red
Area is generally meeting or exceeding target values and values do not show trend of decline over time – where monitoring sites are meeting targets and values are relatively consistent, reduce monitoring to infrequent LFA when changes in landscape or	Area generally falls below target values but within 75% of targets or appears to be on a trajectory of improvement without the need for management intervention – further monitoring required	Area generally falls between 75% and 50% of target values or shows little sign of improvement over several monitoring events – further monitoring and possibly management actions required	Area falls below 50% of target and is unlikely to improve without management actions or shows trend of decline which is unlikely to improve without management actions

Performance Rating			
Green	Yellow	Orange	Red
management practices occur i.e. fire or grazing)			

The ongoing use of LFA will be result-based, with achievement of a self-sustaining stable landform no longer requiring further monitoring. Incremental improvement toward target scores is anticipated in each successive monitoring season. Failure to progress towards completion criteria for three consecutive years will trigger further investigation, in accordance with the WCPL BMP.

Table 16: LFA targets for the NWCD

	Landscape Organisation Index	Stability Index	Infiltration	Nutrient Index
Target Score	>84	>62	>41	>37
2017 average score*	0.63	56.25	32.96	26.05

\* refer **Section 2.1.8**

If there is less than 5% annual improvement or a decline in the LFA target score (from the previous monitoring round) then this will trigger a response in accordance with the WCPL BMP (refer to TARP in **Section 4.3.2** of this Plan).

## 4.2 Monitoring Program

The diversion monitoring program is designed to regularly monitor and inspect the water quality, ecology, hydrology and geomorphic integrity to ensure identification of any issues and efficient remediation can be actioned where required. The diversion monitoring program is summarised in **Table 17**. Monitoring locations are shown on **Figure 9** and **Figure 10**. Further detail on the monitoring programs is provided in the relevant management plans.

Monitoring data is compared to the performance criteria detailed in **Section 4.1**. If any unsatisfactory performance is identified, the actions and follow up required will be recorded as part of the monitoring observations and as described in the Trigger Action Response Plans (**Section 4.3**).

Reporting on the performance of the diversion and the diversion monitoring program is undertaken as part of the Annual Review process (**Section 5.1.1**). The process for reporting environmental incidents is described in **Section 5.1.2**.

Table 17: Diversion Monitoring Program

Component	Site	Parameter	Frequency	Purpose	Relevant Management Plan
<b>Water Quality and Stream Flow</b>					
Water Quality	SW05	pH, EC, TSS	Monthly/ Rainfall Event	Monitoring water quality of North Wambo Creek downstream of Wambo Coal Operations	SWMP
	SW27a			Monitoring water quality at North Wambo Creek (middle of diversion)	
	SW32a			Monitoring water quality at North Wambo Creek Pump	
	SW04	pH, EC, TSS, metals and ions (including sulfates)	Monthly/ Rainfall Event	Monitoring water quality of North Wambo Creek upstream of North Wambo Creek Diversion, including monitoring for metals and ions (including sulfates) until March 2020 for baseline data	
US FM1	Monitoring water quality of upper reaches of North Wambo Creek, including monitoring for metals and ions (including sulfates) until March 2020 for baseline data				
Stream Flow	FM1	Flow	Continuous	Monitoring of flow in North Wambo Creek – confluence	SWMP
	FM2			Monitoring of flow in North Wambo Creek – middle of diversion	
	FM3			Monitoring of flow in North Wambo Creek	
	FM4			Monitoring of flow in North Wambo Creek - downstream near confluence of Wollombi Brook	
	US FM1			North Wambo Creek - upstream	
<b>Diversion and Subsidence Monitoring Program – Operational Monitoring</b>					
Index of Diversion Condition	Upstream reach (U1-U4), NWCD Stage 2 (Div1-Div5), NWCD Stage 3 (Div 6 – Div11), Above completed North Wambo Underground (WS1-WS6) and Downstream reach (D1-D2)	Geomorphic Index and Riparian Index Photo recording	Annually*	IDC provides a rapid assessment of the diversion and adjoining reaches of interest along the watercourse and is designed to flag potential management issues rather than provide a detailed scientific assessment of the waterway. The assessment uses current aerial photos, LIDAR data, mine plans and flow monitoring data.	Extraction Plan for LWs 11-16 (Subsidence Monitoring Program)  SWMP
Landscape Function	NWCD Stage 2 (17R, 19R, 21R, 23R)	Landscape Organisation Index and Soil	Annually (Autumn or Spring)	Monitoring of established LFA transects in areas of revegetation along the diversion and a corresponding reference site on Wambo Creek.	BMP  SWMP



Component	Site	Parameter	Frequency	Purpose	Relevant Management Plan
Analysis (LFA)	NWCD Stage 3 (25R, 26R, 27R & 28R) and W14R (Wambo Creek reference site)	Surface Assessment			
Riparian Vegetation	Same as IDC monitoring sites	Vegetation structure and extent	Annually *		BMP SWMP
	8A, 9A, 10A, 11A, 12A, 13A, 14A, 15A	Rapid Appraisal of Riparian Condition (RARC) Index	Annually	Monitoring of riparian vegetation in the North Wambo Creek Diversion, using the RARC index, as well as a visual assessment of the impact of erosion and subsidence (as part of an ongoing photographic record).	BMP
Aerial Photography	Full reach of NWCD and North Wambo Creek downstream	Changes to channel form compared to previous aerial photographs.	Annually *		SWMP
Long And Cross-Section Surveys - Creek Bed and Bank Stability	Various cross sections	Changes to channel form compared to previous surveys.	Annually	Locations extracted from LiDAR or aerial photogrammetry survey data captured over NWCD and North Wambo Creek downstream. Monitoring of bed and bank stability by surveying consultants to measure areas if significant erosion and identify changes related to creek bed condition and water flow.	SWMP
Annual Subsidence Inspection	Areas impacted by subsidence	Subsidence Inspection	Annually	Inspection to identify any surface disturbance, assess the level of disturbance to native vegetation and assess any changes in the diversion due to subsidence.	BMP
Daily Subsidence Inspection	Areas impacted by subsidence	Surface cracks and ponding	Daily during undermining	Daily inspections when extraction is occurring directly beneath North Wambo Creek Diversion.	Extraction Plan for LWs 11-16 and LWs 17-20
<b>Other</b>					
Freshwater Macro-invertebrate	1D, 12D	Freshwater Macro-invertebrate Study	Every 5 years (2021, 2026 etc)	Monitoring of freshwater macroinvertebrates in the North Wambo Creek Diversion, including assessment of SIGNAL A values. Water quality data to (EC, pH and temperature) to be sourced from scheduled surface water monitoring.	BMP

Component	Site	Parameter	Frequency	Purpose	Relevant Management Plan
Weeds	Stage 3	Weeds	In accordance with Annual Weed Treatment Plan	Weed management of NWCD Stage 3 will be monitored by a weed inspection regime and will be included in the Wambo Annual Weed Treatment Plan	BMP
Discharge Flows	Entire diversion	Bankfull discharge flow capacity and velocity	Annually (as part of Annual Review)	Calculation of Bankfull discharge flow capacities and velocities in the diversion.	SWMP
Diversion Stability <sup>^</sup>	Entire diversion <sup>^</sup>	Diversion stability		Assessment of diversion stability performance, compared with selected stable reaches of North Wambo Creek and other control catchments, as approved by DPI Water	
Diversion Construction and Rehabilitation Monitoring	Areas impacted by construction or rehabilitation works	General environment	As required during and immediately after construction of mitigation or rehabilitation works along the NWCD	Monitoring to confirm that works have been undertaken to specification and/or meet design intent.	SWMP

\*Frequency may be reduced following the completion of subsidence from the South Bates Underground Mine.

<sup>^</sup> new monitoring sites added in 2019 in response to the identification of areas of instability, as detailed in the Detailed Rehabilitation Plan for the NWCD (**Appendix C**). Monitoring locations include Sites 02, 03, 04, 06, 08 and 09 (refer **Figure 7**).

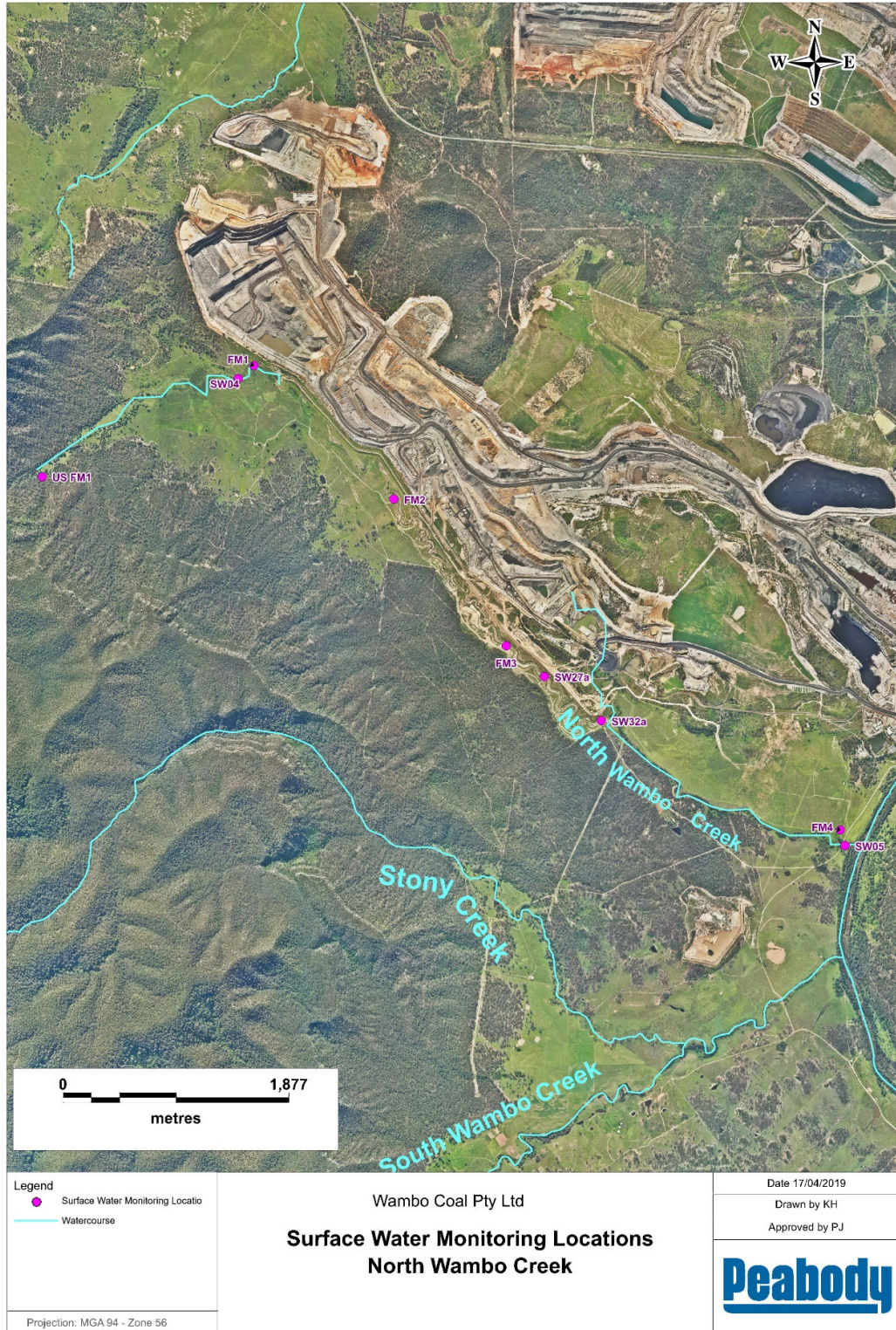

**Figure 9: Diversion Surface Water Quality and Stream Flow Monitoring Program**

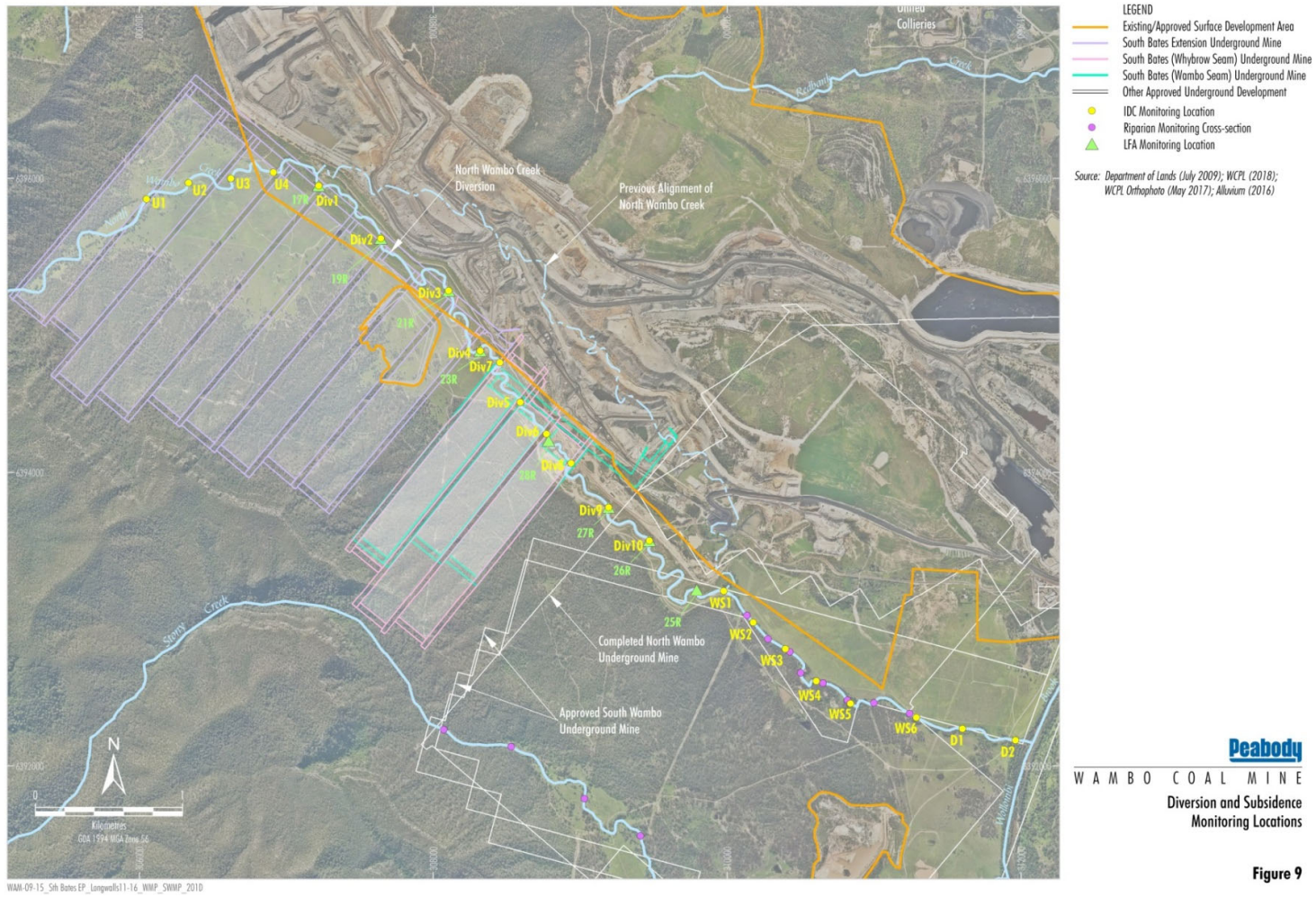

Figure 10: Diversion and Subsidence Monitoring Program – Operational Monitoring

### 4.3 Trigger Action Response Plans

A range of TARPS have been developed for the NWCD. These TARPS have been developed and included within existing WCPL Management Plans and strategies, with the TARPS being included in the following sections.

TARPS have been developed for key aspects of the performance of the NWCD and include TARPs for surface water, subsidence and LFA. These TARPs will continue to be refined as further monitoring data is obtained and following receipt of regulatory agency comments and DPE approval of this Plan.

The TARPS include preliminary reviews of trending data after two consecutive events are observed, with investigations required to be undertaken by WCPL if three consecutive events are observed. Two consecutive events require the initiation of the Level 1 response with three consecutive events requiring instigation of the Level 2 response.

TARP's for the management of subsidence are included in the respective Extraction Plans.

Additional TARPs will be developed to address geomorphic factors as well as specific TARPs for the civil works as detailed in **Section 3.4**.

#### 4.3.1 Surface Water TARP

The TARP in **Table 18** will be implemented in the event that surface water monitoring of North Wambo Creek, for pH, EC and TSS, identifies water quality results exceeding the 80<sup>th</sup> Percentile Trigger Value, as identified in the WCPL SWMP, after two consecutive sampling events.

**Table 18: TARP for North Wambo Creek Diversion Performance – Surface Water\***

TARP Code	Level 1 Response Management Measures	Level 2 Response Contingency Phase
Trigger	<ul style="list-style-type: none"> <li>•Surface water monitoring of North Wambo Creek, for pH, EC and TSS, identifies water quality results exceeding the 80<sup>th</sup> Percentile Trigger Value, as identified in the SWMP, after two consecutive sampling events; and/or</li> </ul>	<ul style="list-style-type: none"> <li>•Surface water monitoring of North Wambo Creek for pH, EC and TSS, identifies water quality result exceeding the 80<sup>th</sup> Percentile Trigger Value, after three consecutive sampling events.</li> </ul>
Action	<ul style="list-style-type: none"> <li>•Review recent rainfall data to identify potential correlation between decreasing water level trends and extended dry periods.</li> <li>•Maintain monitoring of surface water sites to identify if water quality results are trending back to long term averages as identified in the SWMP.</li> <li>•If any water quality exceeds the 80<sup>th</sup> Percentile Trigger Value (three consecutive periods), then go to Level 2 Response.</li> </ul>	<ul style="list-style-type: none"> <li>•Continue surface water monitoring to determine if decline trends have stabilised and displaying signs of improving trends in consecutive monitoring periods.</li> <li>•Wambo will undertake preliminary investigation as soon as possible, including:               <ul style="list-style-type: none"> <li>- Undertaking an investigation to review surface water monitoring results in conjunction with site activities being undertaken at the time, the prevailing and preceding meteorological conditions and changes to the landuse/ activities being undertaken.</li> </ul> </li> <li>•If confirmation of a results and investigations from above confirms impacts, Wambo will notify the relevant government agencies and in consultation develop appropriate remedial measures if required.</li> </ul>
Plan	Data obtained from monitoring to be utilised as part of ongoing refinement of criteria.	<ul style="list-style-type: none"> <li>•Review and update the WCPL WMP and resubmit to DPIE within 3 months, or as otherwise agreed.</li> </ul>

\* This TARP is consistent with the "TARP for North Wambo Creek Diversion Performance" in the WCPL SGWRP (Version 12).

### 4.3.2 LFA Monitoring TARP

The TARP in **Table 19** will be implemented in the event that LFA monitoring of riparian areas identifies a potential decline in creek stability, beyond natural fluctuations.

**Table 19: TARP for North Wambo Creek Diversion Performance – Biodiversity\***

TARP Code	Level 1 Response Management Measures	Level 2 Response Contingency Phase
Trigger	•Monitoring of LFA of riparian areas identifies a potential decline in creek stability, beyond natural fluctuations – refer to <b>Section 4.1.3</b> .	•Monitoring of LFA of riparian areas <sup>^</sup> identifies a decline in creek stability in consecutive monitoring events, beyond natural fluctuations.
Action	<ul style="list-style-type: none"> <li>•Continue annual LFA and aquatic ecosystems monitoring to determine if decline trends have stabilised and displaying signs of improving trends in consecutive monitoring periods.</li> <li>•If consecutive LFA and aquatic ecosystems monitoring events show continued decline trends and displaying no signs of improving trends, then go to Level 2 Response.</li> </ul>	<ul style="list-style-type: none"> <li>•Continue annual LFA and aquatic ecosystems monitoring to determine if decline trends have stabilised and displaying signs of improving trends in consecutive monitoring periods.</li> <li>•Wambo will undertake preliminary investigation as soon as possible, including:               <ul style="list-style-type: none"> <li>- Undertaking an investigation to review monitoring results in conjunction with site activities being undertaken at the time, the prevailing and preceding meteorological conditions and changes to the landuse/ activities being undertaken.</li> </ul> </li> <li>•If confirmation of a results and investigations from above confirms impacts, Wambo will notify the relevant government agencies and in consultation develop appropriate remedial measures if required.</li> </ul>
Plan	Data obtained from monitoring to be utilised as part of ongoing refinement of criteria.	•Review and update the WCPL BMP and resubmit to DPIE within 3 months, or as otherwise agreed.

\*This TARP is consistent with the TARP in the WCPL BMP and the “TARP for North Wambo Creek Diversion Performance” in the WCPL SGWRP (Version 12).

<sup>^</sup> Monitoring undertaken in accordance with the WCPL BMP.

### 4.3.3 Subsidence TARP

WCPL has developed a TARP to manage subsidence impacts on surface and groundwater as a result of underground mining. This TARP is detailed within the **North Wambo Creek Diversion Subsidence Response Strategy – SBU and SBU Extension Mine** which forms part of approved Extraction Plan. A copy of this strategy is included in **Appendix E**.

Triggers and actions specifically related to the NWCD are summarised in **Table 20** below.

Table 20: Subsidence TARP for the North Wambo Creek Diversion

Condition	Normal	Level 1	Level 2
	Normal conditions	Management Measures	Restoration/Contingency Phase
Trigger	<ul style="list-style-type: none"> <li>No visible cracks along North Wambo Creek Diversion.</li> </ul>	<ul style="list-style-type: none"> <li>Cracks observed along North Wambo Creek Diversion.</li> </ul>	<ul style="list-style-type: none"> <li>Functionality of North Wambo Creek Diversion materially affected.</li> </ul>
Action	<ul style="list-style-type: none"> <li>Conduct monitoring, consistent with <b>Table 17</b> of this plan, the GWMP, SWMP and the Subsidence Monitoring Program (Appendix H of the Extraction Plan).</li> <li>Assess the environmental consequences of the subsidence in accordance with Section 1.2 of the NWCSRS (<b>Appendix E</b>).</li> <li>Assess the need for management measures in accordance with Section 2.2 of the NWCSRS (<b>Appendix E</b>).</li> </ul>	<ul style="list-style-type: none"> <li>Implement management measures, as required, in accordance with Section 2.2 of the NWCSRS (<b>Appendix E</b>).</li> <li>Continue monitoring, consistent with <b>Table 17</b> of this plan, the GWMP, SWMP, and the Subsidence Monitoring Program (Appendix H of the Extraction Plan).</li> </ul>	<ul style="list-style-type: none"> <li>Develop and implement an action plan for additional measures*, including consideration of:               <ul style="list-style-type: none"> <li>additional scour protection, crack remediation and/or stabilisation; and/or</li> <li>isolation sealing of the diversion cutting, for example through injection grouting or installation of low permeability material.</li> </ul> </li> </ul>
Frequency	<ul style="list-style-type: none"> <li>Monitoring as per <b>Table 17</b> of this plan, the GWMP, SWMP and the Subsidence Monitoring Program (Appendix H of the Extraction Plan).</li> <li>Assessment of consequences and need for management measures, as required (dependent on monitoring results)</li> </ul>	<ul style="list-style-type: none"> <li>As required, in accordance with Section 2.2 of the NWCSRS (<b>Appendix E</b>).</li> </ul>	<ul style="list-style-type: none"> <li>As required, in accordance with Section 2.2 of the NWCSRS (<b>Appendix E</b>).</li> </ul>
Position of Decision Maker	<ul style="list-style-type: none"> <li>Environment and Community Manager.</li> </ul>	<ul style="list-style-type: none"> <li>Environment and Community Manager.</li> </ul>	<ul style="list-style-type: none"> <li>General Manager.</li> </ul>

\*Implementation of additional management measures will be undertaken in consultation with the RR and DPI Water.

#### 4.4 Non-compliances with Statutory Requirements

Non-compliances with the performance criteria detailed in **Section 4.1** will be managed in accordance with the relevant TARP (**Section 4.3**). Environmental incidents that cause or have the potential to cause harm to the environment will be reported in accordance with **Section 5.1.2**. Any other non-compliances with statutory requirements will be investigated and the results of this investigation will be reported in the Annual Review.

#### 4.5 Complaints

Any complaints received regarding the diversion will be handled in accordance with the complaints management procedure detailed in the Wambo EMS.

## 5.0 Review and Improvement

### 5.1 Reporting

#### 5.1.1 Annual Review

Wambo will review the performance of the diversion on an annual basis and report on any significant findings in the Annual Review. The Annual Review will be provided to DPIE and will be available on the Wambo website.

The Annual Review will detail the works which have been undertaken during the report period and will also provide an update against the actions as detailed in **Section 3.4** whilst also detailing the actions to be undertaken for the following 12 months. The action plan, as shown in **Section 3.4.1**, will be included in further detail for each year within the Annual Review.

#### 5.1.2 Reportable Environmental Incidents

In accordance with the Pollution Incident Response Management Plan (PIRMP), WCPL must notify all relevant authorities of incidents causing or threatening material harm to the environment immediately after the person becomes aware of the incident in accordance with the requirements of *Part 5.7* of the *POEO Act*. This will be undertaken as required by the WCPL E&C Manager in accordance with WCPL's PIRMP.

### 5.2 Plan Review

WCPL will review, and if necessary, revise the NWCD Plan (in accordance with Condition D6 of DA 305-7-2003) within three months of:

- The submission of an Annual Review;
- The submission of an incident report;
- The submission of an independent environmental audit; or
- Any modification to the development consent (excluding Mod 16).

The Plan will also be reviewed:

- Prior to new underground mining areas being developed,
- Following continual exceedance of trigger values; or
- If there is a relevant change in technology, practice or legislation.

The revised Plan will be re-submitted to the Secretary for approval as required.



## 6.0 Accountabilities

**Table 21** summarises accountabilities associated with this Plan.

**Table 21: Accountabilities**

No	Task	Accountability	Timing
1	Provide adequate resources for the implementation of this Plan.	General Manager	As required
2	Implement this Plan	Environment and Community Manager	As required
3	Ensure monitoring, inspections and visual assessments after high rainfall events are undertaken	Environment and Community Manager	As required

## 7.0 Acronyms

**Table 22** lists the acronyms used throughout this Plan.

**Table 22: Acronyms**

Acronym	Description
AHD	Australian Height Datum
ARI	Average Recurrence Interval
BMP	WCPL Biodiversity Management Plan
CLWD	Crown Lands and Water Division within Department of Primary Industry
DA	Development Approval
DPI - Water	NSW Department of Industry – Water (Formerly DWE)
DoP	NSW Department of Planning
DPIE	NSW Department of Planning, Industry and Environment (formerly DoP)
DPIE Water Group	NSW Department of Planning, Industry and Environment – Water (DPIE Water and the Natural Resources Access Regulator)
DPI	NSW Department of Primary Industries
DWE	NSW Department of Water and Energy
EC	Electrical Conductivity
EIS	Environmental Impact Statement
EP&A Act	Environmental Planning & Assessment Act 1979
EPL	Environment Protection Licence
GWMP	WCPL Groundwater Management Plan
IEA	Independent Environmental Audit
LFA	Landscape Function Analysis
LW	Longwall
MOP	Mining Operations Plan
NWCD	North Wambo Creek Diversion
NWCSRS	North Wambo Creek Subsidence Response Strategy
NWU	North Wambo Underground
PIRMP	WCPL Pollution Incident Response Management Plan
RARC	Rapid Appraisal of Riparian Condition
RMP	Remediation and Monitoring Program
RR	Resources Regulator - DPIE (formerly DPI)
SBU	South Bates Underground
SGWRP	WCPL Surface and Groundwater Response Plan
SWMP	WCPL Surface Water Management Plan
TARP	Trigger Action Response Plan
TDS	Total Dissolved Solids
TSS	Total Suspended Solids
WCPL	Wambo Coal Pty Ltd
WMP	WCPL Water Management Plan

## 8.0 References

### 8.1 Legislation

- Environmental Planning and Assessment Act 1979
- Protection of the Environment Operations Act 1997

### 8.2 Approvals, Modification Applications and Assessments

- Development Consent (DA305-7-2003)
- Wambo Development Project Environmental Impact Statement, volumes 1-5, dated July 2003, prepared by Resource Strategies Pty Ltd (Project EIS)
- Wambo Development Project – Modification of DA 305-7-2003-I; dated 27 July 2006 (Mod 5)
- Wambo Development Project – Modification of DA 305-7-2003-I; dated 21 September 2006 (Mod 6)
- Wambo Coal Mine Modification Statement of Environmental Effects; dated September 2006 (Mod 6)
- Modification application DA 305-7-2003 MOD 16 and accompanying documents titled *United Wambo open cut coal mine Project Environmental Impact Statement*, prepared by Umwelt (Australia) Pty Limited, dated August 2016, submitted with the application for consent for the development for SSD-7142 dated August 2016 including the Applicant's response to submissions, the Applicant's response to the Independent Planning Commission's review and the additional information responses provided by the Applicant in support of the application dated 20 September 2017, 6 November 2017, 5 December 2017, 11 October 2018, 17 October 2018, 12 April 2019, 14 April 2019 and 27 May 2019
- Modification application DA 305-7-2003 MOD 17 and accompanying documents titled *South Bates Extension Modification Environmental Assessment*, dated March 2017, and associated Response to Submissions (Parts A and B) dated June and September 2017 (Mod 17)
- Environment Protection Licence (EPL) 529

### 8.3 Management Plans, Programs and Strategies

- WCPL Biodiversity Management Plan (WA-ENV-MNP-506)
- WCPL Environmental Management Strategy (WA-ENV-MNP-501)
- WCPL Water Management Plan
- WCPL Groundwater Management Plan (WA-ENV-MNP-509.1)
- WCPL Surface Water Management Plan (WA-ENV-MNP-509.2)
- WCPL Site Water Balance (WA-ENV-MNP-509.5)
- WCPL Erosion and Sediment Control Plan (WA-ENV-MNP-509.3)
- WCPL Surface and Groundwater Response Plan (WA-ENV-MNP-509.4)

- WCPL Mining Operations Plan (MOP)
- WCPL, undated. Diversion Construction Program
- WCPL, 2007. North Wambo Creek Diversion (NWCD) Plan
- WCPL, 2008. North Wambo Creek Subsidence Response Strategy
- WCPL, 2013. North Wambo Creek Diversion Stage 3 Remediation and Monitoring Program, 28 June 2013
- WCPL, 2015. North Wambo Creek Diversion Inspection and Action Plan (July 2015)

## 8.4 Reports

- AECOM, 2018. Report on Flow Events along North Wambo Creek, South Wambo and Stoney Creeks for the period 1 February 2017 to 31 January 2018
- Alluvium, 2018. North Wambo Creek baseline assessment geomorphic context statement by Alluvium Consulting for Wambo Coal Pty Ltd, February 2018
- Cumberland Plains Seeds, 2019 NWCD Revegetation Management Plan. Report prepared for Soil Conservation Service.
- Cunningham et al., undated. Systems used to classify rural lands in New South Wales
- FloraSearch, 2015. South Bates (Wambo Seam) Underground Mine Modification Environmental Assessment – Flora Assessment. Report prepared for Wambo Coal Pty Limited.
- FloraSearch, 2016. South Wambo Underground Mine Modification – Flora Assessment. Prepared for Wambo Coal Pty Ltd. March 2016.
- FloraSearch, 2017. South Bates Extension Modification – Flora Assessment. Prepared for Wambo Coal Pty Ltd. January 2017.
- Geoterra, 2005. United Collieries Pty Ltd Surface and Groundwater Monitoring to December 31 2004.
- Gilbert and Associates, 2003. Wambo Development Project Surface Water Impact Assessment.
- Gilbert and Associates Pty Ltd, 2007. North Wambo Creek Diversion Design Report prepared for Wambo Coal Pty Ltd, Sep-07, Report ref: J0207-7-rgd.doc.
- Groundwater Imaging, 2012. A Transient Electromagnetic Investigation of the Extent of the Wollombi Brook Alluvium at the Wambo Coal Mine Site
- Hansen Bailey, 2018a. Wambo Coal Mine and Rail Loop Independent Environmental Audit Report, prepared by Hansen Bailey September 2018 for Wambo Coal Mine Pty Ltd.
- Hansen Bailey, 2018b. Wambo Coal Mine Independent Environmental Audit Additional Information
- Heritage Computing, 2012. North Wambo Underground Mine Modification Environmental Assessment: Appendix B Groundwater Assessment.

- HLA-Envirosciences Pty Ltd, 2007. North Wambo Creek Diversion Rehabilitation Plan, 5 September 2007 Resource Strategies, 2006. Wambo Coal Mine Modification Statement of Environmental Effects, Wambo Coal Pty Ltd, September 2006
- Soil Conservation Service 2019. North Wambo Creek Diversion Condition Assessment and Remediation Proposal Stage 1 Works 2020
- Soil Conservation Service 2019. North Wambo Creek Diversion Condition Assessment and Remediation Proposal Stage 2 Works 2021
- SLR North Wambo Creek Groundwater Modelling Report (draft) 2020. Prepared for Wambo Coal

## 8.5 Other

- NSW Department of Mineral Resources, 1993. Hunter Coalfield Regional Geology 1:100,000 map, Edition 2
- Tongway, D.J. and Hingley, N.L 2004. Landscape Function Analysis, Procedures for monitoring and assessing landscapes

# **APPENDIX A CORRESPONDENCE**

Regulator Comments received on Update to NWCD MP V1 (2019)

Regulator	Comment/Recommendation	WCPL Response
DPIE Water Group (Natural Resources Access Regulator) 4 July 2019	<p>Recommendation 1</p> <p>The Management Plan should be updated to address the performance criteria to demonstrate effective conformance to conditions 31(b), 31(c), 31(e), 31(f), 31(g), 35(b), 35(g) of the development consent.</p>	<p>These conditions relate to the previous version of DA305-7-2003. Modification 16, approved 29 August 2019, no longer contains this requirement. Conditions relevant to DA305-7-2003 (Modification 16) and where the conditions are addressed in this document are shown in <b>Table 1 (Section 1.4.1)</b>.</p>
	<p>Recommendation 2</p> <p>The Management Plan as per Schedule 4 Condition 31(c) should be updated to provide prescriptive detail articulating the process for measuring stream flow and alluvial aquifer losses associated with the stream diversion against nominated alluvial and/or stream flow performance measures positioned downstream of the open cut.</p>	<p>A detailed analysis of hydrology based on historic gauging information in association with more in depth groundwater analysis has developed further relationships between the two and provided direction for monitoring and analysis into the future with data from an expanded monitoring program.</p> <p>The flow event in February 2020 was the first event with adequate data (refer <b>Section 2.3</b>).</p>
	<p>Recommendation 3</p> <p>The Plan infers the hardrock base of the creek will sufficiently self seal subsidence-related hydraulic fracturing thereby limiting stream losses. A staged contingency plan is required to account for water losses in the event that the performance measures listed under Schedule 4 Condition 31 are not achieved within an acceptable timeframe.</p>	<p>Accounting for water losses upstream of the diversion by addressing Recommendation 2 has provided a much improved understanding of what flow can be expected to enter the diversion. Losses to subsidence related cracks in the diversion can be framed in that context. Flow events, with associated sediment transport are known at many longwall mining operations to reduce the hydraulic conductivity of subsidence cracks in bedrock (as is present in the base of the diversion) to a similar order of magnitude of natural fractures in the bedrock.</p>
	<p>Recommendation 4</p> <p>Provide additional information clarifying changes in hydrologic behaviour in North Wambo Creek through the diversion cutting. This must analyse any alteration in hydrographs from upstream to downstream of the diversion cutting. This must be delivered within three months of approval of the remediation plans to the North Wambo Creek Diversion Plan.</p>	<p>Addressed through the analysis for Recommendation 2 (refer <b>Section 2.3</b>)</p>
	<p>Explanatory Comment 1</p> <p><u>Hydrogeology</u></p> <p>Schedule 4 Condition 31(c) states:</p> <p>“The Plan must include the detailed design of the system that would return intercepted ground water to the alluvial aquifer downstream of the open cut.”</p> <p>Review of the Wambo Coal Annual Reports and Water Management Plan identifies that the existing alluvial monitoring bores downstream of the NWCD have gone dry or in other cases presented declining trends prior to being destroyed. Loss of recharge to the alluvial aquifer was evident. These bores were subsequently removed from Wambo Coal’s Trigger Action and Response Plan (TARP) without activation of any restoration works.</p>	<p>This condition relates to the previous version of DA305-7-2003. Modification 16, approved 29 August 2019, no longer contains this condition. Conditions relevant to DA305-7-2003 (Modification 16) are shown in <b>Table 1 (Section 1.4.1)</b>.</p>

Regulator	Comment/Recommendation	WCPL Response
	<p>Further detail is required to demonstrate how the proposed drilling program within an already impacted aquifer leads to returning intercepted groundwater, particularly if nominated reference TARP bores are to be removed once an impact is evident. As currently presented in the report, the proposed drilling work and monitoring does not appear sufficient to fulfil the conditional requirement and further detail is required prior to approval.</p> <p>Explanatory Comment 2  <u>Ecohydrology</u>  The diversion channel performance is not considered successful. Ongoing intervention is required to maintain the channel with similar bed widths and batter toe levels. The report does not provide sediment transport information.</p> <p>No revegetation seems to have occurred downstream of Point 10 of Figure 4 of the North Wambo Creek Diversion Management Plan. Where vegetation is present, it is widely scattered, and covers less than 10% of bank length in any reach. Vegetation species have not been listed in s 3.3 (Revegetation Strategy) of the Diversion Management Plan, though two species – <i>Casuarina cunninghamia</i> and <i>Angophora floribunda</i> – are identified for the strategy. Appropriate density and reach proportion of established vegetation along the diversion channel is required to achieve the stability outcome identified in the North Wambo Creek Diversion Management Plan.</p> <p>Condition 35(b) and 35(f) of Schedule 4 of the consolidated development consent requires Wambo Coal Mine to design and implement measures to mitigate reduction in surface flows and throughflows reporting to the final gauge site on North Wambo Creek above its junction with Wollombi Brook. The mitigation measures do not address these conditions. No information is presented to identify any impact caused by reduction in baseflows, pooling or saturation thickness in the associated alluvium.</p>	<p>Rehabilitation actions in the form of soil improvement, overland flow erosion management and revegetation are being incrementally implemented from downstream to upstream in the diversion over a number of years, having commenced in 2016 following initial review of performance by Alluvium in 2015 (refer to <b>Table 12 (Section 3.4.1)</b>).</p>
DPIE - Resources Regulator	<p>4.1 Performance and Completion Criteria should include success criteria for performance of revegetation works (for example, species diversity, species establishment).</p> <p>Moreover, section 4.3 Trigger Action Response Plans should be updated to include trigger levels for vegetation reestablishment</p>	<p>Performance and completion criteria are to be developed with a better informed understanding of the likely surface hydrologic regime of the diversion with monitoring data collected over the next 5-10 years. Trigger levels for vegetation re-establishment will be established and included in future revisions to this plan.</p>



## Previous regulator comments and where they have been addressed

Date	Regulator	Requirements	Where addressed in this Plan
14 April 2008	DPIE (formerly DoP)	<p>1. The SWMP must be updated to include at least two additional surface monitoring sites within the area of the North Wambo Creek Diversion footprint to replace those to be discontinued in the old North Wambo Creek footprint i.e. SW27 &amp; SW32 have been replaced by SW41, SW47 and SW48.</p> <p>2. The company must comply with the requirements of the Department of Water and Energy (DWE) and the Department of Primary Industries (DPI) as outlined in the attached letters to the company ....</p>	<b>Section 4.2</b> (see also SWMP)
31 March 2008	RR (formerly DPI)	<p>DPI requires additional matters to be addressed in the Rehabilitation Plan:</p> <ul style="list-style-type: none"> <li>Assessment of weeds and a weed control/eradication program.</li> <li>Use of large woody debris for habitat creation and stability design of diversion banks and bed.</li> <li>Implementation of supplementary control protocols for mining activities within the diversion area, vehicle and equipment access, signage of stockpiles, revegetation areas, monitoring and transect areas.</li> </ul>	<p>Addressed in original NWCD Plan</p> <p><b>Section 3.4</b> includes management strategies and actions for ongoing maintenance and rehabilitation of the NWCD</p>
		<p>DPI also required:</p> <ul style="list-style-type: none"> <li>Improved specification of success criteria and a systematic review during the Stage 1 works program.</li> <li>Supplementary specifications on project management and a gant chart showing activities for Stage 1 and 2 works.</li> <li>As-executed reports and survey drawings to be provided as an annexure to the MOP.</li> </ul>	<p><b>Section 4.1</b> includes revised criteria</p> <p>N/A to this Plan</p> <p>N/A to this Plan</p>
14 April 2008	DPI-Water (formerly DWE)	<p>DWE grants approval to the detailed design plans for the constructed diversion channel, subject to the following;</p> <ul style="list-style-type: none"> <li>Monitoring of discharge flows, and calculation of bankfull discharge capacities and velocities along the channel shall occur at the first discharge event along the diversion channel, and then thereafter as directed by the DWE;</li> <li>Comparative performance with agreed reaches upstream and downstream of the diversion shall occur, together with agreed stable reaches of control catchments, as approved by DWE;</li> <li>Reporting on performance of the diversion channel shall occur annually (in AEMR).</li> </ul>	<p><b>Section 4.2</b></p> <p><b>Section 4.2</b></p> <p><b>Section 5.1.1</b></p>
1 July 2013	DPIE	<p>NWCD Stage 3 Remediation and Monitoring Program</p> <p>The Director-General has approved open cut mining through the original creek line as described in Condition 28 Schedule 3 with the following conditions:</p> <ul style="list-style-type: none"> <li>The Program, as provided to the Department on the 28<sup>th</sup> June 2013, is implemented in full;</li> <li>The Program is to be implemented on a continual basis, 5 days a week and weather depending, until completed.</li> </ul>	<b>Section 3.4</b>

## **NWCD Plan approval – 14 April 2008**

17/04 2008 THU 16:36 FAX +61 2 MDA

001/005



NSW GOVERNMENT  
**Department of Planning**

Ms Sarah Bailey  
Environment and Community Manager  
Wambo Coal Pty Limited  
PMB 1  
SINGLETON NSW 2330

Contact: Rohan Tayler  
Phone: 02 9228 6465  
Fax: 02 9228 6466  
Email: [rohan.tayler@planning.nsw.gov.au](mailto:rohan.tayler@planning.nsw.gov.au)  
Our ref: S02/02197  
Your ref:

Dear Ms Bailey,

### **Re: North Wambo Creek Diversion Plan**

The Department has completed its review of the North Wambo Creek Diversion Plan in consultation with other relevant agencies, and I wish to advise you that it is generally satisfied that the plan fulfils the requirements of conditions 30 and 31 of Schedule 4 to the Wambo development consent (DA 305-7-2003). Consequently, the Director-General has approved the North Wambo Creek Diversion Plan, subject to the following conditions:

- the Surface Water Monitoring Program must be updated to include at least two additional surface monitoring sites within the area of the North Wambo Creek Diversion footprint to replace those to be discontinued in the old North Wambo Creek footprint (SW27 and SW32); and
- the company must comply with the requirements of the Department of Water and Energy and the Department of Primary Industries as outlined in the attached letters to the company.

It would be appreciated if you would forward the Department a copy of the final diversion plan once the conditions listed above have been addressed. Please also note that progress on the construction and monitoring of the creek diversion must be reported in the mine's Annual Environmental Management Report.

If you wish to discuss these matters further please contact Rohan Tayler on 9228 6465.

Yours sincerely

A handwritten signature in black ink that reads 'D Kitto 14/4/08'.

David Kitto  
**A/Executive Director**  
**Major Project Assessment**  
as Delegate for the Director-General

Department of Planning, 23-33 Bridge Street (GPO Box 39), Sydney, NSW 2001  
Website [www.planning.nsw.gov.au](http://www.planning.nsw.gov.au)



NSW DEPARTMENT OF  
PRIMARY INDUSTRIES

Now incorporating Department of Mineral Resources  
ABN 51 73 412 4190-003

31 March 2008

File Ref: L93/0257

General Manager  
Wambo Mine  
PMB 1  
SINGLETON NSW 2330

**ATTENTION:** Sarah Bailey – Environmental Specialist

Dear Sir,

#### **NORTH WAMBO CREEK DIVERSION**

I conducted an annual environmental review at Wambo on 11 November 2007. The purpose of the inspection was to review compliance with environmental requirements of relevant approval instruments including the Mining Lease, Mining Operation Plan (MOP) and Annual Environmental Management Report (AEMR).

At the mine meeting I provided review discussion and comment on various component plans of the Site Water Management Plan pursuant to consultation requirements of Condition 30 of DA 305-7-2003 (as modified);

- Site water balance
- SWMP
- ESCP
- SGWRP

These documents were generally satisfactory requiring generally additional notification in protocols for events and TARPs to DPI, and for the ESCP further information on vegetation cover procedures (seeding, hydro mulching, jute meshing and armouring) and for check validation within the Surface Disturbance Procedure. I understand the plans have been amended accordingly.

At the meeting I requested and Wambo provided status reports on the design for the North Wambo Creek Diversion for DPI review and comment;

- 1) North Wambo Creek Diversion Rehabilitation Plan, by HLA-Envirosciences, September 2007,
- 2) North Wambo Creek Diversion Design Report, by Gilbert and Associates, September 2007,
- 3) North Wambo Creek Opencut Diversion Channel General Specification, Alan Watson Associates, September 2007.

These documents have been reviewed and the following comments are provided according to the terms of Wambo's development consent (DA 305-7-2003 as modified) consultation requirements.

**North Wambo Creek Diversion Plan Conditions 26 to 28, and 30 to 31:**

DPI requires additional matters to be addressed in the Rehabilitation Plan 1) above;

- Section 3.1 - Site Preparation to include assessment of weeds and a weed control / eradication program by approved spraying and/or grubbing. This is to enhance germination of the revegetation works.
- Section 3.2 - Large woody debris is to be used for habitat creation and for stability design of diversion banks and bed. Wambo is to use large trunks and bowls of trees prestriped in the open cut operations for this purpose and assign management procedures for the evaluation, select handling, stockpiling and placement of large prestrip vegetation for the diversion works.
- Section 3.5 – Ecological performance's visual monitoring program should be supplemented by Wambo control protocols for any mining purpose activity within the diversion area; vehicle and equipment access, signage of material stockpile areas, revegetation areas, monitoring and transect areas.

The demonstration (referred to in Condition 28, and in Condition 31 e, f, g) of successful operation of the diversion prior to Stage 2 works will subsequently require improved specification of hydrological, ecological, geomorphic and water quality success criteria than is currently documented in 1) and 2) above. DPI recommends that Wambo facilitates a systematic review, in consultation inspections with DPI and DWE officers, during the Stage 1 works program.

It is assumed that the diversion plan comprises the combination of the reports 1) to 3) above. It is apparent however that these reports need integration through systematic project management. DPI subsequently will require supplementary specification by Wambo of;

- the diversion project's management (allocation of responsibilities, roles and contacts for technical / quality control supervision, integration with Wambo mine management),
- a gant chart of the diversion project's Stage 1 and Stage 2 activity (integrating; earthwork operations, rehabilitation and revegetation operations, inspection and monitoring program, agency consultation timelines).

DPI will require the as-executed report and survey drawings of the North Wambo Creek diversion (referred to in Condition 27) Stages 1 and 2 to be provided as an annexure to Wambo's MOP documentation.

The DPI concludes that the reports provided to date by Wambo are adequate to address consultation requirements for the design phase, however according to these review comments above further documentation and consultation with key agencies will be required during the operations and monitoring phases of the diversion project.

For clarification or further information please contact me at the DPI Maitland Office on (02)49316705.

Yours faithfully,

**Greg Summerhayes**  
**Principal Environmental Officer**  
**Environmental Sustainability Division**

Cc. Colin Phillips, DOP and Fergus Hancock, DWE

Mineral Resources - Environmental Sustainability Branch  
PO Box 51  
SINGLETON, NSW 2330 Australia  
C:\Temp\XP\Gp\Wise\0803\Wambo ck divs.doc Page 2 of 3



NSW Government

**DEPARTMENT OF WATER AND ENERGY**

Contact: Fergus Hancock  
Phone: (02) 4904 2532  
Fax: (02) 4904 2503  
Email: [Fergus.Hancock@dnr.nsw.gov.au](mailto:Fergus.Hancock@dnr.nsw.gov.au)

File: Detail\_design\_approval\_151107.doc

~~Jeff Hanlon  
Environmental Manager  
Wambo Coal Mines  
PMB 1  
Singleton NSW 2330~~

~~15 November 2007~~

Dear Mr Hanlon

**Subject: Detailed design approval – North Wambo Creek diversion 20SL61690**

The Department of Water and Energy (DWE) has completed its assessment of the detailed design plans with regard to the approved diversion of North Wambo Creek by Peabody Wambo Coal. DWE confirms the discussion held on 15 November 2007, which included:

- Confirmation that the 1:2 year storm event modelled discharge approximates bankfull discharge, which was raised as a concern in DWE's previous correspondence
- Explanation of the post-construction armouring of high energy zones in the channel
- Protection/armouring of inlet and outlet works to the existing North Wambo Creek channel
- Armouring or other protective measures to be incorporated into high energy zones of the constructed channel
- Performance measures to be incorporated into the monitoring programme

DWE grants approval to the detailed design plans for the constructed diversion channel, subject to the following:

- Long profile gradients and channel cross sections shall be constructed in accordance with design plans submitted to DWE
- Armouring protection works shall be incorporated into the inlet and outlet of the channel, at design sizes sufficient to resist scour and dislodgement under design discharge conditions
- Survey plans shall be submitted for the as-executed survey, including identification of sites requiring rock or other protection to bed and banks of the diversion channel
- Stage 2 works shall include additional armouring or other protective works, with revegetation, to prevent scour or erosion damaging the channel
- Revegetation, using suitable native species as approved by DWE, shall commence on completion of the construction of the channel

Major Projects, Mine Assessments and Planning Branch Level 3 26 Honeysuckle Drive Newcastle PO Box 2213 Dangar 2309  
Telephone (02) 4904 2500 Facsimile (02) 4904 2503 Website [naturalresources.nsw.gov.au](http://naturalresources.nsw.gov.au)

2

- Monitoring of discharge flows, and calculation of bankfull discharge capacities and velocities along the channel shall occur at each discharge event along the channel for the first five years of the diversion, and then thereafter as directed by DWE
- Comparative performance with agreed reaches upstream and downstream of the diversion shall occur, together with agreed stable reaches of control catchments, as approved by DWE
- Reporting on performance of the diversion channel shall occur annually, and after each discharge event, as agreed by DWE
- The finalised diversion channel shall be incorporated into the final landform plan for the Wambo mine site, as agreed between the Department of Primary Industries and DWE
- The as-executed report shall include channel bankfull capacity and hydraulic radius figures, and explanation for the size and grade of material used to stabilise the diversion channel prior to vegetation establishment
- Ongoing reporting of the stability of the diversion channel, and vegetation establishment, shall occur to DWE

DWE requires these measures to be incorporated into the diversion management plan required under conditions 11 and 12 of licence 20SL61690.

Should you require any clarification of the above, please contact Fergus Hancock on the above number.

Yours sincerely

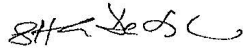

Hemantha DeSilva  
Senior Licensing Officer

## Approval to mine through original creek line – 1 July 2013



Peter Baker  
General Manager  
Wambo Coal Pty Limited  
PMB 1  
SINGLETON NSW 2330

Contact: Scott Brooks  
Phone: 6575 3401  
Fax: 6575 3415  
Email: [scott\\_brooks@planning.nsw.gov.au](mailto:scott_brooks@planning.nsw.gov.au)  
Our ref:

28 June 2013

Dear Peter

### **Wambo Coal Mine (DA 305-7-2003) North Wambo Creek Diversion Stage 3**

On 5 February 2013 the Division of Resources and Energy and our Department held a joint Annual Environmental Management Review (AEMR) inspection. As a part of this we inspected the recently completed North Wambo Creek Diversion (NWCD)

At the inspection, concern was raised over the condition of the recently completed Stage 3 NWCD.

Following this inspection there has been numerous correspondence between Wambo Coal and our Department. Further there has been considerable rehabilitation work undertaken on the NWCD Stage 3.

On the 28<sup>th</sup> June the final version of the Remediation and Monitoring Program (Program) was submitted to the Department. This Program has been reviewed by Neil McElhinney from DRE and Chris Gipple from Fluvial Systems. Both parties advised they were satisfied by the Program and Neil advised we could approve Condition 28 of the Wambo Consent.

Condition 28 Schedule 4 requires:

**28. Prior to destroying the original creek line by open cut mining, the Applicant shall demonstrate that the relevant stage of the North Wambo Creek Diversion is operating successfully from a hydrological and biological point of view to the satisfaction of DRE and the Director-General.**

*Note: This condition does not apply to the temporary North Wambo Creek Bypass.*

As stated above, DRE have advised they are satisfied with the current condition of the NWCD stage 3 providing the Program is implemented in full.

I advise that the Director General has approved open cut mining through the original creek line as described in Condition 28 Schedule 3 with the following conditions:

1. The Program, as provided to the Department on the 28<sup>th</sup> June 2013, is implemented in full;
2. The Program is to be implemented on a continual basis, 5 days a week and weather depending, until completed.

Singleton Office: P.O. Box 3145, Suite 14, Level 1, 1 Civic Avenue Singleton NSW 2330  
Website: [www.planning.nsw.gov.au](http://www.planning.nsw.gov.au)

Please note that the Department's approval of the open cut mining operations through the original creek line of North Wambo Creek is dependent upon the implementation of the Remediation and Monitoring Program. Should any adverse consequence arise which may compromise the integrity of the project approval, the Department may consider regulatory action under the provisions of the *Environmental Planning and Assessment Act 1979*.

Should you need to discuss the above, please contact me on 6575 3401 or email to [scott.brooks@planning.nsw.gov.au](mailto:scott.brooks@planning.nsw.gov.au).

Yours sincerely

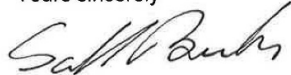

Scott Brooks

**Team Leader Compliance, Singleton**  
As Nominee of the Director General

1-7-2013



## **APPENDIX B NWCD MP COMMITMENTS**

Document	Section	Commitment	Timing
NWCD plan	Original 2008	<p>Approved in 2008, subject to additional monitoring and reporting requirements.  North Wambo Creek Diversion Plan is found within the Site Water Management Plan  Appendix B - NWCD Rehabilitation Plan requires:</p> <ul style="list-style-type: none"> <li>- A tree/grass/sedge mix is to be dispersed over the banks and base of the low flow channel as defined in Table 1</li> <li>- Following soil preparation the Floodplain domain above the Low Flow Channel and tributary channels are to be direct seeded. Seeding is to occur via a broadcast spinner, or by hand were the spinner is not suitable. Harrowing is required directly after seed dispersal. Species breakdown is as per Table 2.</li> <li>- 50mm tube stock is to be selectively planted in order to assist in the stability of areas at risk to erosion during high flow events.</li> <li>- Species chosen should be designed to provide strata composition of 60% overstorey; 20% middle storey and 20% understorey.</li> <li>- Planting densities should be no less than 400 stems per hectare.</li> <li>- Ten transects will be established along the length of the creek diversion, each transect will be clearly marked and GPS data collected.</li> <li>- Visual monitoring will take place at each of the ten transects</li> <li>- A weighted field sheet is to be used during the survey to assess the ecological performance and stability of the revegetated areas, and include; <ul style="list-style-type: none"> <li>• Vegetation Species and Site Sustainability</li> <li>• Assessment of Undesirable Characteristics</li> <li>• Landform and Geophysical Processes</li> <li>• Available Habitat</li> </ul> </li> <li>- Visual Monitoring and LFA Monitoring will be conducted on and annual bases in Spring.</li> </ul> <p>Appendix C – NWCD Construction Program</p> <ul style="list-style-type: none"> <li>- A highwall bund will be built to the east of the diversion.</li> <li>- The diversion will be monitored in the same way as all other rehabilitated areas of the mine. As with other rehabilitation on site, monitoring will identify success of the work or areas which may require remediation work.</li> <li>- Until the mine sites rehabilitation has been proved successful and has been approved by the relevant authority, all runoff from those surfaces will be captured and added to the site water system, not NWCD.</li> </ul>	Incorporated into the Mining Operations (MOP)
MOP	2.2.3.6	<p>In 2018, Wambo Coal, in consultation with the NSW Soil Conservation Service will prepare and commence implementation of a detailed 5 Year NCWD Rehabilitation and Maintenance Plan. The Plan will be developed in consultation with DRG.</p> <p>Rehabilitation maintenance works will be undertaken annually throughout the MOP term, including:</p> <ul style="list-style-type: none"> <li>- Weed management (particular focus on Galenia puecens) to control this noxious weed;</li> <li>- Repair areas of erosion;</li> <li>- Re-seeding with selected native pasture and tree species;</li> </ul>	2019-2020

Document	Section	Commitment	Timing
		<ul style="list-style-type: none"> <li>- Revegetation trials with native grass species in selective areas of the diversion to assist in controlling weeds; and</li> <li>- Collection of native grass seeds within pasture areas on adjacent WCPL owned pasture lands.</li> </ul>	
2017 IEA		North Wambo Creek Diversion Plan not yet revised to include the required section on mechanism for the return of intercepted groundwater (previous Audit non-compliance)	No longer required by Development Consent
	6.7.3	The current diversion management and monitoring objectives, strategies and commitments are contained in several documents. Consolidated commitments into a single management plan	Complete in draft – this Plan
	Table 9	Rehabilitation of subsided areas is required in accordance with an Extraction Plan, including repairing surface subsidence cracks and undertaking subsidence remediation where necessary in areas where the diversion has been subsided.	Ongoing (as detailed in Appendix C)
	Appendix F Independent Environmental Audit  Additional Information (Ross Edwards) Section 3.1.2	<p><u>Downstream of longwall panel LW16</u> (i.e. currently subsided areas):</p> <ul style="list-style-type: none"> <li>- The reconstruction of all batter chutes in order to manage runoff draining over the diversion banks address rill and gully erosion issues;</li> <li>- Reconfiguration of the overbank bunding and drainage arrangement in order to prevent ponding at the top of the diversion banks and associated tunnel erosion;</li> <li>- The application of on-contour ripping (per 2015 diversion review recommendations) to all appropriate locations in Stage 3 diversion reach; and</li> <li>- Regrading of the existing drain to repair incision in the mid Stage 3 diversion reach.</li> </ul> <p><u>Upstream of longwall panel LW16</u> (i.e. including planned subsidence areas):</p> <ul style="list-style-type: none"> <li>- Actions to address existing erosion of diversion banks above and upstream of longwall panel LW 16 pillar, and any potential increase in erosion due to subsidence in these areas. Actions may include stabilisation above longwall panels LW 11 and LW12 and the area upstream of longwall panel LW 11.</li> <li>- Actions to address alluvial baseflow to the open cut mining area.</li> <li>- Subsidence crack management and monitoring in the diversion.</li> <li>- New batter chutes to be designed and installed above longwall panels LW11 to LW16 including both banks of the diversion above longwall panel LW13;</li> <li>- Regrading of the existing drain to repair incision in the upper Stage 3 diversion reach; and</li> <li>- A review of stream flow estimates and monitoring data for North Wambo Creek to refine the modelling predictions. These modelling predictions are used to as a diversion management tool.</li> </ul>	Ongoing (as detailed in Appendix C)
		North Wambo Creek Diversion Rehabilitation and Maintenance Plan be developed in 2018 in consultation with key stakeholders. The proposed scope of the plan includes consideration of the current diversion performance indicators and completion criteria, development of alternative performance indicators and completion criteria if necessary and detailed scheduling of diversion stabilisation and rehabilitation	2019

Document	Section	Commitment	Timing										
		works over a five year horizon. The proposed scope of the North Wambo Creek Diversion Rehabilitation and Maintenance Plan is currently limited to the reaches of the diversion and North Wambo Creek located downstream of longwall panel LW16. The proposed plan is to be implemented from 2018 onwards and reviewed in 2020.											
		<table border="1"> <thead> <tr> <th>Action</th> <th>Timing</th> </tr> </thead> <tbody> <tr> <td>Liaise with technical specialists and stakeholders to establish the scope specific erosion repair works to be undertaken in early 2019 as an interim management measure until the Diversion and Rehabilitation Plan is finalised. The following specific erosion repair works will be considered: <ul style="list-style-type: none"> <li>The reconstruction of all batter chutes in order to manage runoff draining over the diversion banks address rill and gully erosion issues;</li> <li>Reconfiguration of the overbank bunding and drainage arrangement in order to prevent ponding at the top of the diversion banks and associated tunnel erosion;</li> <li>The application of on-contour ripping (per 2015 diversion review recommendations) to all appropriate locations in Stage 3 diversion reach; and</li> <li>Regrading of the existing drain to repair incision in the mid Stage 3 diversion reach.</li> </ul> These measures should be included in the updated North Wambo Creek Management Plan.</td> <td>End 2018</td> </tr> <tr> <td>Undertake diversion inspections and implement rehabilitation maintenance works described in the MOP (refer to above in MOP commitments)</td> <td>End 2018</td> </tr> <tr> <td>Update the North Wambo Creek Management Plan. (refer to listed detail in Table on Page 10, IEA Appendix attached)</td> <td>Complete, this document</td> </tr> <tr> <td>Implement the updated North Wambo Creek Management Plan</td> <td>Ongoing</td> </tr> </tbody> </table>	Action	Timing	Liaise with technical specialists and stakeholders to establish the scope specific erosion repair works to be undertaken in early 2019 as an interim management measure until the Diversion and Rehabilitation Plan is finalised. The following specific erosion repair works will be considered: <ul style="list-style-type: none"> <li>The reconstruction of all batter chutes in order to manage runoff draining over the diversion banks address rill and gully erosion issues;</li> <li>Reconfiguration of the overbank bunding and drainage arrangement in order to prevent ponding at the top of the diversion banks and associated tunnel erosion;</li> <li>The application of on-contour ripping (per 2015 diversion review recommendations) to all appropriate locations in Stage 3 diversion reach; and</li> <li>Regrading of the existing drain to repair incision in the mid Stage 3 diversion reach.</li> </ul> These measures should be included in the updated North Wambo Creek Management Plan.	End 2018	Undertake diversion inspections and implement rehabilitation maintenance works described in the MOP (refer to above in MOP commitments)	End 2018	Update the North Wambo Creek Management Plan. (refer to listed detail in Table on Page 10, IEA Appendix attached)	Complete, this document	Implement the updated North Wambo Creek Management Plan	Ongoing	2019-2020
Action	Timing												
Liaise with technical specialists and stakeholders to establish the scope specific erosion repair works to be undertaken in early 2019 as an interim management measure until the Diversion and Rehabilitation Plan is finalised. The following specific erosion repair works will be considered: <ul style="list-style-type: none"> <li>The reconstruction of all batter chutes in order to manage runoff draining over the diversion banks address rill and gully erosion issues;</li> <li>Reconfiguration of the overbank bunding and drainage arrangement in order to prevent ponding at the top of the diversion banks and associated tunnel erosion;</li> <li>The application of on-contour ripping (per 2015 diversion review recommendations) to all appropriate locations in Stage 3 diversion reach; and</li> <li>Regrading of the existing drain to repair incision in the mid Stage 3 diversion reach.</li> </ul> These measures should be included in the updated North Wambo Creek Management Plan.	End 2018												
Undertake diversion inspections and implement rehabilitation maintenance works described in the MOP (refer to above in MOP commitments)	End 2018												
Update the North Wambo Creek Management Plan. (refer to listed detail in Table on Page 10, IEA Appendix attached)	Complete, this document												
Implement the updated North Wambo Creek Management Plan	Ongoing												
NWCD Management Plan (version 1) 2019	3.3	Identify areas suitable for establishment of riparian vegetation once the final landform is constructed and revegetate remaining areas with a species mix which includes both riparian and woodland species.	Ongoing										
	3.3	Revegetation required for the implementation of the 5 Year Rehabilitation and Maintenance Plan, detailed in Section 3.4.1, will be consistent with the Revegetation Strategy contained in the MOP and the North Wambo Creek Diversion Revegetation Management Plan (Cumberland Plains Seeds, 2019)	Ongoing										
	3.4.1	All works will be undertaken in accordance with the Detailed Rehabilitation Plan (Appendix C), which will be revised as required. Ongoing monitoring will continue to be undertaken in accordance with <b>Section 4.2</b> .	Ongoing										

Document	Section	Commitment	Timing
		Additional monitoring and inspections will be undertaken in accordance with site-specific Erosion and Sediment Control Plans or Surface Disturbance Permit requirements for on-ground works.	As required
		Performance will be reviewed annually against the performance criteria in <b>Section 4.1</b> and the 5YR RMP, with results reported in the Annual Review.	Annually
	3.4.1.1	The proposed works in <b>Table 12</b> include chute construction and repair, channel stability works and revegetation works. These works are also detailed further in Appendix C.	2019-2020
		A range of works will be undertaken each year including: <ul style="list-style-type: none"> <li>- Review of this plan to confirm there are no changes required to the plan;</li> <li>- Review of the works undertaken in the previous year to confirm whether there are any amendments or improvements which can be made to chute design or repairs;</li> <li>- Monitoring required to be undertaken as detailed in <b>Section 4.2</b>; and</li> <li>- Reporting of works undertaken during the year as detailed in <b>Section 5.1</b>.</li> </ul>	Annually
		Sites 1 and 5 (on <b>Figure 7</b> ) have been identified as areas of instability which require further assessment to identify appropriate management actions. This assessment will commence in 2019.	2019
	3.4.1.2	Establish the management framework and stakeholder consultation program (in 2019) for the ongoing management of the NWCD over the next five years.	2019
		Works to be undertaken as detailed in <b>Table 12)</b> - .	2020-2021 and beyond
	4.2	Monitoring data will be compared to the performance criteria detailed in <b>Section 4.1</b> . Unsatisfactory performance and follow up required will be recorded as part of the monitoring observations and as described in the Trigger Action Response Plans ( <b>Section 4.3</b> )	As required
		Diversion monitoring will be undertaken as summarised in <b>Table 17</b>	As required
	4.3	The North Wambo Creek Diversion Performance TARP implemented in the event that: <ul style="list-style-type: none"> <li>- Surface water monitoring of North Wambo Creek, for pH, EC and TSS, identifies water quality results exceeding the 80th Percentile Trigger Value, as identified in the SWMP after two consecutive sampling events; or</li> <li>- Monitoring of Landscape Function Analysis (LFA) of riparian areas in accordance with the Biodiversity Management Plan (2019) identifies a potential decline in creek stability, beyond natural fluctuations (<b>Section 4.3.2</b>); or</li> <li>- Subsidence impacts are observed which exceed the performance criteria (<b>Section 4.3.3</b>).</li> <li>- Two consecutive events require the initiation of the Level 1 response with three consecutive events requiring instigation of the Level 2 response.</li> </ul>	
	4.4	Environmental incidents that cause or have the potential to cause harm to the environment will be reported in accordance with <b>Section 5.1.2</b> .	As required

# **APPENDIX C DETAILED REHABILITATION PLAN**



**DESIGN REPORT:**

**North Wambo Creek Detailed Rehabilitation Plan**

April 2019

## Document history

### Revision:

Revision no.	01
Author/s	Jacob Dearlove Rohan Lucas Jason Carter
Checked	Rohan Lucas
Approved	Rohan Lucas

### Distribution:

Revision no.	01
Issue date	18 April 2019
Issued to	Nicole Dobbins

Description: Original issue

**Citation:** Alluvium (2019) North Wambo Creek Detailed Rehabilitation Plan. A report for Wambo Coal Pty Limited.

Ref: \\all-sbs\departments\Work\2019\0219016\_North\_Wambo\_Creek\_Detailed\_Action\_Plan\10\_Project\1\_Deliverables\0219016\_North Wambo Creek Detailed Rehabilitation Plan v1.0.docx



# Contents

<b>1</b>	<b>Introduction</b>	<b>3</b>
1.1	Background	3
1.2	Areas of interest	3
<b>2</b>	<b>Overland flow entry management</b>	<b>5</b>
2.1	Batter Chute Assessment	7
2.2	Batter chute design	14
<b>3</b>	<b>Channel stability works</b>	<b>16</b>
3.1	Identified Areas of instability and proposed works	16
<b>4</b>	<b>Ripping, soil amelioration and revegetation works</b>	<b>22</b>
4.1	Areas requiring works	22
4.2	Proposed rehabilitation methods	22
	Weed management	22
	Ripping	23
	Soil amelioration	23
<b>5</b>	<b>References</b>	<b>24</b>
	<b>Attachment A Design Drawings</b>	<b>25</b>
	<b>Attachment B Technical Specifications</b>	<b>27</b>

## Figures

Figure 1.	Extents of proposed North Wambo Creek detailed design works	4
Figure 2.	Location of existing batter chutes along both the downstream portion of NWCD and the portion over LW11-LW16	5
Figure 3.	Location of new and reconfigured batter chutes along both the downstream portion of NWCD and the portion over LW11-LW16	6
Figure 4.	NWCD overland flow path mapping using CatchSim	7
Figure 5.	Identified bank instabilities and recommended areas of stabilisation works	16
Figure 6.	Areas requiring ripping and soil amelioration works.	22

## Tables

Table 1.	Existing batter chute assessment	8
Table 2.	Design parameters and criteria adopted for detail design batter chutes	14
Table 3.	Predicted flows for flow paths over South Bates Extension post subsidence	14
Table 4.	Batter Chute specifications	15
Table 5.	Areas of Instabilities and recommended management actions	17

## Abbreviations

Alluvium	Alluvium Consulting Australia Pty Ltd
WCPL	Wambo Coal Pty Limited

# 1 Introduction

## 1.1 Background

Alluvium Consulting Australia (Alluvium) has been commissioned by Wambo Coal Pty Limited (WCPL) to develop a Detailed Action Plan (suitable for construction) following from previous work in providing responses to NSW DPE's requests following an independent environmental audit on the following:

1. An assessment of geomorphic function of the North Wambo Creek Diversion (NWCD) compared to an undisturbed reference reach section of North Wambo Creek; and
2. An action plan to include stabilisation and rehabilitation works for NWCD.

The work completed prior to this detailed action plan includes the delivery of the report "North Wambo Creek diversion – rehabilitation action plan" (Alluvium October 2018, updated April 2019), which provides a concept level diversion design and rehabilitation action plan. WCPL now wish to undertake on ground works, which requires that the concept design prepared previously be progressed to a detailed level, suitable for issuing for construction. This report details that design.

The "North Wambo Creek diversion – rehabilitation action plan" (Alluvium October 2018, updated April 2019), has also been updated to include a 5 year action plan.

## 1.2 Areas of interest

North Wambo Creek forms at the confluence of its two tributaries, Spring Creek and Chalkers Creek upstream of current mining (underground and open cut) operations at the base of slope of steep sandstone escarpment country. Further downstream in what was a broader valley with alluvial valley fill, North Wambo Creek has been subject to diversion around the open cut operations by construction of a new channel in several stages through footslope areas to the west of the original valley alignment. This diversion makes up approximately 5.8km of the remaining 7.3km before its confluence with Wollombi Brook.

The areas of interest for this Detailed Rehabilitation Plan are (see Figure 1):

- Re-forming overland flow entry management, both bunds and batter chutes in both the downstream portion of NWCD and the portion over LW11-LW16.
- Ripping, soil amelioration and vegetation establishment on upper surfaces, upper batters and the inset floodplain. In some areas this may require ripping of the sandstone. Temporary fencing may also be considered for plant establishment given the high grazing pressure from kangaroos.
  - Previous seeding campaigns with various species have been identified, monitoring of these areas will inform any further revegetation effort.
- Bank stability management in areas identified in the extraction plan for LW11-16 and LW17-20.

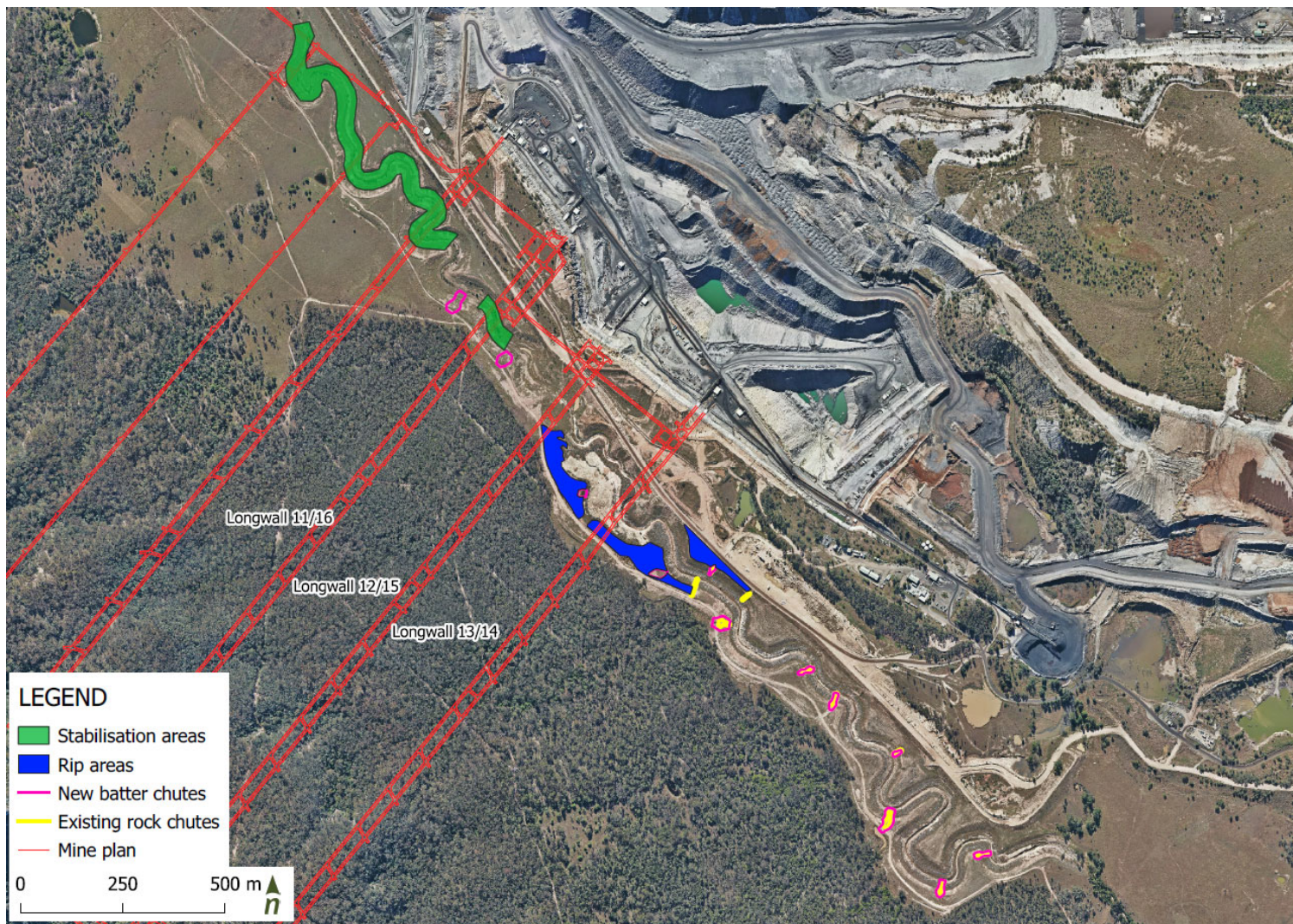

**Figure 1.** Extents of proposed North Wambo Creek detailed design works

## 2 Overland flow entry management

The NWCD channel alignment intercepts a number of minor tributaries and overland flow catchments originating in the hillslopes to the west of the diversion. There are also some small catchments on the eastern side (mining side) of the diversion channel requiring management.

To manage this surface water runoff a series of rock lined batter chutes with associated bunds at top of bank, aimed at intercepting and conveying surface water flows to the base of the diversion channel, have been constructed previously (refer Figure 2). In total there are eleven batter chutes along the NWCD. Monitoring of the diversion has revealed that these rock lined batter chutes have not performed to their design intent and have been damaged or bypassed by nearby pipe/tunnel erosion.

As part of the NWCD detailed action plan these batter chutes will be reconstructed with appropriate materials for the dispersive sub soils and moved to locations appropriate to the topography.

In addition to the repair/reconstructing of these existing batter chutes three new batter chutes will be constructed to manage the altered overland flow entry created by subsidence over LW11-LW16. Minor ancillary earthworks to ensure these chutes capture and convey all flow from the panels into the diversion without creating further rill/pipe/tunnel/gully erosion on the diversion batters will also be required. It should be noted that the batter drains have been designed to a detailed level, however fine detail regarding the reshaping of the area adjacent to the batter drains and diversion banks to ensure flows enter at the batter drain crests has been deferred to the construction stage. The new/reconfigured chute locations are shown in Figure 3.



**Figure 2.** Location of existing batter chutes along both the downstream portion of NWCD and the portion over LW11-LW16

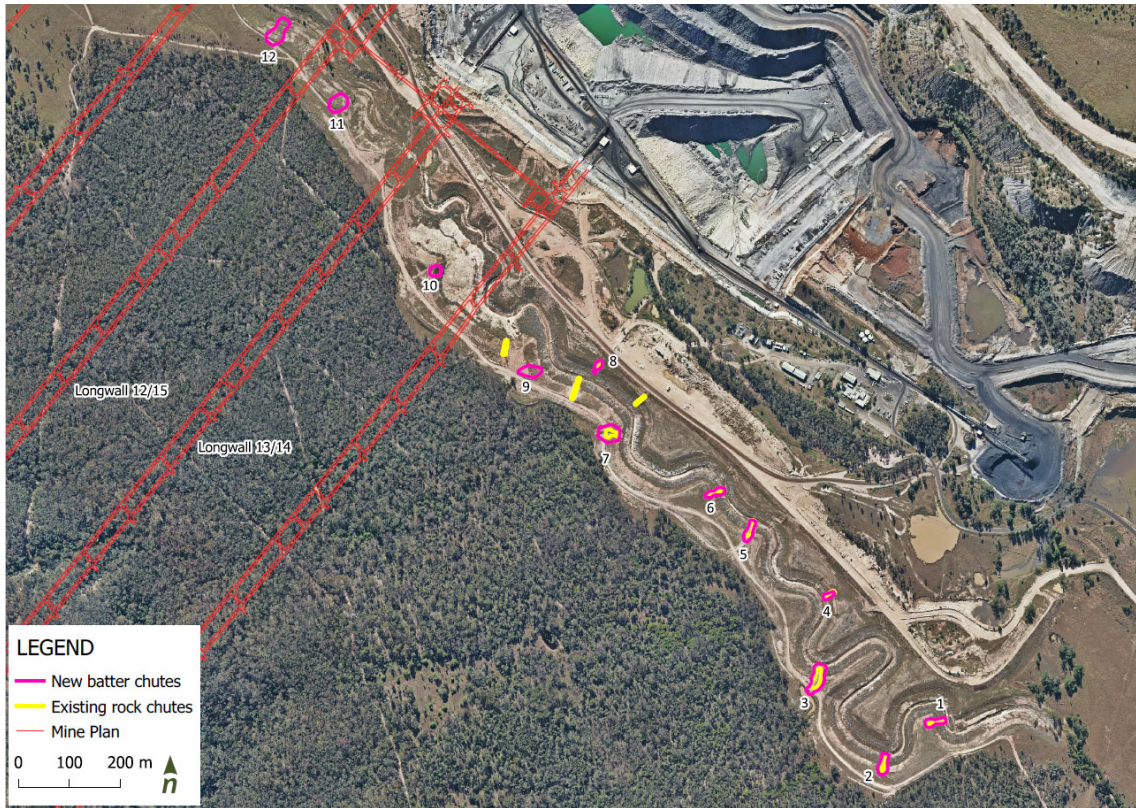

**Figure 3.** Location of new and reconfigured batter chutes along both the downstream portion of NWCD and the portion over LW11-LW16

## 2.1 Batter Chute Assessment

Assessment of the existing batter chutes has been completed using a combination of onsite inspection of the chutes and flow path mapping using the latest (post LW11-LW16 subsidence) survey data. As part of the assessment, the current issues, threats and risks of each batter chute has been identified as well as a summary of the management action and an order of priority for construction. New chutes are the highest priority then the repair of existing chutes based on area of catchment and those with the largest catchments to be treated first. Management actions are described in detail in section 2.2.

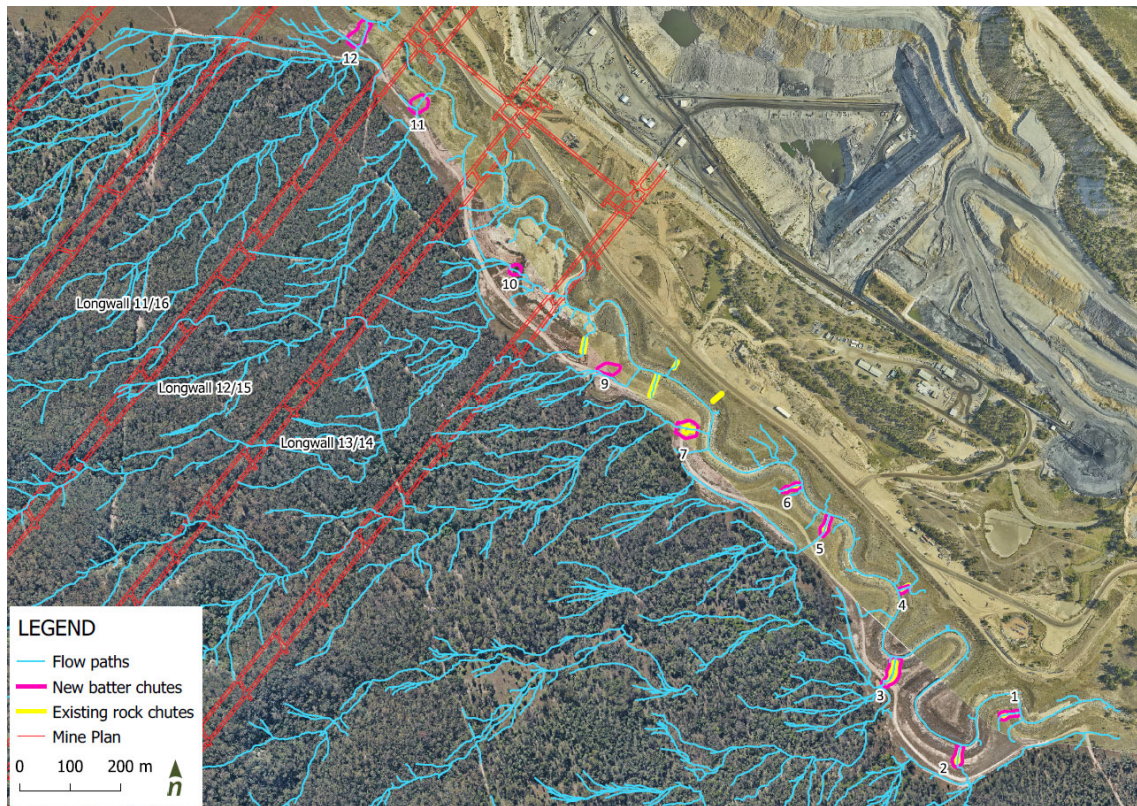



Figure 4. NWCD overland flow path mapping using CatchSim

**Table 1.** Batter chute assessment and priority order



Priority order and catchment area	Batter chute ID	Photo	Issue/threat/risk	Management Action
1 (50ha)	12	New chute - no photo	New chute to address change in flow path due to subsidence.	Construct new chute.
2 (43ha)	11		<p>Undermining of chute due to incorrect construction/materials.</p> <p>Rock chute sits proud of surrounding surface, preventing flows entering chute.</p> <p>Poorly graded and shaped rock mix used.</p> <p>Geotextile layer under rock causing piping plane failure.</p> <p>Ponding along top of bank causing Tunnel erosion.</p> <p>Road along top of bank with drain alongside causes ponding along top of bank – causing tunnelling.</p>	Catchment area contributing chute has decreased due to subsidence – possibility to direct flows from this catchment into nearby chute.



3 (36ha)	10		<p>Undermining of chute due to incorrect construction/materials.</p> <p>Rock chute sits proud of surrounding surface, preventing flows entering chute.</p> <p>Poorly graded and shaped rock mix used.</p> <p>Geotextile layer under rock causing piping plane failure.</p> <p>Ponding along top of bank causing Tunnel erosion.</p> <p>Road along top of bank with drain alongside causes ponding along top of bank – causing tunnelling.</p> <p>Catchsim flow path modelling shows that flowpaths have changed due to subsidence – rock chute in incorrect place.</p>	<p>Replace batter chute with properly designed new chute.</p> <p>Include granular filter layer.</p> <p>Use correctly graded rock mix.</p> <p>Extend rock beaching upstream to pond – acts as rock armoured spillway.</p> <p>Reconfigure area upstream of chute to direct flows down bund whilst preventing water from ponding within 10m of top of bank. Realign road and fill over existing road so that top of bank ties in with nearby raised bund of eastern side of existing road.</p> <p>Realign chute according to new flow paths.</p>
4 (5ha)	9	New chute - no photo	New chute to address change in flow path due to subsidence.	Construct new chute.

<p>5 (106ha)</p>	<p>3</p>		<p>Rock chute effectively acts as spillway from small pond.</p> <p>Undermining of chute due to incorrect construction/materials.</p> <p>Rock chute sits proud of surrounding surface, preventing flows entering chute.</p> <p>Poorly graded and shaped rock mix used.</p> <p>Geotextile layer under rock causing piping plane failure.</p> <p>Ponding along top of bank causing Tunnel erosion.</p>	<p>Reconstruct batter chute with:</p> <ul style="list-style-type: none"> <li>• granular filter layer instead of geofabric</li> <li>• correctly graded rock mix.</li> </ul> <p>Extend rock beaching upstream to pond – acts as rock armoured spillway.</p> <p>Reconfigure area upstream of chute to direct flows down bund whilst preventing water from ponding within 10m of top of bank.</p>
<p>6 (50ha)</p>	<p>7</p>		<p>Undermining of chute due to incorrect construction/materials.</p> <p>Rock chute sits proud of surrounding surface, preventing flows entering chute.</p> <p>Poorly graded and shaped rock mix used.</p> <p>Geotextile layer under rock causing piping plane failure.</p> <p>Ponding along top of bank causing Tunnel erosion.</p>	<p>Reconstruct batter chute with:</p> <ul style="list-style-type: none"> <li>• Lower crest</li> <li>• granular filter layer instead of geofabric</li> <li>• correctly graded rock mix.</li> </ul> <p>Reconfigure area upstream of chute to direct flows down bund whilst preventing water from ponding within 10m of top of bank.</p>

7 (11ha)	2		<p>Undermining of chute due to incorrect construction/materials.</p> <p>Rock chute sits proud of surrounding surface, preventing flows entering chute.</p> <p>Poorly graded and rounded rock mix used.</p> <p>Geotextile layer under rock causing preferential piping plane under rock.</p> <p>Ponding upstream of crest – tunnelling risk.</p>	<p>Reconstruct batter chute with:</p> <ul style="list-style-type: none"> <li>• Lower crest</li> <li>• granular filter layer instead of geofabric</li> <li>• correctly graded rock mix.</li> </ul> <p>Reconfigure area upstream of chute to direct flows down bund whilst preventing water from ponding within 10m of top of bank.</p>
8 (8.3ha)	5		<p>Risk of erosion upstream of chute due to lack of vegetation.</p> <p>Undermining of chute due to incorrect construction/materials.</p> <p>Rock chute sits proud of surrounding surface, preventing flows entering chute.</p> <p>Poorly graded and shaped rock mix used.</p> <p>Geotextile layer under rock causing piping plane failure.</p> <p>Ponding along top of bank causing Tunnel erosion.</p>	<p>Revegetation/rock beaching upstream of chute.</p> <p>Replace batter chute with properly designed new chute.</p> <p>Reconstruct batter chute with:</p> <ul style="list-style-type: none"> <li>• Lower crest</li> <li>• granular filter layer instead of geofabric</li> <li>• correctly graded rock mix.</li> </ul> <p>Reconfigure area upstream of chute to direct flows down bund whilst preventing water from ponding within 10m of top of</p>

				bank.
9 (5.4ha)	6		<p>Undermining of chute due to incorrect construction/materials.</p> <p>Rock chute sits proud of surrounding surface, preventing flows entering chute.</p> <p>Poorly graded and shaped rock mix used.</p> <p>Geotextile layer under rock causing piping plane failure.</p> <p>Ponding along top of bank causing Tunnel erosion.</p>	<p>Reconstruct batter chute with:</p> <ul style="list-style-type: none"> <li>• Lower crest</li> <li>• granular filter layer instead of geofabric</li> <li>• correctly graded rock mix.</li> </ul> <p>Reconfigure area upstream of chute to direct flows down bund whilst preventing water from ponding within 10m of top of bank.</p>
10 (1ha)	1		<p>Undermining of chute due to incorrect construction/materials.</p> <p>Rock chute sits proud of surrounding surface, preventing flows entering chute.</p> <p>Poorly graded and shaped rock mix used.</p> <p>Geotextile layer under rock causing piping plane failure.</p> <p>Ponding along top of bank causing Tunnel erosion.</p>	<p>Reconstruct batter chute with:</p> <ul style="list-style-type: none"> <li>• Lower crest</li> <li>• granular filter layer instead of geofabric</li> <li>• correctly graded rock mix.</li> </ul> <p>Reconfigure area upstream of chute to direct flows down bund whilst preventing water from ponding within 10m of top of bank.</p>

				
11 (1ha)	4	No Photos		
12 (1ha)	8			No works required – Catchsim flow mapping indicates chute redundant.

## 2.2 Batter chute design

The location for the batter chutes has been selected based on the updated flow path mapping and site visits. Batter chutes have been designed with the aid of the CHUTE software package. The parameters required for input to CHUTE for the design of the chutes are summarised below (Table 2).

**Table 2.** Design parameters and criteria adopted for detail design batter chutes

Parameter	Units	Adopted criteria
Rock angle of repose	degrees	42
Specific Gravity of rock		2.65
Factor of Safety		1.2

Streamflow estimates for each of the upstream contributing catchments for each chute were obtained using the Regional Flood Frequency Estimation Model (RFFEM). The RFFEM is a method developed by Dr Ataur Rahman and Dr Khaled Haddad from Western Sydney University for the draft 4<sup>th</sup> edition of Australian Rainfall and Runoff and is suitable for use in small, rural catchments. The flow estimates are summarised in Table 3.

**Table 3.** Predicted flows for flow paths over South Bates Extension post subsidence

Batter Chute	Catchment area (ha)	5% AEP/20year ARI (m <sup>3</sup> /s)
1	1	0.74
2	11	3.32
3	106.4	12.5
4	1	0.74
5	8.3	2.86
6	5.4	2.06
7	50	8.82
8	1	0.74
9	5	1.83
10	36	6.86
11	43	7.86
12	50	8.82

The following dimensions and quantity estimates have been determined for each of the Batter chutes (Table 4 **Error! Reference source not found.**). Note that some chutes comprise of two chutes in order to match the existing diversion bank profile which includes an upper batter, bench and lower batter.

**Table 4.** Batter Chute specifications

Parameter	Chute 1		Chute 2		Chute 3	Chute 4	Chute 5		Chute 6	Chute 7	Chute 8	Chute 9	Chute 10	Chute 11	Chute 12
	upper	lower	upper	lower			upper	lower							
<b>Chute length (m)</b>	15	8	20	5	48	21	20	6	31	37	26	44	17	35	43
<b>Chute Drop (m)</b>	3.0	1.5	4.0	1.0	4	2.5	3.5	1	5	7	5.2	8.5	3.3	7	8.5
<b>Chute Width (m)</b>	6	6	8	8	10	4	6	6	4	15	4	4	12	14	15
<b>Apron Length (m)</b>	17	1	15	2	2	2.5	16	2	9.5	2	1.5	2	4.5	4	13.5
<b>Apron Rise (m)</b>	-1	0	-0.5	0	0	0	-1	0	0	0	0.5	0	0	0	0
<b>Rock size, D50 (mm)</b>	300	300	400	400	450	450	400	400	400	450	300	450	450	450	450

The full design details are shown in the associated drawings and technical specifications in Attachments A and B.

### 3 Channel stability works

#### 3.1 Identified Areas of instability and proposed works

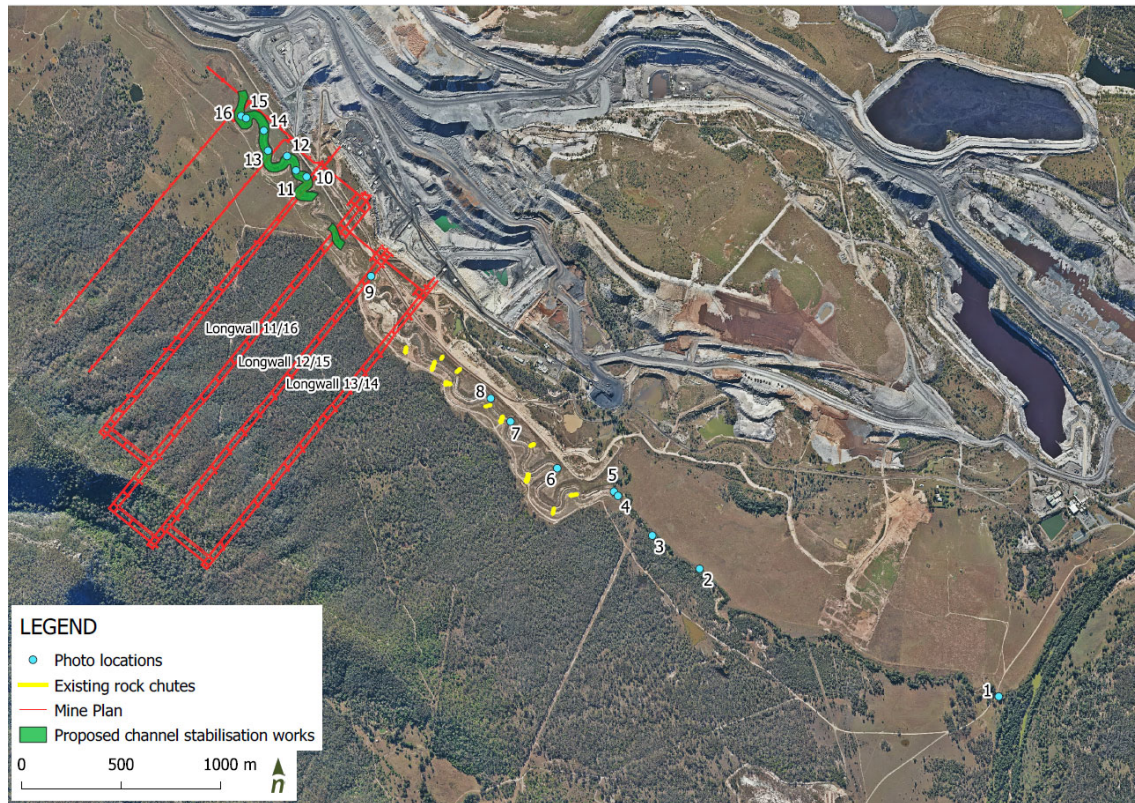

Identified areas of bank instabilities that aren't included as part of batter chute works or ripping and soil amelioration along with proposed works are shown in Figure 5 and Table 5.









**Figure 5.** Identified bank instabilities and recommended areas of stabilisation works











**Table 5.** Areas of Instabilities and recommended management actions

Site ID	Stage	Description	Photo	Issue/threat/risk	Management Action
01	Downstream Reach	Incision in downstream reach.		Loss of crossing, major sediment slug release by incision, unravelling of rock chute at downstream end of diversion.	Further assessment required.
02	Downstream Reach	Incision in downstream reach.		Loss of sediment.	Bedrock controls will prevent further migration.  Ongoing monitoring recommended – Annual inspections and survey of head cut to measure any significant changes.
03	Downstream Reach	Incision in downstream reach.		Loss of sediment.	Bedrock controls will prevent further migration.  Ongoing monitoring recommended – Annual inspections and survey of head cut to measure any significant changes.

04	Diversion - Stage 3	Rock chute tie in to downstream.		Durability of sandstone, long term increase in grade and erosive potential in downstream end of diversion, partial mitigation due to the downstream extent of diversion being largely in situ sandstone.	Include in ongoing monitoring program - Annual inspections to monitor any significant changes in stability.
05	Diversion - Stage 3	Rock chute.		Instabilities, undermining due to poor rock grading and poor embedment (no granular filter layer/sitting on bedrock).	Further assessment required however chute may need to be replaced (graded rock, filter layer, key in).
06	Diversion - Stage 3	Rock beaching works on outside bend of diversion channel.		durability of sandstone, long-term stability of rock beaching, undermining.	Include in ongoing monitoring program - Annual inspections to monitor any significant changes in stability.

07	Diversion - Stage 3	Erosion along toe.		Further channel erosion and loss of sediment.	Batter eroded banks back at 1V:4H from the toe, apply topsoil and revegetate.
08	Diversion - Stage 3	Gullying along bench caused from flows down possible batter chute.		Migration of head cut, loss of sediment.	Include in ongoing monitoring program – Annual inspections and survey of head cut to measure any significant changes.  Possible rock beaching required depending on underlying geology.
09	Diversion - Stage 3	Incision down to bedrock. Head cut migrating upstream.		Risk head cut will continue migrating upstream.	Include in ongoing monitoring program – Annual inspections and survey of head cut to measure any significant changes.  Progression of head cut limited by hard underlying geology (sandstone).

					
10	Diversion - Stage 2	Erosion along toe.		Risk of further bank erosion and loss of sediment.	Batter eroded banks back at 1V:4H from the toe, apply topsoil and revegetate.
11	Diversion - Stage 2	Erosion along toe.		Risk of further bank erosion and loss of sediment.	Batter eroded banks back at 1V:4H from the toe, apply topsoil and revegetate.
12	Diversion - Stage 2	Erosion along toe.		Risk of further bank erosion and loss of sediment.	Batter eroded banks back at 1V:4H from the toe, apply topsoil and revegetate.

13	Diversion - Stage 2	Erosion along toe.		Risk of further bank erosion and loss of sediment.	Batter eroded banks back at 1V:4H from the toe, apply topsoil and revegetate.
14	Diversion - Stage 2	Erosion along toe.		Risk of further bank erosion and loss of sediment.	Batter eroded banks back at 1V:4H from the toe, apply topsoil and revegetate.
15	Diversion - Stage 2	Erosion along toe.		Risk of further bank erosion and loss of sediment.	Batter eroded banks back at 1V:4H from the toe, apply topsoil and revegetate.
16	Diversion - Stage 2	Erosion along toe.		Risk of further bank erosion and loss of sediment.	Batter eroded banks back at 1V:4H from the toe, apply topsoil and revegetate.

## 4 Ripping, soil amelioration and revegetation works

### 4.1 Areas requiring works

The new areas to be ripped and treated are shown in Figure 6 below. Based on advice from Wambo Mine staff, areas downstream of this have already been subject to ripping and seeding. Success of those works will be evaluated over time and further maintenance recommended if required.

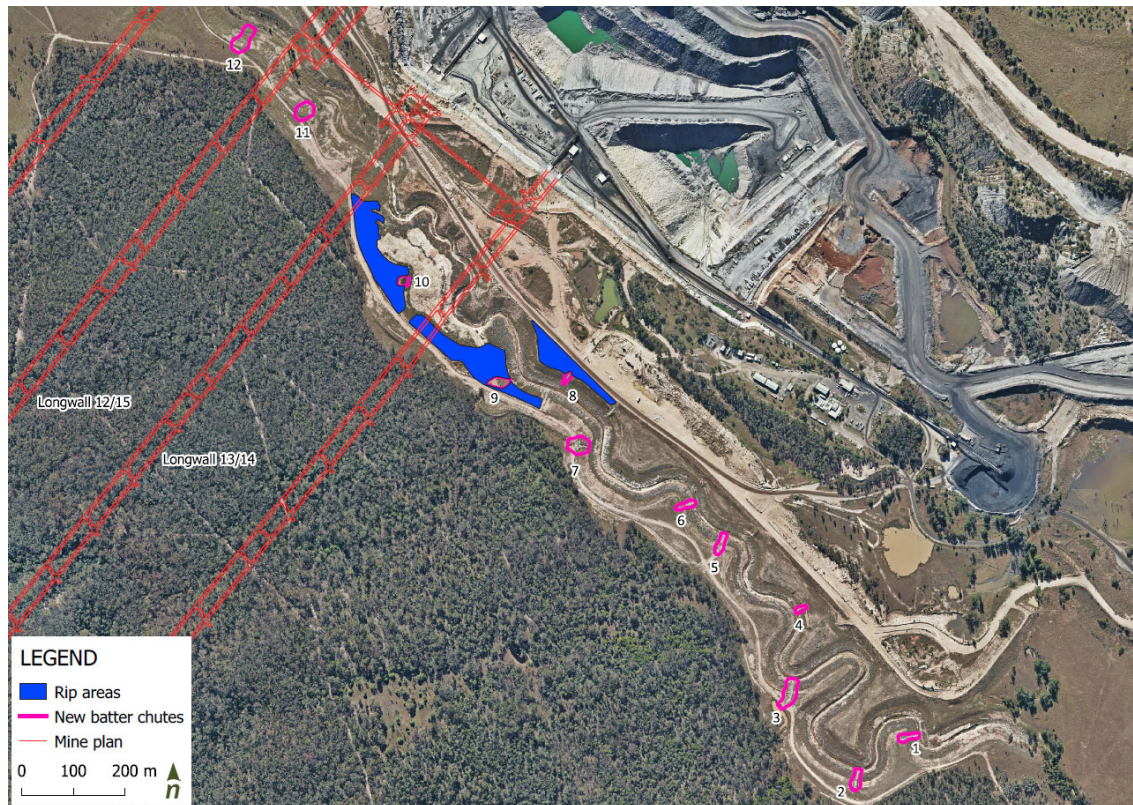

**Figure 6.** Areas requiring ripping and soil amelioration works.

### 4.2 Proposed rehabilitation methods

It should be noted that this document does not include a revegetation plan, which will need to be completed separately, it does however provide details on site preparation for revegetation efforts.

Good site preparation is essential for successful revegetation. Appropriate measures will minimise seedling losses, encourage healthy plant growth and minimise maintenance requirements. Conversely, poor preparation usually results in high rates of seedling loss and increased maintenance requirements.

#### **Weed management**

Weed management prior to revegetation reduces competition for nutrients, water and light. A weed-free environment helps new seedlings develop a vigorous root system that can access nutrients and soil moisture. This is most critical during their initial development and establishment. Ideally, weed control is undertaken a year or more in advance, though this is risky in erodible soils. To minimise the risk of exposed soils a surface mulch may be used to reduce the loss of soil moisture through evaporation and reduces runoff.

Non-chemical methods rely on smothering and usually require pinning in place to avoid disturbance from wind or water flow. Chemical herbicides may be the most effective method but should be used carefully near waterways and will likely need follow up applications to deplete the weed seedbank in the soil. For large areas

strip spraying may be used to avoid exposing the entire area. Prolonged use of chemicals can lead to resistance and should be used sparingly.

### **Ripping**

Ripping of soils makes planting easier and increases aeration and water infiltration, which improves root development by enabling deeper penetration and faster growth. On slopes, ripping should be done along the contour, though on flatter ground cross ripping on a grid layout should be used to prevent root development in one direction along a rip line. Soil should generally be ripped to a depth of at least 300 mm.

Sodic soils, which are anticipated at the site, are more prone to structural degradation and should receive minimal cultivation. The aim is to preserve soil organic matter in the surface soil and leave the more sodic subsoil at depth.

### **Soil amelioration**

Experience from previous rehabilitation works at sites with similar characteristics indicate that amelioration will likely need to address low Phosphorus (P) and high sodicity. The likely treatments are anticipated to be application of a high-P fertiliser and gypsum to address sodicity. These treatments will also improve soil structure and reduce erosion risk. For sodic soils, beneficial techniques involve high application rates of gypsum before tillage or concentrating gypsum into rip lines and is most effective at sowing time.

Soil testing will be undertaken during rehabilitation works once the site has been disturbed. Treatments and application rates will be determined prior to revegetation works.

## 5 References

Alluvium (2018). North Wambo Creek diversion – rehabilitation action plan by Alluvium Consulting Australia Pty Ltd for Wambo Coal Pty Ltd.



**Attachment A  
Design Drawings**

# WAMBO COAL NORTH WAMBO CREEK DIVERSION DETAILED ACTION PLAN

SCHEDULE OF DRAWINGS		
DRAWING NUMBER	REVISION	DRAWING TITLE
0219016 - 001	A	SCHEDULE OF DRAWINGS AND OVERVIEW
0219016 - 002	A	BATTER CHUTES 1, 2 & 3
0219016 - 003	A	BATTER CHUTES 4, 5 & 6
0219016 - 004	A	BATTER CHUTES 7, 8 & 9
0219016 - 005	A	BATTER CHUTES 10, 11 & 12
0219016 - 006	A	BATTER CHUTE TYPICAL DETAILS
0219016 - 007	A	BATTER CHUTE SPECIFICATIONS AND DETAILS

## GENERAL NOTES

1. THESE DRAWINGS ARE TO BE READ IN CONJUNCTION WITH THE TECHNICAL SPECIFICATIONS. ANY DISCREPANCY SHALL BE REFERRED TO THE SUPERINTENDENT FOR DECISION BEFORE PROCEEDING WITH THE WORK.
2. ALL WORKMANSHIP AND MATERIALS SHALL COMPLY WITH THE DRAWINGS AND TECHNICAL SPECIFICATIONS AND RELEVANT AUSTRALIAN STANDARDS.
3. CONTOURS SHOWN ARE AT 0.5m INTERVALS.
4. ALL LEVELS PROVIDED ARE IN METRES TO AUSTRALIAN HEIGHT DATUM (AHD).
5. ALL CO-ORDINATES PROVIDED ARE IN METRES TO DATUM GDA94 AND PROJECTION AMG ZONE 56.
6. ALL DESIGN OFFSETS AND CHAINAGES PROVIDED ARE IN METRES UNLESS NOTED OTHERWISE.
7. THE CONTRACTOR SHALL VERIFY ALL DIMENSIONS ON SITE BEFORE COMMENCING ANY WORKS.
8. IT IS THE CONTRACTOR'S RESPONSIBILITY TO CONFIRM THE LOCATION AND DEPTH OF ALL OBSTRUCTIONS AND UNDERGROUND SERVICES IN THE VICINITY OF THE PROPOSED WORKS PRIOR TO THE COMMENCEMENT OF ANY WORKS.
9. ALL STRUCTURES SHALL BE MAINTAINED IN A SAFE AND STABLE CONDITION DURING CONSTRUCTION. IT IS THE CONTRACTOR'S RESPONSIBILITY TO ENSURE NO PART OF ANY STRUCTURE IS OVERSTRESSED DURING CONSTRUCTION PROCEDURES.
10. THE DTM USED TO CREATE THE DRAWING SET MAY NOT ILLUSTRATE ALL CURRENT FEATURES.
11. ALL REASONABLE EFFORTS SHALL BE MADE TO PRESERVE AND PROTECT EXISTING VEGETATION.
12. DISTURBANCE OF VEGETATION SHALL BE IN ACCORDANCE WITH THE TECHNICAL SPECIFICATIONS AND SHALL NOT COMMENCE WITHOUT PRIOR APPROVAL FROM THE SUPERINTENDENT.
13. ALL CROSS SECTIONS ARE SHOWN LOOKING IN THE DIRECTION OF CONTROL LINE CHAINAGE INCREASE UNLESS NOTED OTHERWISE.
14. DIGITAL DESIGN STRINGS HAVE BEEN PROVIDED FOR SETOUT AND CONSTRUCTION OF DIVERSION, BATTER DRAINS AND SPOIL DUMPS.
15. SUPPLY AND PLACEMENT OF ROCK AND GRANULAR FILTER TO BE IN ACCORDANCE WITH THE DRAWINGS AND TECHNICAL SPECIFICATIONS.
16. DRAWING NUMBERS WRITTEN AS DWG 001-002 ETC REFER TO DRAWINGS 0219016-001-002 ETC.

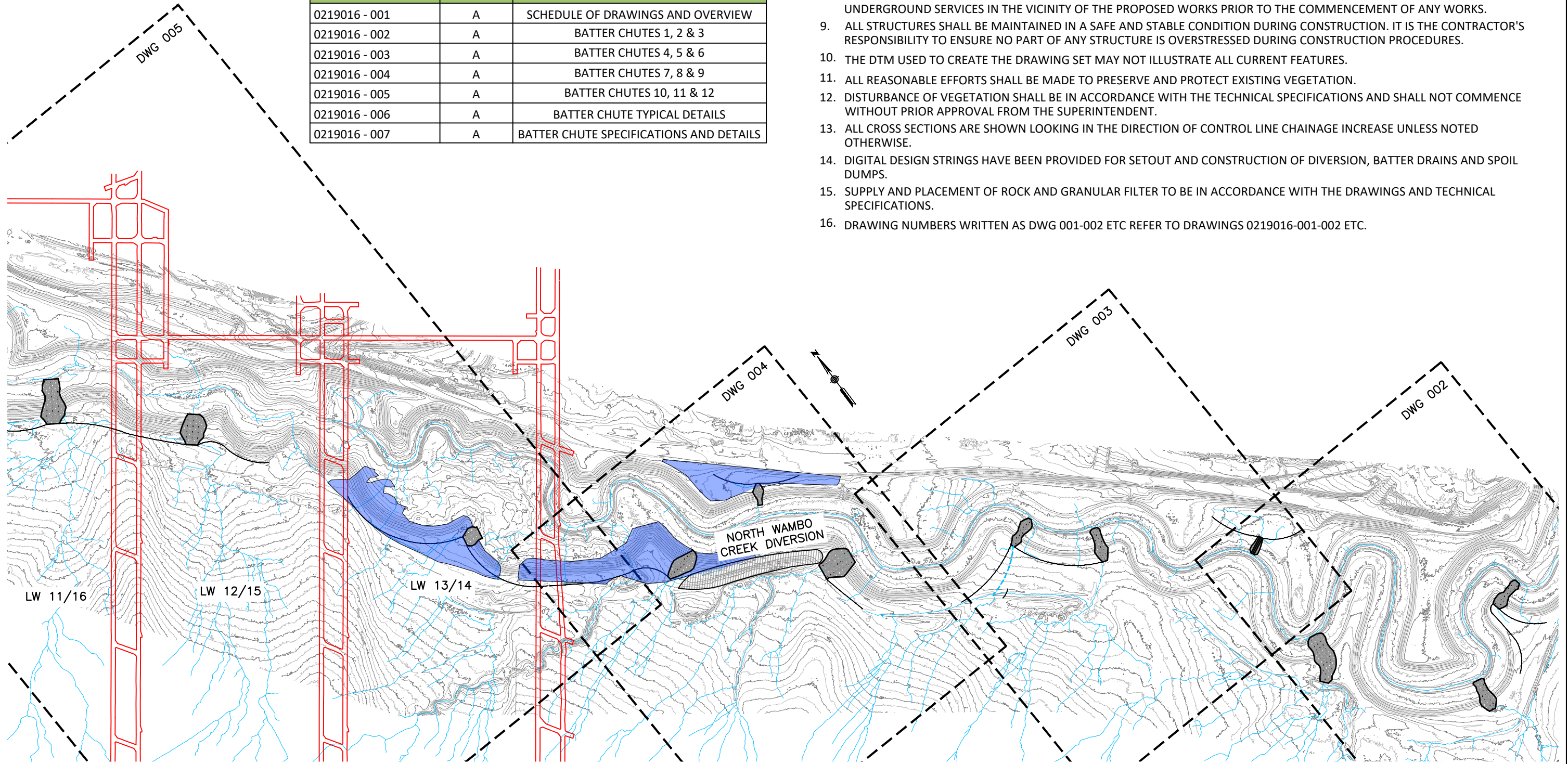

REV	DESCRIPTION	APP'D	DATE
A	PRELIMINARY ISSUE	RL	04.04.19

LEGEND	
LONGWALL PANEL	
NEW/REPAIRED ROCK BATTER CHUTE	
FLOW DIVERSION BUND	
EXISTING FLOW PATH	
AREAS TO BE RIPPED	

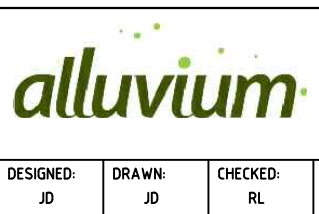
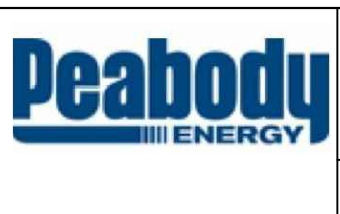

Alluvium Consulting Australia Pty. Ltd.  
 ABN 76 151 119 792  
 412 Flinders Street  
 Townsville QLD 4810  
 T (07) 3257 1628  
 www.alluvium.com.au

WAMBO COAL NORTH WAMBO CREEK DIVERSION DETAILED ACTION PLAN SCHEDULE OF DRAWINGS AND OVERVIEW			
DESIGNED:	DRAWN:	CHECKED:	APPROVED:
JD	JD	RL	RL
PROJECT No:	REVISION:	SHEET No.:	ORIGINAL SIZE:
0219016	A	001	A1
DATE:		SCALE:	
04.04.19		1:1	
DATUM: m AHD (MGA z56)			

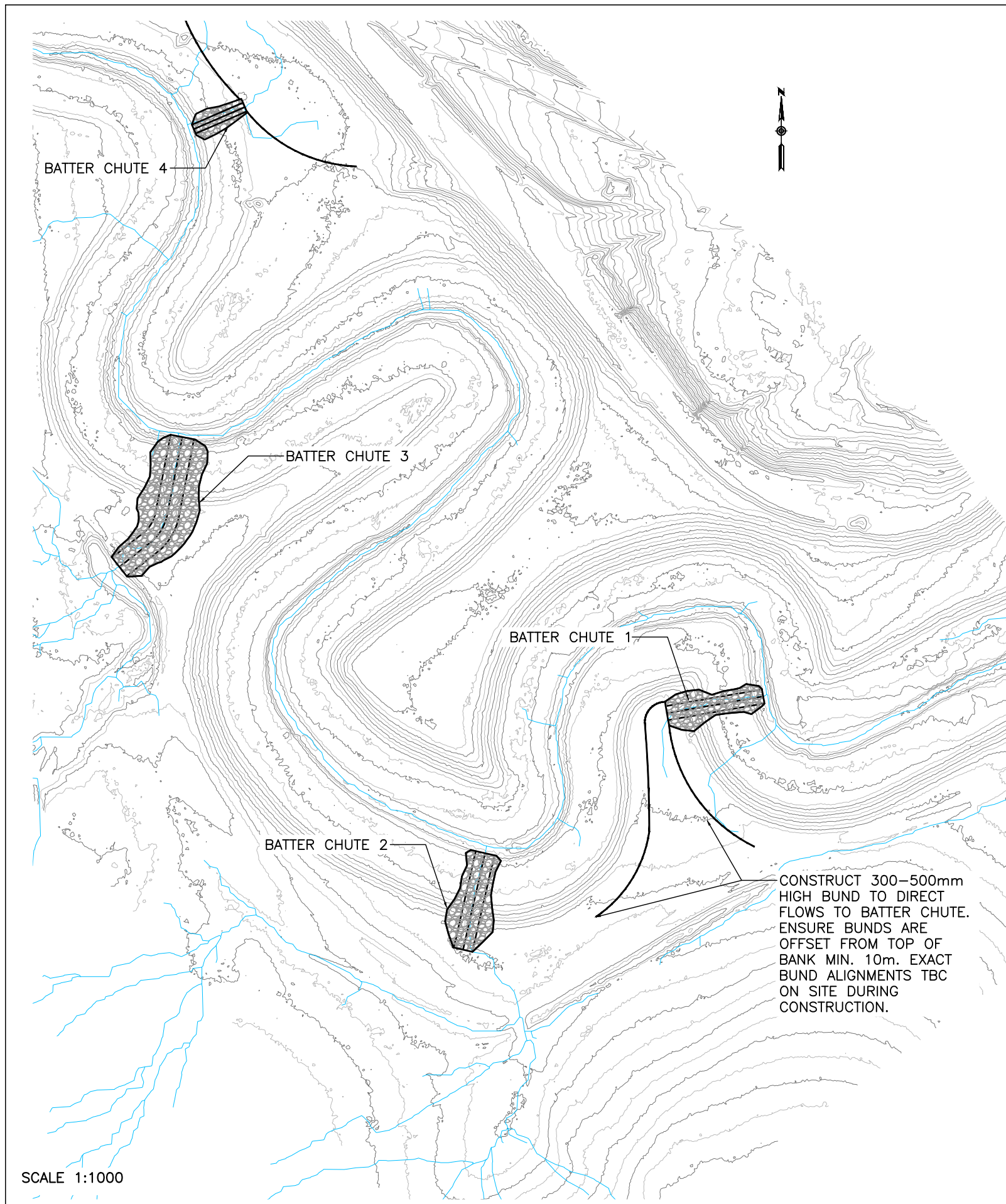

SCALE 1:1000

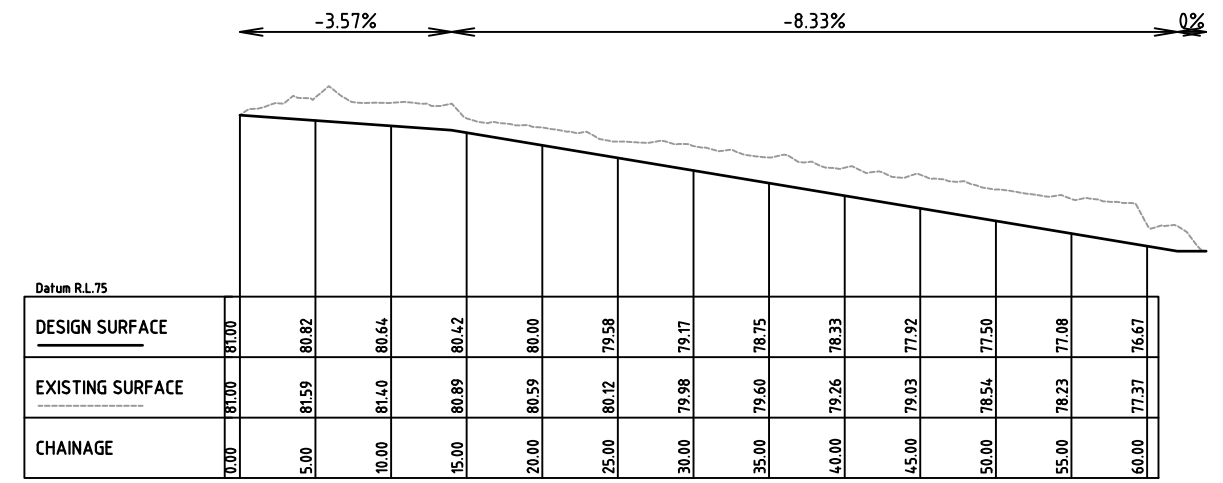
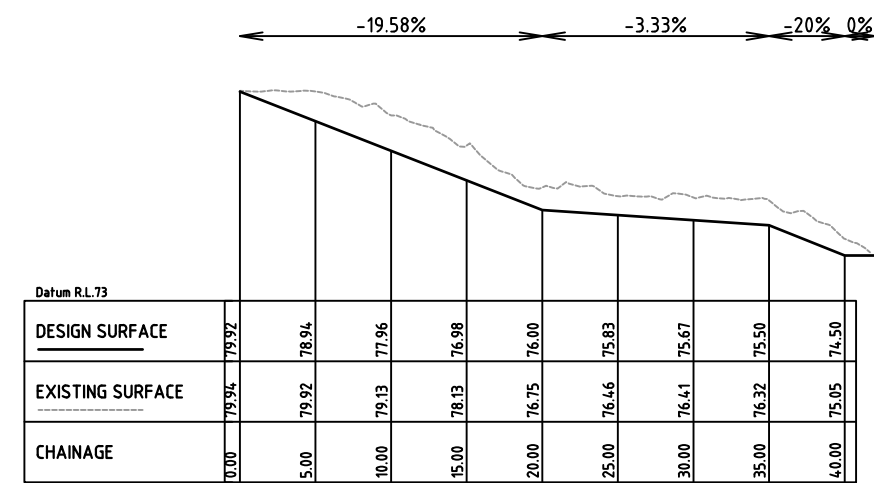
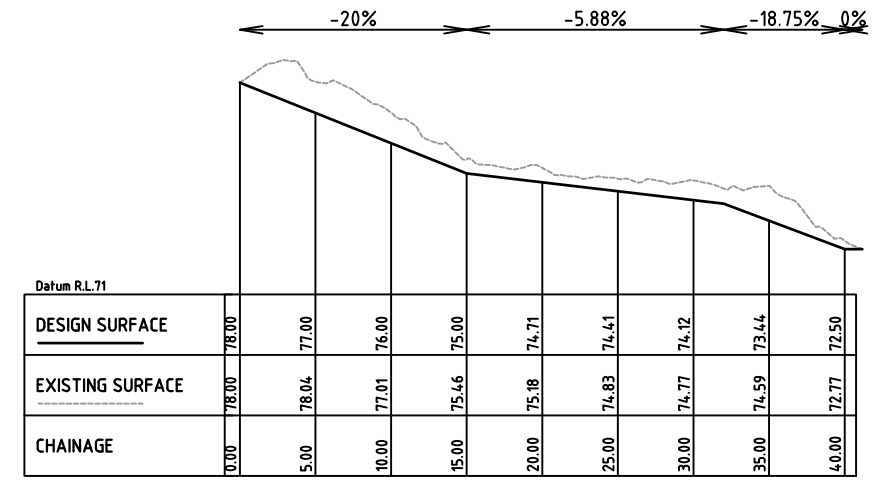

LONGITUDINAL SCALE  
HORIZONTAL SCALE:1:250  
VERTICAL SCALE:1:500

A	PRELIMINARY ISSUE	RL	04.04.19
REV	DESCRIPTION	APP'D	DATE

**Peabody ENERGY** *alluvium*

Alluvium Consulting Australia Pty. Ltd.  
ABN 76 151 119 792  
412 Flinders Street  
Townsville QLD 4810  
T (07) 3257 1628  
www.alluvium.com.au

DESIGNED: JD	DRAWN: JD	CHECKED: RL	APPROVED: RL	PROJECT No: 0219016
--------------	-----------	-------------	--------------	---------------------

**WAMBO COAL**  
NORTH WAMBO CREEK DIVERSION  
DETAILED ACTION PLAN  
BATTER CHUTES 1, 2 & 3

REVISION: A	SHEET No.: 002	ORIGINAL SIZE: A1	SCALE:
DATUM: m AHD (MGA z56)			

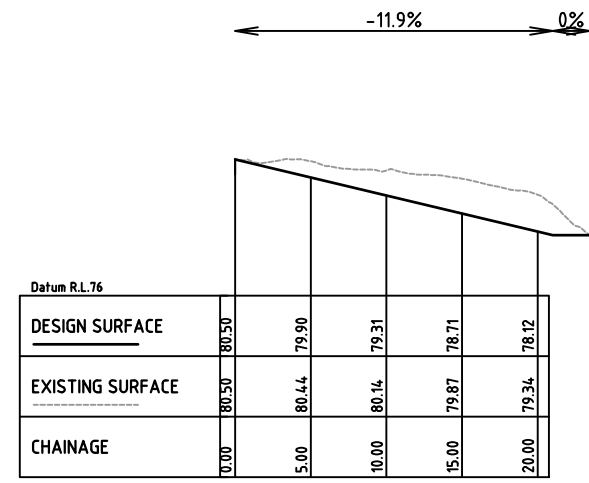
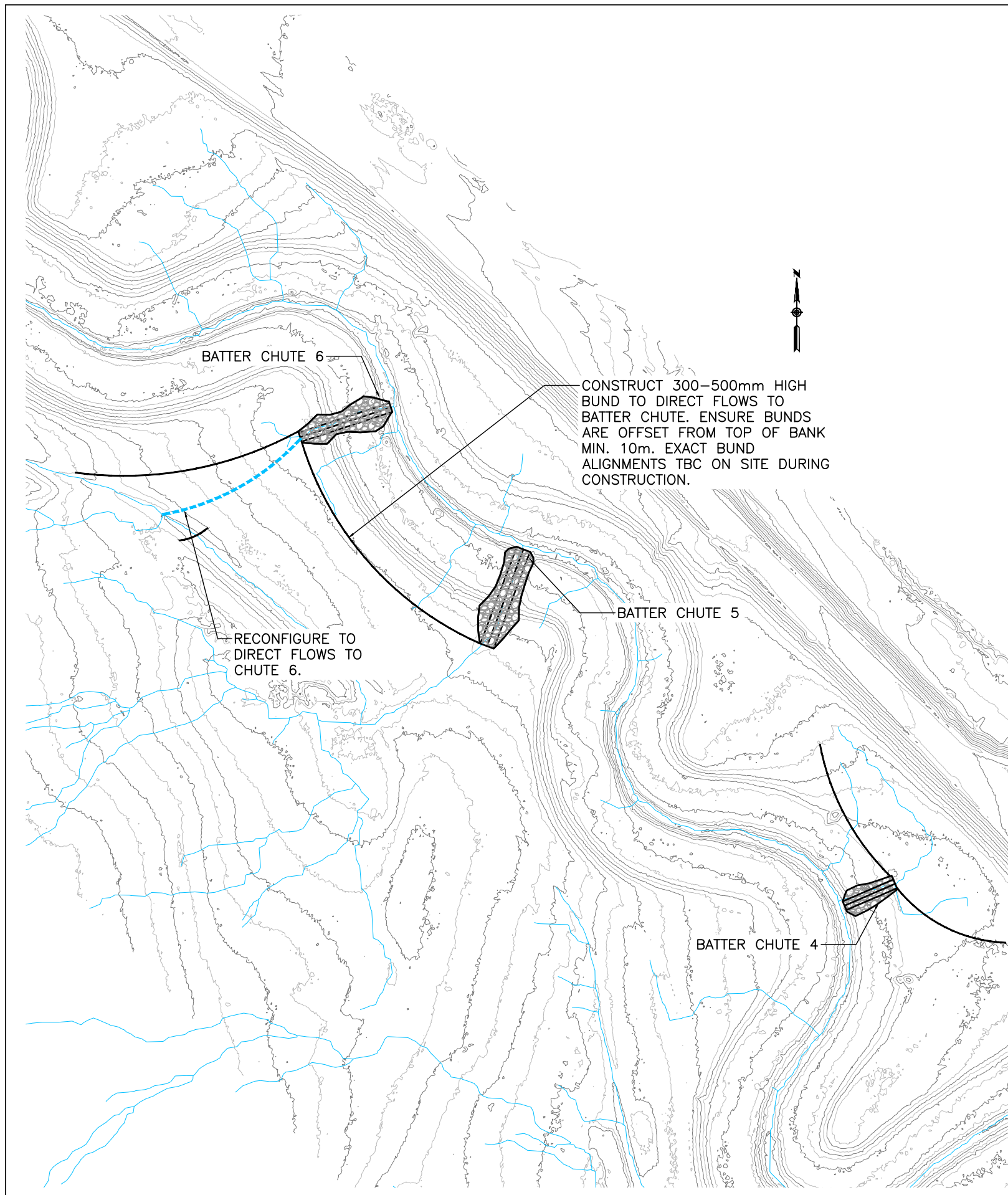

BATTER CHUTE 4

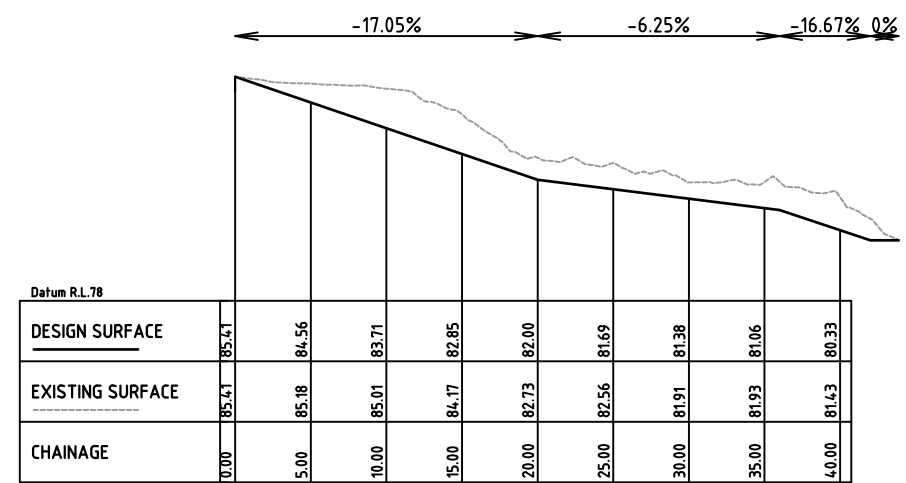

BATTER CHUTE 5

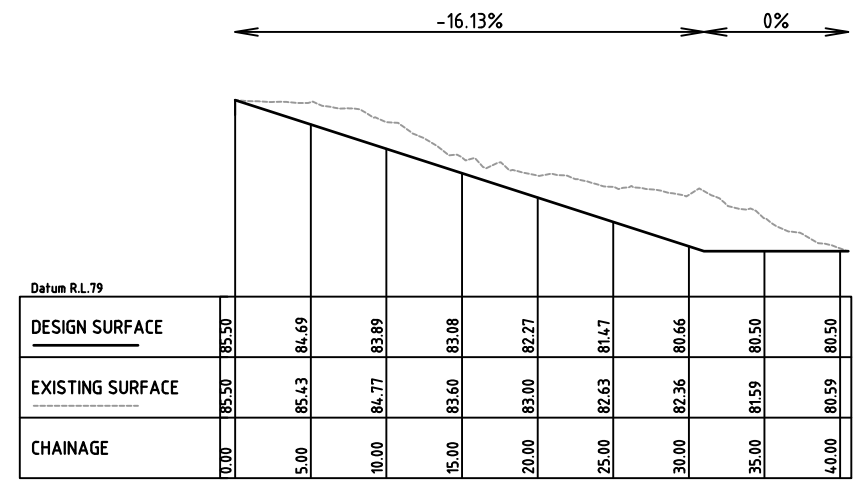

BATTER CHUTE 6

LONGITUDINAL SCALE  
HORIZONTAL SCALE: 1:250  
VERTICAL SCALE: 1:500

A	PRELIMINARY ISSUE	RL	04.04.19
REV	DESCRIPTION	APP'D	DATE

Alluvium Consulting Australia Pty. Ltd.  
ABN 76 151 119 792  
412 Flinders Street  
Townsville QLD 4810  
T (07) 3257 1628  
www.alluvium.com.au

DESIGNED: JD	DRAWN: JD	CHECKED: RL	APPROVED: RL	PROJECT No: 0219016
--------------	-----------	-------------	--------------	---------------------

**WAMBO COAL**  
NORTH WAMBO CREEK DIVERSION  
DETAILED ACTION PLAN  
BATTER CHUTES 4, 5 & 6

REVISION: A	SHEET No.: 003	ORIGINAL SIZE: A1	SCALE:
		DATUM: m AHD (MGA z56)	

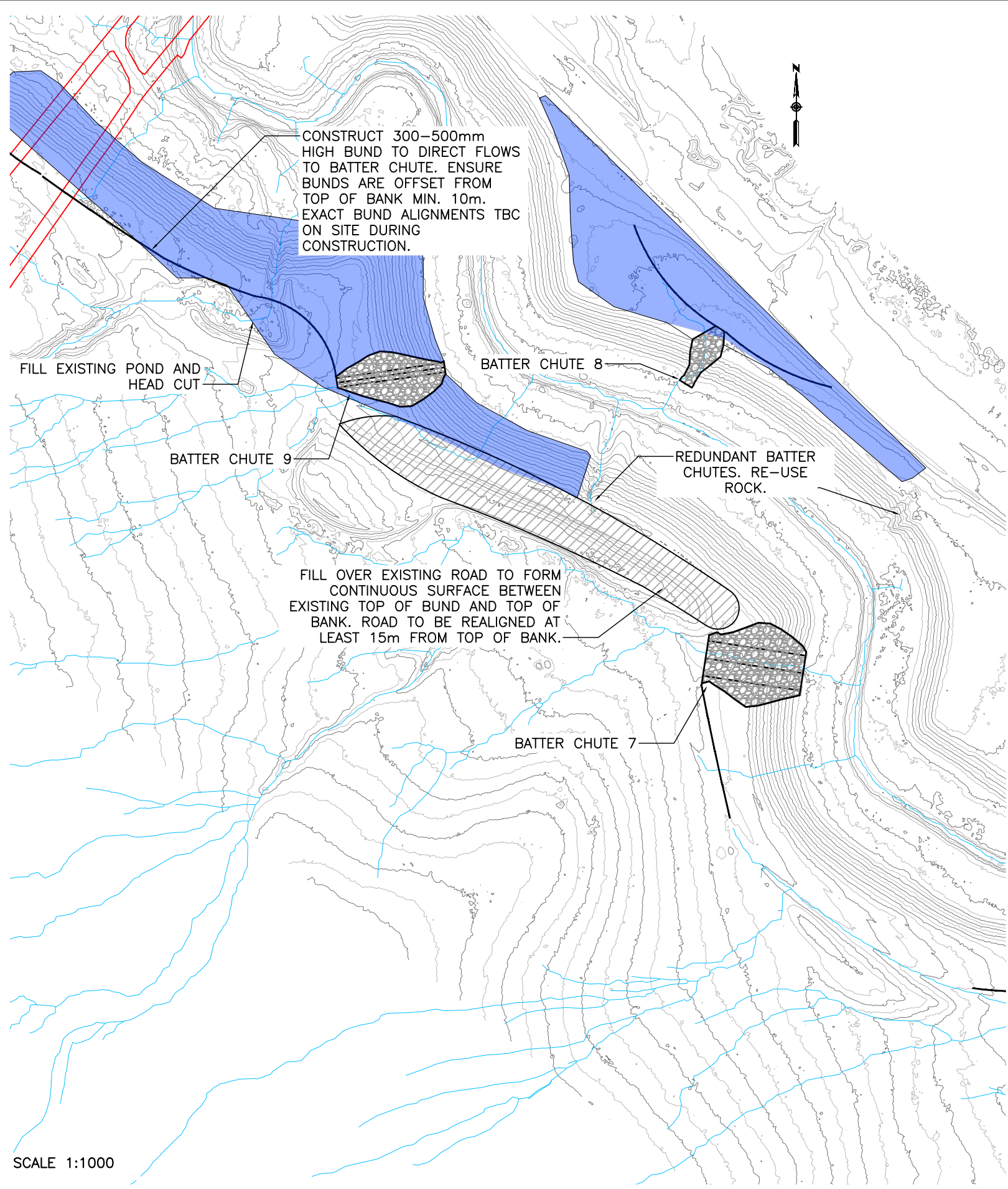

SCALE 1:1000

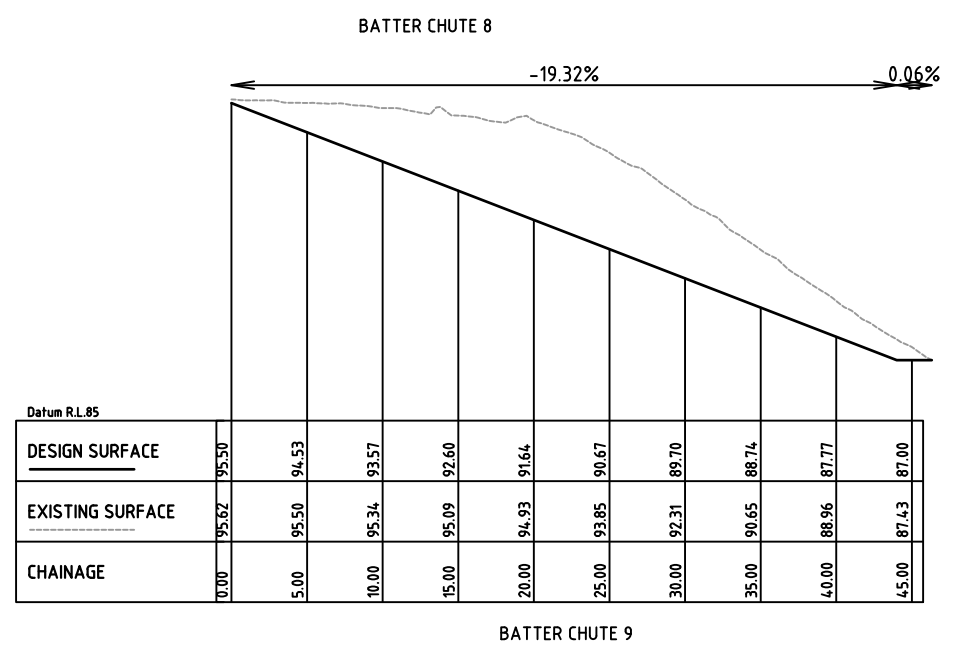
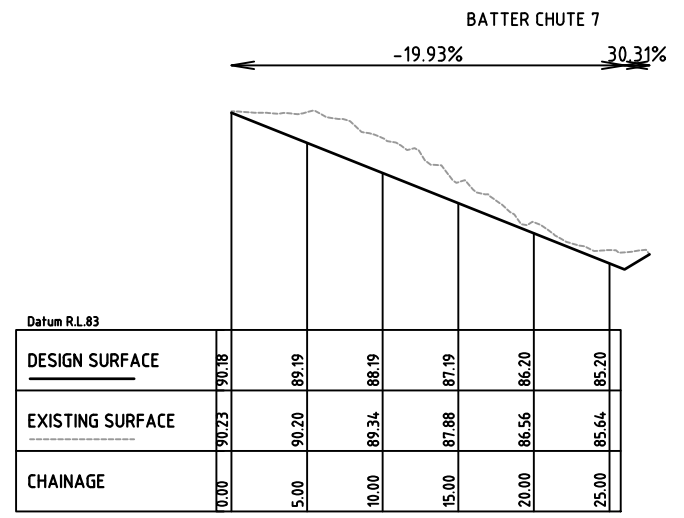
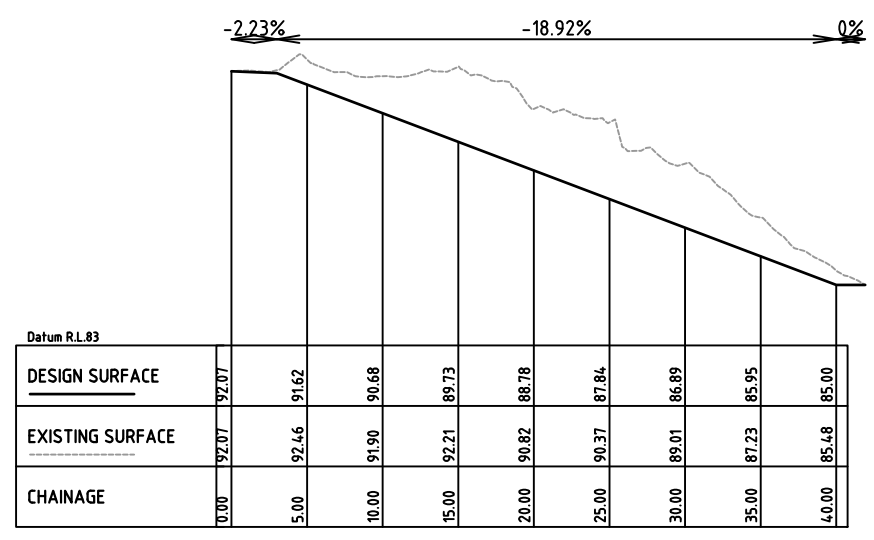

LONGITUDINAL SCALE  
HORIZONTAL SCALE:1:250  
VERTICAL SCALE:1:500

A	PRELIMINARY ISSUE	RL	04.04.19
REV	DESCRIPTION	APP'D	DATE

**Peabody ENERGY** *alluvium*

Alluvium Consulting Australia Pty. Ltd.  
ABN 76 151 119 792  
412 Flinders Street  
Townsville QLD 4810  
T (07) 3257 1628  
www.alluvium.com.au

DESIGNED:	DRAWN:	CHECKED:	APPROVED:	PROJECT No:
JD	JD	RL	RL	0219016

**WAMBO COAL**  
NORTH WAMBO CREEK DIVERSION  
DETAILED ACTION PLAN  
BATTER CHUTES 7, 8 & 9

REVISION:	SHEET No.:	ORIGINAL SIZE:	SCALE:
A	004	A1	
DATUM: m AHD (MGA z56)			

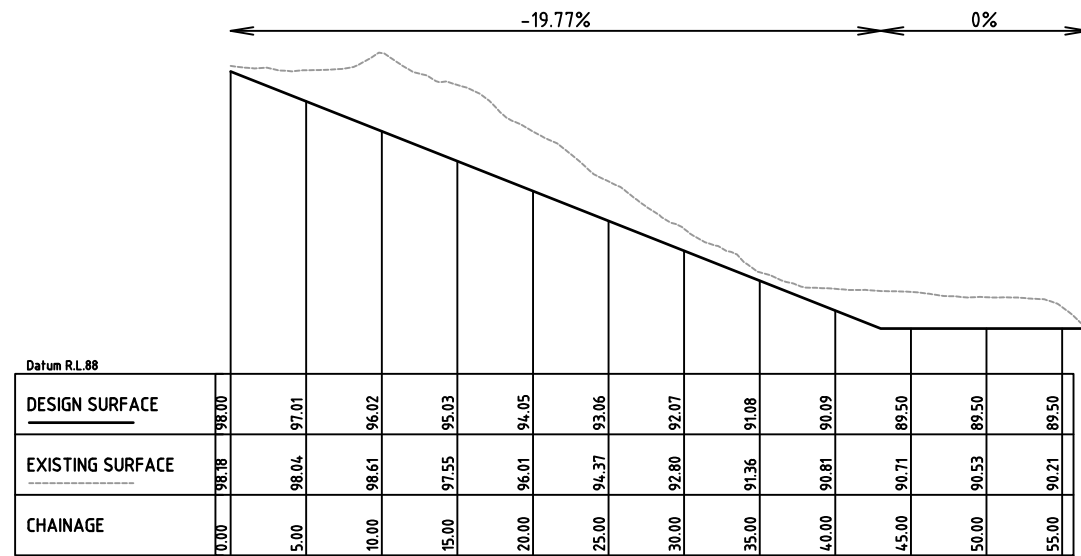
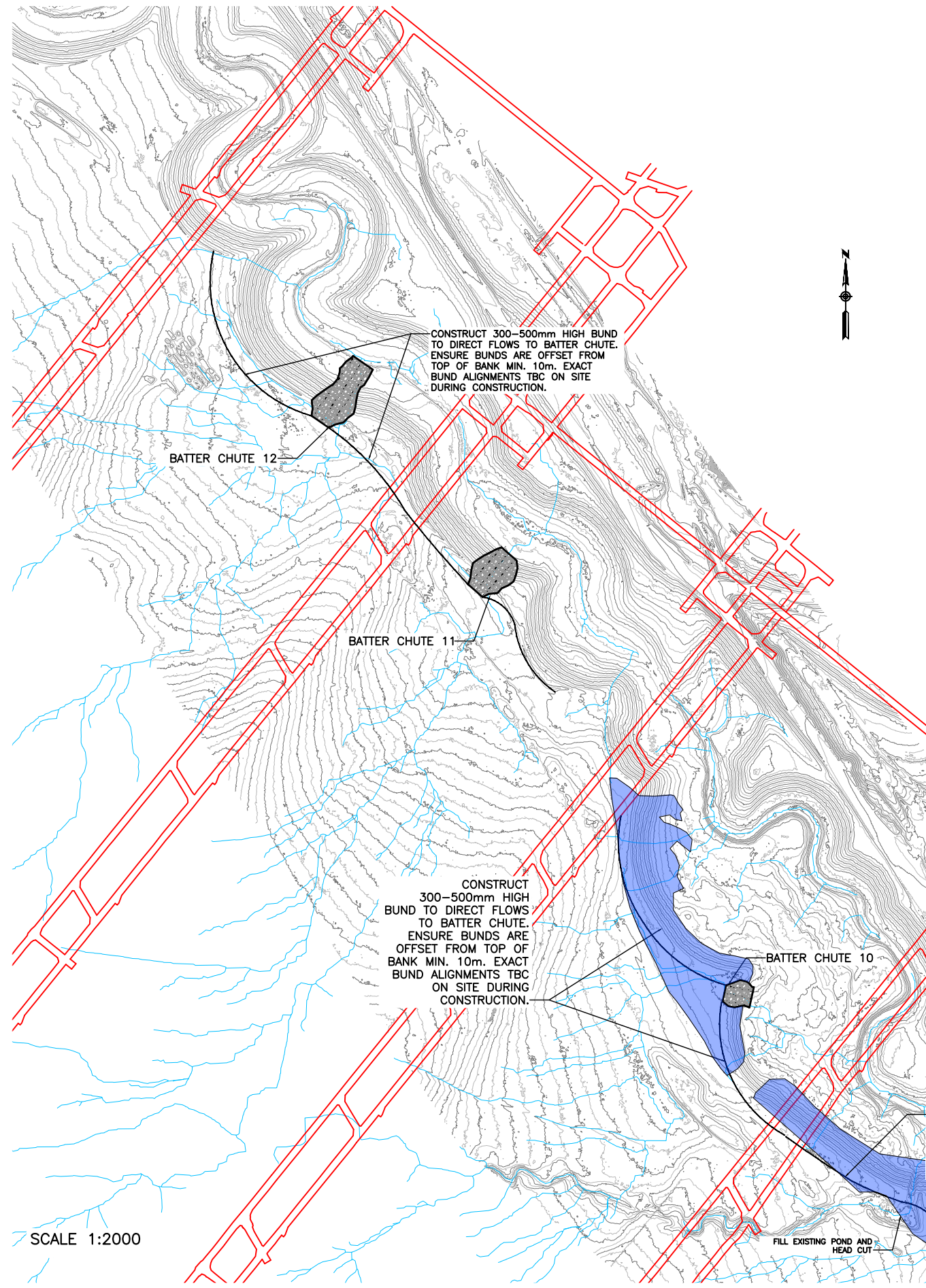

BATTER CHUTE 12

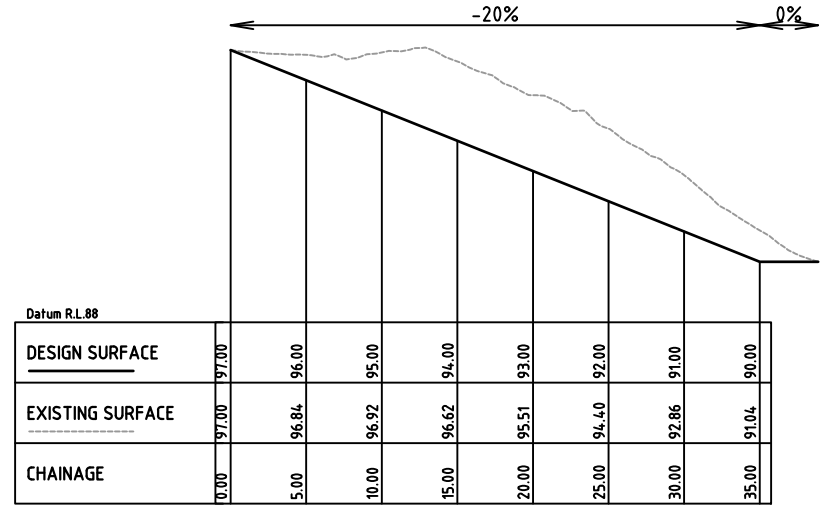

BATTER CHUTE 11

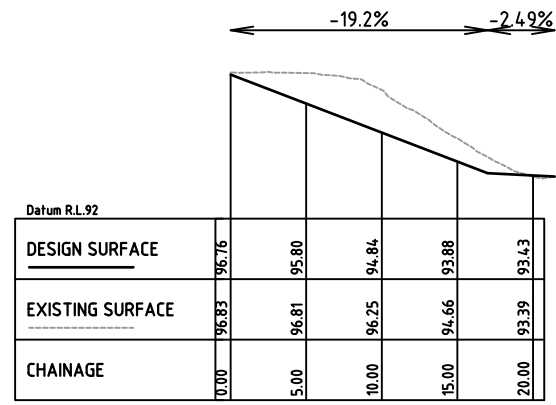

BATTER CHUTE 10

LONGITUDINAL SCALE  
HORIZONTAL SCALE:1:250  
VERTICAL SCALE:1:500

A	PRELIMINARY ISSUE	RL	04.04.19
REV	DESCRIPTION	APP'D	DATE

**Peabody ENERGY** *alluvium*

Alluvium Consulting Australia Pty. Ltd.  
ABN 76 151 119 792  
412 Flinders Street  
Townsville QLD 4810  
T (07) 3257 1628  
www.alluvium.com.au

DESIGNED: JD	DRAWN: JD	CHECKED: RL	APPROVED: RL	PROJECT No: 0219016
--------------	-----------	-------------	--------------	---------------------

**WAMBO COAL**  
NORTH WAMBO CREEK DIVERSION  
DETAILED ACTION PLAN  
BATTER CHUTES 10, 11 & 12

REVISION: A	SHEET No.: 005	ORIGINAL SIZE: A1	SCALE:
		DATUM: m AHD (MGA z56)	

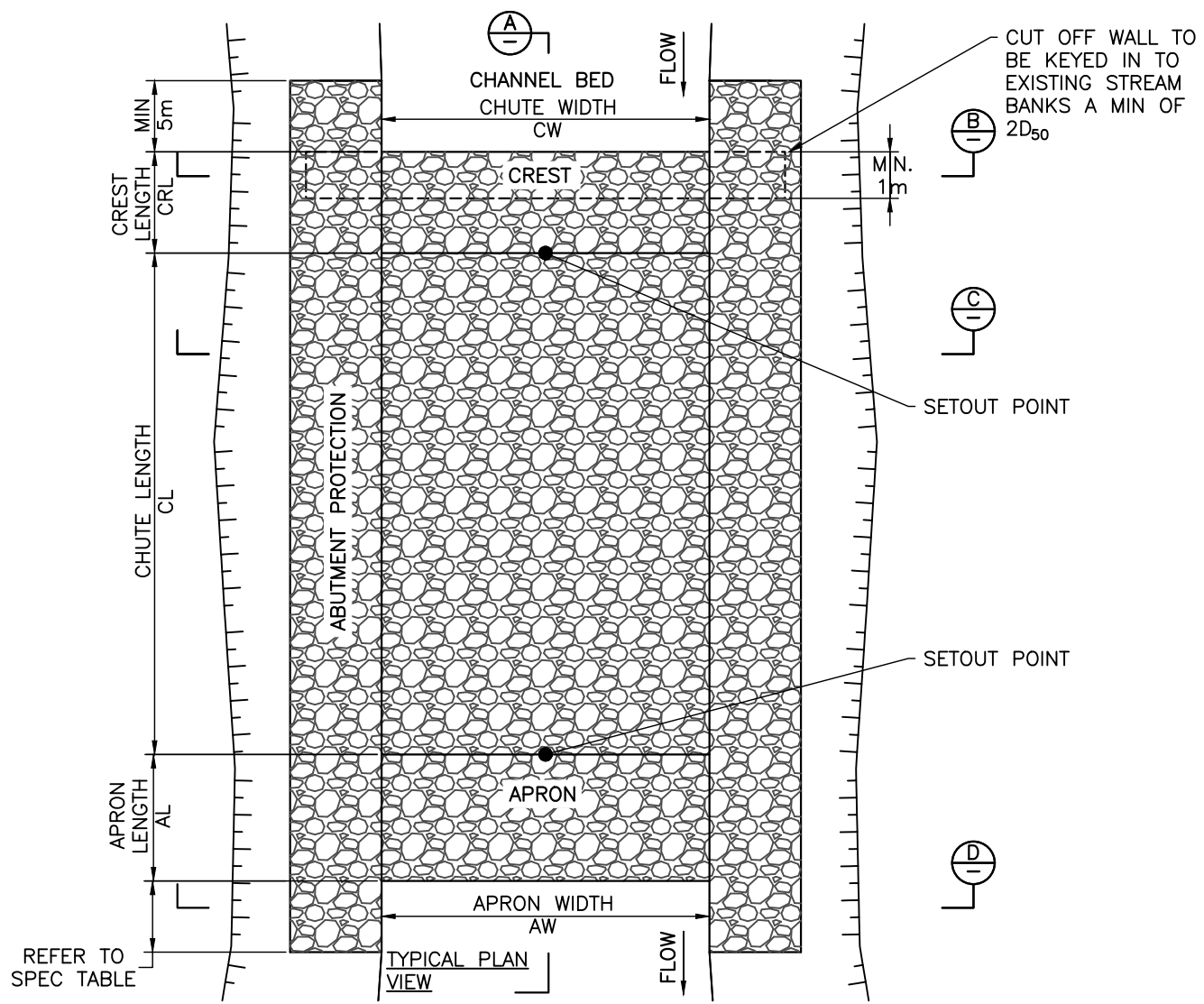
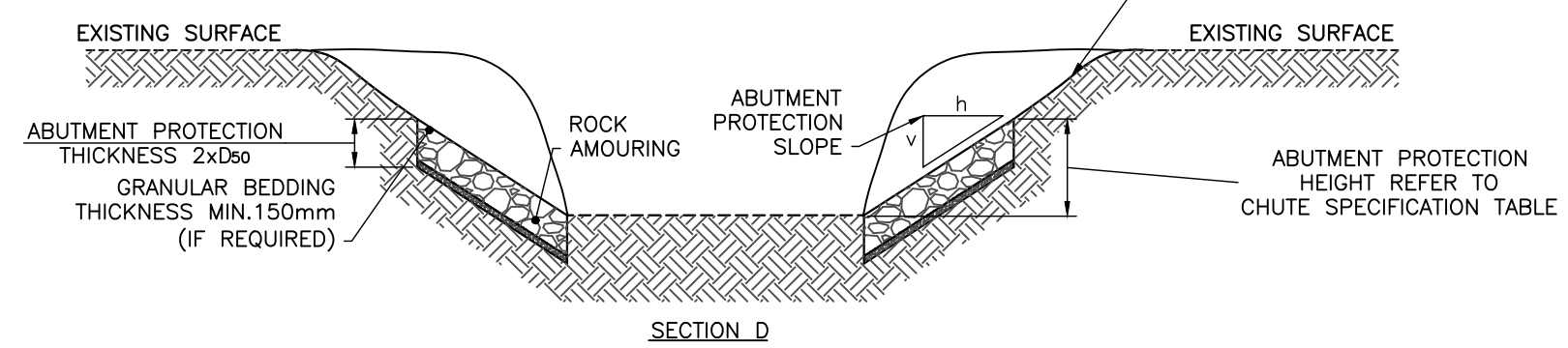
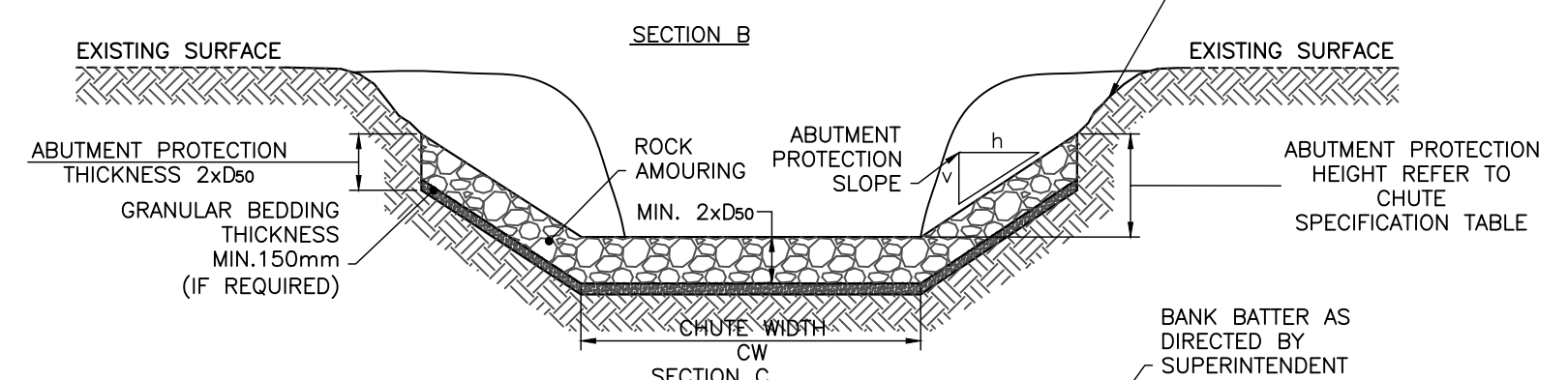
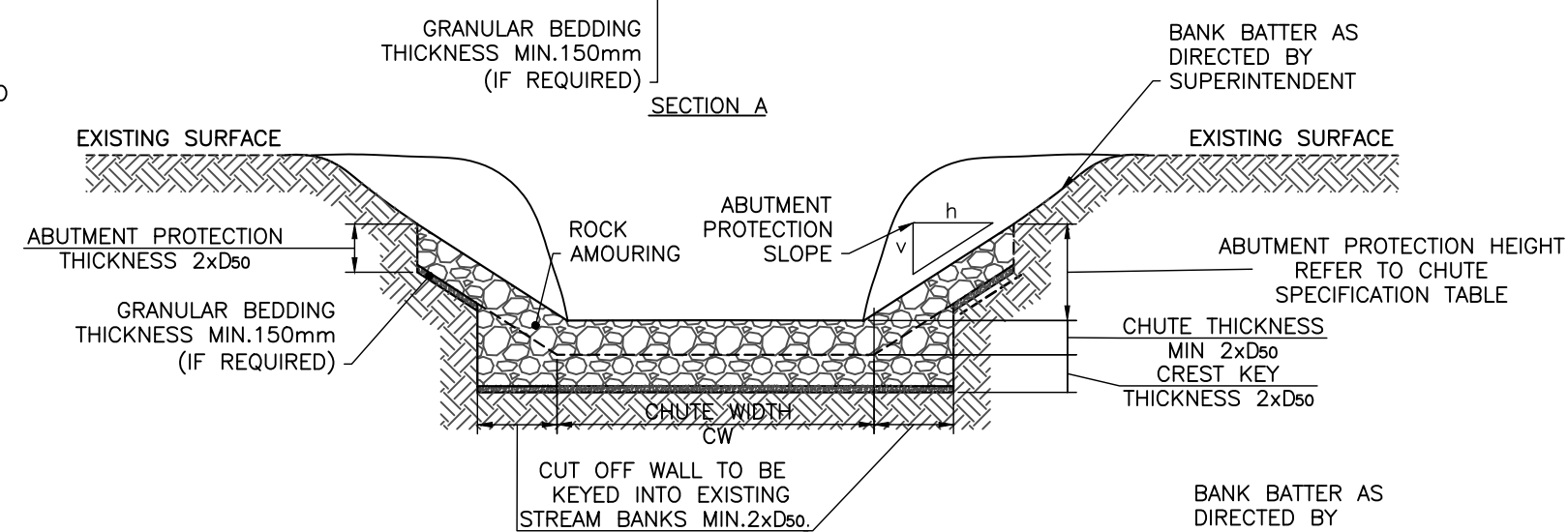
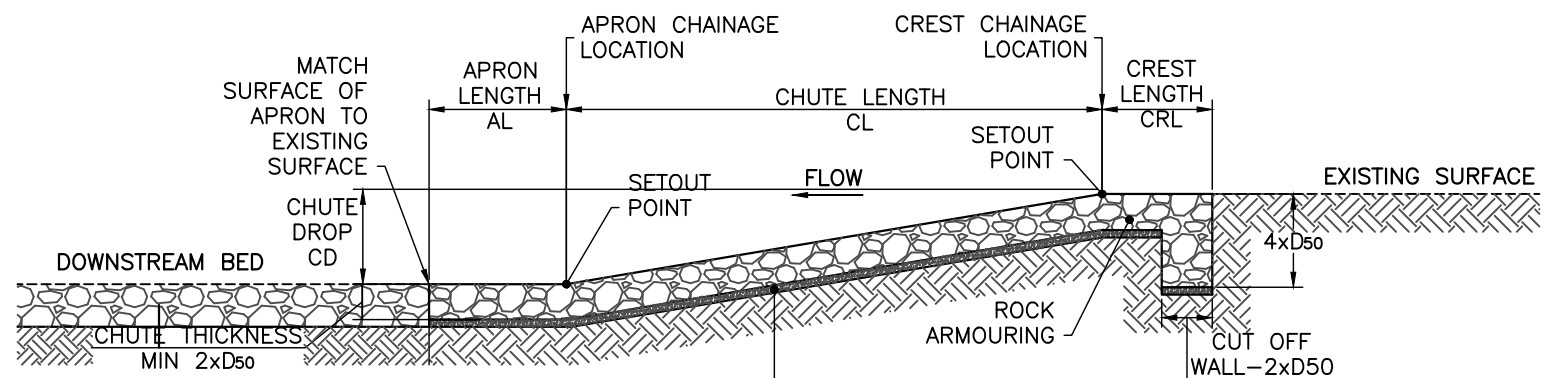

A	PRELIMINARY ISSUE	RL	04.04.19
REV	DESCRIPTION	APP'D	DATE

Alluvium Consulting Australia Pty. Ltd.  
 ABN 76 151 119 792  
 412 Flinders Street  
 Townsville QLD 4810  
 T (07) 3257 1628  
 www.alluvium.com.au

**WAMBO COAL**  
 NORTH WAMBO CREEK DIVERSION  
 DETAILED ACTION PLAN  
 BATTER CHUTE TYPICAL DETAILS

DESIGNED: JD	DRAWN: JD	CHECKED: RL	APPROVED: RL	PROJECT No: 0219016	REVISION: A	SHEET No.: 006	ORIGINAL SIZE: A1	SCALE:
							DATUM: m AHD (MGA z56)	

BATTER CHUTE SPECIFICATION TABLE

BATTER CHUTE ELEMENT	SYMBOL	UNITS	BATTER CHUTE 1		BATTER CHUTE 2		BATTER CHUTE 3	BATTER CHUTE 4	BATTER CHUTE 5		BATTER CHUTE 6	BATTER CHUTE 7	BATTER CHUTE 8	BATTER CHUTE 9	BATTER CHUTE 10	BATTER CHUTE 11	BATTER CHUTE 12
			UPPER	LOWER	UPPER	LOWER			UPPER	LOWER							
CHUTE LENGTH	CL	m	15	8	20	5	48	21	20	6	31	37	26	44	17	35	43
CHUTE DROP	CD	m	3.0	1.5	4.0	1.0	4	2.5	3.5	1	5	7	5.2	8.5	3.3	7	8.5
CHUTE WIDTH	CW	m	6	6	8	8	10	4	6	6	4	15	4	4	12	14	15
CREST LENGTH	CRL	m	0	0	0	0	14	0	0	0	0	3	0	0	0	0	0
CREST RL	-	m	78.0	74.0	80.0	75.5	81 (u/s) 80.5 (d/s)	80.5	85.5	81	85.5	92	90.2	95.5	97	97	98
CREST HEIGHT ABOVE BED	-	m	0.0	0.0	0.0	N/A	0	0	0	0	0	0	0	0	0	0	0
APRON LENGTH	AL	m	17	1	15	2	2	2.5	16	2	9.5	2	1.5	2	4.5	4	13.5
APRON RL (END OF CHUTE/START OF APRON)	-	m	75.0	72.5	76.0	74.5	76.5	78	82	80	80.5	85	85	87	93.5	90	89.5
APRON RISE	-	m	-1	0	-0.5	0	0	0	-1	0	0	0	0.5	0	0	0	0
APRON RL (END OF APRON)	-	m	74.0	72.5	75.5	74.5	76.5	78	81	80	80.5	85	85.5	87	93.5	90	89.5
CREST SETOUT COORDINATES		EASTING	309763.5	309795.0	309677.6	309685.4	309543.8	309586.0	309412.3	309425.0	309332.9	309126.9	309130.2	308967.1	308794.3	308600.7	308480.2
		NORTHING	6393164.5	6393170.0	6393064.9	6393099.0	6393234.8	6393420.0	6393520.9	6393554.6	6393609.6	6393734.2	6393874.7	6393851.7	6394051.1	6394363.9	6394495.2
APRON SETOUT COORDINATES		EASTING	309778.3	309802.9	309682.0	309686.5	309558.9	309566.0	309419.4	309427.1	309362.4	309163.4	309116.4	309010.7	308810.9	308623.8	308504.8
		NORTHING	6393167.1	6393171.4	6393084.4	6393103.9	6393279.0	6393412.0	6393539.6	6393560.2	6393619.2	6393728.7	6393852.6	6393858.0	6394047.5	6394390.2	6394530.6
VOLUME OF CUT	-	m <sup>3</sup>	585		915		2158	281	758		547	2487	268	1337	573	1982	2409
SIZE OF ROCK	D50	mm	300		400		450	450	400		400	450	300	450	450	450	450
ABUTMENT PROTECTION HEIGHT	-	m	1		1		1	1	1		1	1	1	1	1	1	1
ABUTMENT PROTECTION SLOPE	-	m/m	1V:3H		1V:3H		1V:3H	1V:3H	1V:3H		1V:3H	1V:3H	1V:3H	1V:3H	1V:3H	1V:3H	1V:3H
QUANTITY OF ROCK REQUIRED	-	m <sup>3</sup>	225		375		758	151	323		232	687	118	297	293	602	924
	-	tonnes	360		600		1210	240	520		370	1100	190	470	470	960	1480
GRANULAR FILTER LAYER (150mm LAYER)	-	m <sup>3</sup>	77		99		204	33	85		68	185	38	120	61	154	207

A	PRELIMINARY ISSUE	RL	04.04.19
REV	DESCRIPTION	APP'D	DATE



Alluvium Consulting Australia Pty. Ltd.  
 ABN 76 151 119 792  
 412 Flinders Street  
 Townsville QLD 4810  
 T (07) 3257 1628  
 www.alluvium.com.au

DESIGNED:	DRAWN:	CHECKED:	APPROVED:	PROJECT No:
JD	JD	RL	RL	0219016

**WAMBO COAL**  
 NORTH WAMBO CREEK DIVERSION  
 DETAILED ACTION PLAN  
 BATTER CHUTE SPECIFICATIONS AND SETOUT

REVISION:	SHEET No.:	ORIGINAL SIZE:	SCALE:
A	007	A1	
		DATUM: m AHD (MGA z56)	





## Attachment B Technical Specifications



**TECHNICAL SPECIFICATION – DIVERSION STABILISATION WORKS**

NWCD Detailed Action Plan Detailed Design

April 2019

## Document history

### Revision:

Revision no.	01
Author/s	Jacob Dearlove Rohan Lucas
Checked	Rohan Lucas
Approved	Rohan Lucas (RPEQ)

### Distribution:

Revision no.	01
Issue date	04/04/2019
Issued to	Nicole Dobbins
Description:	Original issue

### Ref:

V:\Work\2019\0219016\_North\_Wambo\_Creek\_Detailed\_Action\_Plan\10\_Project\1\_Deliverables\0219016\_R01\_Technical\_Specification.docx

# Contents

<b>1</b>	<b>Introduction</b>	<b>1</b>
1.1	Site of works	1
1.2	Timing of works	1
1.3	Scope of works	1
	General	2
	Formation of batter chutes	2
	Ripping, soil amelioration and vegetation establishment	2
	Site reinstatement	2
1.4	Standards	2
1.5	Project drawings	2
1.6	Sequence of works	3
1.7	Hold points and inspection requirements	3
1.8	Survey	5
1.9	Storage of materials	6
1.10	Protection of the environment	6
1.11	Fencing	7
1.12	Safety	7
1.13	Permit to disturb	7
1.14	Utilities	7
1.15	Definitions and interpretations	7
<b>2</b>	<b>Codes and standards</b>	<b>9</b>
<b>3</b>	<b>Control of water and sediment</b>	<b>9</b>
<b>4</b>	<b>Site preparation</b>	<b>10</b>
4.1	Set out of works	10
	Set out – for clearing and grubbing of vegetation, removal of existing rock beaching and stripping of topsoil	10
	Set out – for excavation (all components)	10
4.2	Clearing and grubbing of vegetation	10
	Extent of clearing	10
	Clearing	11
	Disposal of cleared vegetation	11
4.3	Stripping and stockpiling of topsoil and rock beaching	11
<b>5</b>	<b>Earthworks</b>	<b>11</b>
5.1	General	11
5.2	Tolerances	11
5.3	Excavation	12
5.4	Materials	12
	Fill materials	12
	Earth fill materials	13
5.5	Excavation methods	14
5.6	Removal of unsuitable material	14
5.7	Spoil dumps	14

5.8	Stockpiles	14
5.9	Blasting	15
<b>6</b>	<b>Filling</b>	<b>15</b>
6.1	General	15
6.2	Approval by Superintendent	15
6.3	Placement of fill	16
6.4	Moisture Conditioning	16
6.5	Compaction and Moisture Content Criteria	16
6.6	Fill testing	16
6.7	Superintendent’s progressive approval of constructed work	16
6.8	Compaction plant	17
6.9	Drainage and dewatering	17
6.10	Topsoil surfacing	17
	Other areas	17
<b>7</b>	<b>Material requirements</b>	<b>17</b>
<b>8</b>	<b>Supply and placement of rock</b>	<b>18</b>
8.1	General	18
8.2	Rock Material Requirements	18
8.3	Rock Size and Thickness	18
8.4	Granular filter	19
8.5	Placement of Rock Beaching	19
	Stream Bank Preparation	19
	Rock Placement	20
<b>9</b>	<b>Soil amelioration</b>	<b>20</b>
<b>10</b>	<b>Reinstatement of works sites and disturbed areas</b>	<b>20</b>

## Tables

Table 1-1.	Schedule of Project Drawings	3
Table 1-2.	Schedule of hold points	4
Table 1-3.	Superintendent approval required	5
Table 5-1.	Earth fill material requirements	13
Table 8-1.	Rock Durability Requirements	18
Table 8-2.	Size Specification for Rock	19

# 1 Introduction

This technical specification sets out the technical details of the proposed Works to be undertaken for the North Wambo Creek Diversion (NWCD) Detailed Action Plan project. It deals specifically with the works associated with:

- Overland flow management which involves the construction/repair of rock lined batter chutes and associated flow management earthen bunds.
- Bank stability works in identified areas.

This specification details the standards, quality and dimensions to which the works are to be implemented. This specification is to be read in conjunction with the Project Drawings listed in Table 1-1 and the schedule of quantities in *NWCD Detailed Action Plan – Schedule of Quantities* report.

The contractor must keep a copy of the relevant specifications and Project Drawings on site at all times. Where a conflict occurs between the conditions of the Contract, Specifications and Project Drawings the order of precedence shall be as follows:

1. Conditions of Contract
2. Project Specifications (this document)
3. General Specifications
4. Project Drawings, and
5. Standard Drawings

## 1.1 Site of works

The site of works is located at Wambo Coal Mine, approximately 17 km West of Singleton in New South Wales, Australia. Wambo Coal Mine is owned and operated by Wambo Coal Pty Limited (WCPL).

## 1.2 Timing of works

Works should be undertaken during the dry season to minimise the risk of rain interruptions and potential erosion on freshly cut surfaces, where possible. Should construction take place during the wet season, controls should be put in place to minimise potential damage to people, equipment and the environment.

## 1.3 Scope of works

The scope of works is for overland flow management and bank stability works along NWCD in both the downstream portion of NWCD and the portion over LW11-LW16.

The Contractor shall supply all labour, plant, and material required to complete all earthworks and excavations shown on the Project Drawings and/or specified in the contract documents. The Work includes all clearing, carting, excavation, preparation, placement, pumping, drainage, restoration and all associated work in accordance with the Contract Documents and as may be directed by the Superintendent. All Work shall be carried out in accordance with this Specification. This document does not include revegetation works, a detailed design for revegetation will be required.

Several tasks will be required as part of the works:

- Excavation and formation of the Batter Chutes;
- Formation of the overland flow directing bunds;

The works comprise a number of tasks that should be undertaken in stages and approved prior to commencement of the next stage. The scope of work includes the following general items.

## **General**

- Mobilisation and demobilisation;
- Compliance with all mine regulations and the requirements of the Superintendent;
- Liaison and cooperation with the Superintendent;
- Survey and setting out all construction features and the extents of the Site;
- Construct all temporary access and haulage routes and re-construct all existing access as directed;
- Surface preparation including vegetation removal, topsoil stripping, removal of existing rock beaching and removal of unsuitable surface material;
- Stockpile topsoil and rock beaching in approved areas as directed;
- Excavation of the batter chutes;
- Placement of rock beaching for batter chutes;
- Stockpiling of selected materials (including rock beaching) for re-use;
- Carting to spoil materials not required for re-use;
- Topsoiling and ripping or scarifying of channel banks and restoration of disturbed areas including topsoiling.

## **Formation of batter chutes**

Formation of the batter chutes involves the removal of existing rock lined batter chutes and excavation for placement of granular filter layer and newly graded rock mix. Minor ancillary earthworks to ensure these chutes capture and convey all flow from the panels into the diversion without creating further rill/pipe/tunnel/gully erosion on the diversion batters will also be required. It should be noted that the batter drains have been designed to a detailed level, however fine detail regarding the reshaping of the area adjacent to the batter drains and diversion banks to ensure flows enter at the batter drain crests has been deferred to the construction stage as per the scope of works.

Written approval from the Superintendent shall be obtained prior to any modification of the design.

## **Ripping, soil amelioration and vegetation establishment**

These works will be specified in a separate document.

## **Site reinstatement**

All waste and surplus material resulting from the works shall be disposed of or re-used as approved by the Superintendent. Disturbed areas shall be rehabilitated to the satisfaction of the Superintendent prior to leaving the site.

## **1.4 Standards**

All works are to be carried out in accordance with current industry best practice and must comply with current, relevant standards or codes of the Standards Association of Australia.

## **1.5 Project drawings**

The Project Drawings relevant to this project are listed in Table 1-1.



**Table 1-1. Schedule of Project Drawings**

<b>DRAWING NUMBER</b>	<b>DRAWING TITLE</b>
0219016_001	SCHEDULE OF DRAWINGS AND OVERVIEW
0219016_002	BATTER CHUTES 1, 2 & 3
0219016_003	BATTER CHUTES 4, 5 & 6
0219016_004	BATTER CHUTES 7, 8 & 9
0219016_005	BATTER CHUTES 10, 11 & 12
0219016_006	BATTER CHUTE TYPICAL DETAILS
0219016_007	BATTER CHUTE SPECIFICATIONS AND DETAILS

## **1.6 Sequence of works**

The Contractor shall structure the sequence of works to minimise the need for stockpiling and excess handling of material. The staging of works for all features shall be conducted in conjunction with each other and shall cover:

- Site set out of major construction features;
- Construct all temporary access and haulage routes and re-construct all existing access as directed;
- Removal of vegetation, stripping of topsoil and removal of rock beaching and carting to stockpile or spoil;
- Formation of rock chutes and bank stabilisation works;
- Formation of flow directing bunds;
- Formation of (stockpile sites) and local fill areas;

The Contractor is to submit to the Superintendent a construction program allowing progress to be tracked against the sequence above. The Contractor may submit an alternative sequence for approval from the Superintendent.

A revegetation program is required, however is not included in this specification.

## **1.7 Hold points and inspection requirements**

Hold points are identified in this Specification by the words '**HOLD POINT**' and are summarized in Table 1-2. Works shall not proceed beyond hold points until expressly released in writing by the Superintendent.

The Contractor shall give not less than 48 hours' notice for hold points so that the Superintendent can review the submission or witness the Work process or test being undertaken and/or to undertake necessary inspections. The Contractor shall make adequate allowance in the construction program for the Superintendents' review of hold points.

Hold points may also arise from non-conformances, and the Superintendent may nominate additional hold points to be observed during construction activities.

The review by the Superintendent of a hold point does not relieve the Contractor of responsibility for satisfactory execution or performance of the work.

**Table 1-2. Schedule of hold points**

<b>Hold Point #</b>	<b>Process held</b>	<b>Details</b>	<b>Inspection by</b>	<b>Release of Hold Point</b>
1	Commencement of clearing vegetation (if required)	Set out of works – pegged limits of proposed clearing with pegs at maximum 50m intervals along the limit of clearing.	Survey & site engineer	Approval by Superintendent, verification that any features to be protected are adequately marked or protected, followed by hold point release form. Contractor signed acceptance of approved Permit to Disturb.
2	Chute excavation for review of excavation requirements in certain geologic units.	Prior to excavation.	Designer/ Site engineer	Approval by Superintendent confirmed by hold point release form.
3	Foundation preparation prior to commencement of fill placement, granular filter placement or rock placement.	Foundation surface is to be prepared in accordance with this Specification. Surface preparation varies according to material and location.	Designer/Site engineer	Approval by Superintendent confirmed by hold point release form.
4	Preparation of suitable materials prior to placement (fill, granular filter, rock beaching).	Fill materials are to be prepared in accordance with this Specification.	Designer/Site engineer	Approval by Superintendent based on inspection and field and laboratory test results. Followed by hold point release form.
5	Placement of granular filter prior to placement of rock.	Granular filter to be formed into place in accordance with this Specification where called for on the Project Drawings.	Designer/Site engineer	Approval by Superintendent confirmed by hold point release form.
6	Progressive quality assurance testing during fill/rock placement.	The test results for each stage of testing must be submitted to the Superintendent.	NA	Approval by Superintendent based on field and laboratory test results.
7	Revegetation works/ demobilisation.	Finished surface of all components.	Designer/ Site engineer	Approval by Superintendent confirmed by hold point release form.

In addition to the identified hold points, the Superintendent may inspect the Works at any time and/or at nominated milestones as in Table 1-3.

**Table 1-3. Superintendent approval required**

Clearing of vegetation

---

Surface preparation (vegetation removal, topsoil stripping and removal of unsuitable surface material) prior to excavation or filling

---

Stockpiling and re-use or disposal of cleared vegetation, waste and various materials

---

Foundation preparation – removal of unsuitable materials

---

Fill materials – control by testing

---

Supply of rock and granular filter material prior to placement

---

Prior to blasting (if required)

---

Prior to any modification of the design

---

Formation of all components prior to placement of topsoil (where required)

---

Rehabilitation of disturbed areas outside of the designed works

---

## **1.8 Survey**

The Contractor is responsible for undertaking all survey and maintaining all survey marks in their correct position. The survey requirements apply to the setting-out of the Work, conformance with the design and measurement for payment. Survey required is the extent of survey necessary to confirm that the Work conforms to the details and requirements shown on the Project Drawings and the requirements of the Specification in regard to line, length, thickness, level, position, dimension and performance.

The position, level and dimension of elements of completed Work shall be measured and recorded relative to the map grid and height datum used at Wambo Coal Mine.

### **Required Survey Locations**

The minimum survey requirements for the Work include but are not limited to:

- Base of excavation levels;
- Excavation design lines;
- Limits of Work;
- Progressive fill levels;
- Final fill levels;
- Quality Control / Quality Assurance testing locations (Easting, Northing, Reduced Level); and,
- Survey of Work as executed.

### **Differential Global Positioning Systems (DGPS)**

The use of DGPS is acceptable for both set out and control of construction plant, provided that verification survey and periodic testing of DGPS equipment is carried out to confirm the accuracy and reliability of the systems adopted.

For verification testing, bench marks established by conventional survey techniques, located with respect to the local Map Grid and level datum shall be measured for co-ordinate and level on an 'as required basis'. The results of such checking will be recorded in writing and forwarded to the Superintendent for confirmation that the set out of the Work is in agreement with the tolerances provided in this Specification.

## **1.9 Storage of materials**

The Contractor must store materials, equipment and excavated material in accordance with the requirements of the mine, local municipal council, owner or other relevant authority and this specification.

## **1.10 Protection of the environment**

The Contractor must take all necessary precautions to ensure that the environment is protected at all times.

### **Soil conservation**

All proper precautions shall be taken by the Contractor to prevent the erosion of soil by wind or water from land used or occupied by the Contractor and to prevent the deposition of soil in waterways beyond the extent of works, during and after execution of work under the Contract.

Existing vegetation and established ground surfaces shall not be disturbed unless necessary for the purpose of construction of the Works and in the accordance with the Permit to Disturb (PTD).

If in the opinion of the Superintendent the Contractor's operations cause erosion hazards, the Contractor shall undertake soil conservation measures in these areas when directed by the Superintendent. Soil conservation measures shall include, but are not limited to, stabilisation of embankment slopes and the construction of cut-off drains.

### **Fire precautions**

The Contractor shall provide, operate and maintain adequate firefighting equipment for the protection of the Works and its Construction Plant and take all necessary measures to prevent fire during the execution of work under the Contract. All reasonable measures shall be undertaken by the Contractor to protect vegetation from fire, in and adjacent the area of works arising from the Contractor's operations.

The Contractor shall comply with the requirements of the relevant Fire Authority Act and Regulations made there under, and ensure that all persons on the Site observe these requirements.

The Contractor shall take notice, and implement appropriate strategies, of any announcements by the Country Fire Authority (or equivalent), particularly the notification of days of Total Fire Ban.

### **Control of surface water runoff**

All necessary measures, including design, supply, installation, maintenance and operation of drainage systems, shall be implemented by the Contractor to manage surface water from the works area reporting to the environment beyond the works area consistent with the mines Environmental Authority.

### **Preservation of flora and fauna**

The Contractor shall not destroy, remove or clear trees and vegetation without the prior written permission of the Superintendent.

All necessary measures shall be taken by the Contractor to prevent its employees and subcontractors from hunting, disturbing, capturing or destroying animals and birds or their breeding places within the site and all neighbouring areas and along the accesses to the site.

The Contractor must not damage, clear or cut back vegetation more than is necessary to enable construction of the Works. Construction of the Works shall be undertaken in a manner that minimises disturbance to existing vegetation.

### **Flora debris**

Whenever clearing is required under the Contract selected trees, stumps, roots and brush shall be stockpiled for use in rehabilitation of the diversion. Burning of material will not be permitted unless otherwise approved in writing by the Superintendent.

### **1.11 Fencing**

The Contractor shall arrange for and erect any necessary fencing around the Works to maintain a safe environment, and where necessary, to keep livestock from the construction Site.

### **1.12 Safety**

The Contractor shall comply with all safety requirements of Wambo Coal Mine and comply with all relevant safety standards required by Statutory Authorities having jurisdiction over all or part of the works.

### **1.13 Permit to disturb**

An approved Permit to disturb from the Superintendent is required for any excavation. The Contractor shall request such permits from the Superintendent, in writing, not less than five (5) working days before commencing any excavation. The request shall detail the location and the size of the area to be excavated and the planned commencement and completion date. The planned excavation shall not be commenced until the Superintendent's written approval has been obtained.

### **1.14 Utilities**

The Superintendent will work with the Contractor to establish the location and extent of any buried utilities. The Contractor shall immediately cease work and inform the Superintendent when unknown utilities are encountered, or if utilities are not located as indicated in the excavation permit. The Contractor shall record the position and elevation by survey of all existing, re-routed and abandoned service lines encountered in the Work.

Damage caused by Contractor negligence shall be satisfactorily repaired at no cost to the Superintendent.

Superintendent-approved isolation/lock-out procedures (energy isolation) shall be used around live systems, and must be coordinated with the Superintendent.

### **1.15 Definitions and interpretations**

The following definitions and interpretations shall apply to this Technical Specification:

- The Project means the total construction contemplated of which the Work may be the whole or part.
- The Work means the total construction and related services required by the Contract Documents.
- Superintendent means Wambo Coal Mine's appointed representative in charge of the Work and duly authorized to act on Wambo Coal Mine's behalf.
- Owner's Representative means a person, group of persons or corporate entity designated by the Principal who is authorized to represent the interests and make decisions on behalf of the Principal for the Work.
- Words importing the singular shall include the plural and vice versa and words importing the masculine gender shall include the feminine and words importing persons shall include bodies corporate.
- Plant means, as distinguished from Work, anything and everything, except persons, used by the Contractor in the performance of the Work.
- Site means the place where the work is being performed and the immediate vicinity thereof.
- Where the words shown, indicated, detailed, specified, or words of a similar import are used, such words shall refer to the Specifications and/or Project Drawings unless expressly stated otherwise.

- Drawing means all drawings, plans, sketches and maps issued with the Specifications or subsequently as provided for in the Contract and includes any drawings submitted by the Contractor if signed as approved by the Superintendent.
- Project drawing means those drawings listed in section 1.5 of this specification.
- Where the words directed, permitted, approved, accepted, required, satisfactory, rejected or words of similar import are used such words shall refer to the direction, permission, approval, acceptance, requirements, satisfaction or rejection in writing by the Superintendent unless expressly stated otherwise.
- Environmental Management System (EMS) means the Superintendent's environmental standards and procedures for management, reporting, and compliance with applicable environmental regulations.
- Embankment means earthen plug, earthen levee and/or earthen embankment.
- Inspection by Survey for hold points means the contractor shall survey the work item[s] being considered for compliance with the design and submit to the Superintendent for approval.
- Inspection by Site Engineer for hold points means an engineer appointed by the Superintendent.
- Inspection by Designer means a person appointed by the company who designed the project.
- Inspection by Geotechnical engineer means the certifying geotechnical engineer appointed by the Superintendent.

## **2 Codes and standards**

Unless otherwise approved or specified, the workmanship, equipment and materials shall comply with the latest revision (including the latest addenda prior to the date of submission of the bid) of this Specification and the relevant Australian Standards together with the requirements of Statutory Authorities having jurisdiction over all or part of the works. Where conflict exists between different applicable codes, standards or regulations the higher requirement shall apply. No deviation from the provisions of the relevant standard is permitted without first obtaining approval in writing from the Superintendent.

## **3 Control of water and sediment**

All works shall comply with the site Sediment and Erosion Control Plan and Environmental Authority where there is potential risk to discharge sediment off mine lease and/or into a waterway beyond the extent of works. Slopes, crowns and drains shall be provided and maintained by the Contractor on all excavations and fills to ensure satisfactory drainage at all times. Culverts, catch drains, ditches, sumps, silt traps, sediment basins, settling areas and other facilities shall be provided by the Contractor and maintained to control the stormwater runoff on, over and from the site, to control erosion, and to prevent damage to, or fouling of work in progress or completed.

Sediment settling structures and other debris collecting structure shall be cleaned out by the Contractor as directed by the Superintendent.

All necessary pumping equipment for controlling runoff and ponding during storms and dewatering the surfaces surrounding excavations and in foundations shall be provided, by the Contractor, on site in working order at all times.

Repairs by the Contractor to damage caused by stormwater runoff form part of the requirements of this specification.

## 4 Site preparation

Site preparation is the responsibility of the Contractor and must be completed and approved by the Superintendent prior to Works being undertaken.

### 4.1 Set out of works

Works shall be set out in accordance with the Project Drawings, digital design strings and these specifications and shall be approved by the Superintendent prior to Works being undertaken.

Existing levels including any variations from those shown on the Project Drawings and digital design strings shall be verified with the Superintendent prior to commencement of work.

The position and level of Works including the placement of benchmarks, controls and offset pegs; the set out of embankment toes and alignment of structures and limits of Work shall be established by the Contractor and approved by the Superintendent prior to the commencement of Works. Line and level pegs shall be positioned as required to ensure accuracy and control of the earthworks undertaken. The Contractor is responsible for maintaining, offsetting and placing additional pegs and must ensure offset pegs are adequately protected.

The Superintendent may request details of offset and construction pegs, in writing, and may periodically check construction levels and set out at any time during construction.

#### **Set out – for clearing and grubbing of vegetation, removal of existing rock beaching and stripping of topsoil**

The set out of any section of work shall be pegged by the Contractor not less than 48 hours prior to commencement of clearing. Pegs at maximum 50 m intervals shall be established along the limits of the proposed clearing. The Contractor shall notify the Superintendent when the proposed clearing limits have been pegged and are ready for approval by the Superintendent.

**HOLD POINT 1** – The Superintendent will inspect and approve the set out and any required permits before any clearing can commence.

#### **Set out – for excavation (all components)**

The set out of any section of excavation shall be pegged by the Contractor not less than 48 hours prior to commencement of excavation. Pegs at intervals as required to ensure accuracy and control of the excavation and maximum 50 m intervals shall be established along the construction control lines, embankment toes and batter tops and limits of the proposed excavation. The Contractor shall notify the Superintendent when the proposed excavation limits have been pegged and are ready for approval by the Superintendent.

**HOLD POINT 2** – The Superintendent will inspect and approve the set out of any required excavation and issue an approved permit to dig before any excavation can commence.

### 4.2 Clearing and grubbing of vegetation

Removal of vegetation shall be undertaken in accordance with any permit conditions and in a manner that will avoid damage to other vegetation or property outside the area to be cleared.

Approval for clearing of vegetation shall also be obtained from the Superintendent and/or relevant authorities (if required) and copies of all related permits provided to the Superintendent for approval prior to any vegetation removal.

#### **Extent of clearing**

The areas where any works are to commence shall be cleared and grubbed to a minimum width of 3m margin outside the area of works, or as specified by the Superintendent.



The extent of clearing shall be restricted to the minimum required to undertake the works safely and without negatively impacting on the works and adjacent areas. The area to be cleared shall be agreed upon by all relevant parties prior to clearing going ahead. Clearing outside the approved areas shall not be permitted without the Superintendents prior written approval.

### **Clearing**

Clearing of vegetation shall be undertaken by suitably qualified persons in accordance with permit conditions, and in a manner that satisfies safety requirements of the mine site.

### **Disposal of cleared vegetation**

Disposal of cleared vegetation shall be in accordance with relevant conditions of vegetation clearing approvals and mine site regulations. Cleared vegetation can be re-used as part of rehabilitation works for the diversions in the form of mulch, strategically placed logs and general habitat and organic matter provision in accordance with the revegetation plan.

## **4.3 Stripping and stockpiling of topsoil and rock beaching**

Topsoil shall be stripped from all work areas and stockpiled in accordance with this specification. All work areas shall be stripped of topsoil to a nominal depth of 300 mm or otherwise as directed by the Superintendent to ensure no significant visible organic matter is retained and to ensure no mixing of topsoil with the subsoil occurs. The part of the stripped material that contains significant visible organic matter shall be stockpiled separately for potential re-use as topsoil surfacing.

Stripped topsoil shall be stockpiled clear of the earthworks and all other Works areas as directed and approved by the Superintendent for later reuse. Topsoil stockpiles shall be positioned and shaped in such a way to minimise erosion. Adequate drainage shall be provided to minimise sediment mobilisation. The height of topsoil stockpiles shall not exceed 3.0 metres unless approved in writing by the Superintendent.

If the topsoil is to be stored for longer than 3 months it is recommended the stockpiles are grass seeded.

Rock beaching shall be removed and stockpiled for re-use in rock lined batter chute construction if suitably graded.

## **5 Earthworks**

Earthworks shall not be undertaken by the Contractor until the Superintendent has approved site preparation.

**HOLD POINT 2** – The Superintendent will inspect and approve the set out and any required permits before any excavation can commence.

### **5.1 General**

Earthworks shall be formed to the lines and levels specified in this technical specification and on the Project Drawings and digital design strings. Written approval from the Superintendent must be received by the Contractor prior to implementation of any proposed modifications to the design presented on the Project Drawings, digital design strings or detailed in this specification. All earthworks shall be finished to be free draining surfaces and left rough, unless specified otherwise.

### **5.2 Tolerances**

Earthworks, including excavation and the placement of select fill and topsoil, shall conform to the dimensions and grades shown on the Project Drawings, digital design strings and detailed in this specification.

Longitudinal gradients of batter drains shall not differ by more than 10 % from the design grade.

Construction that varies from the above tolerances must be approved, in writing, by the Superintendent.

### 5.3 Excavation

Excavation shall consist of removal and satisfactory disposal (or stockpiling) of all materials from within the limits of the excavation Works. Excavation shall be undertaken to shape the area to the design surface, forming the desired slopes, widths and elevations as shown on the Project Drawings and digital design strings with allowance for the placement of materials including, but not limited to, rock and granular filter material. The Superintendent may direct the re-use of materials and the appropriate stockpiling of them. Excess cut material shall be disposed at the nearest suitable site identified and approved by the Superintendent.

Unsuitable material including, but not limited to, roots, decaying vegetation and unstable soils shall be removed from the excavation at the direction of the Superintendent. Where removal of such material extends beyond the design surface the design surface shall be reinstated with a suitable material (including moisture conditioning and compaction where necessary) to the satisfaction of the Superintendent.

Excavation shall be undertaken in a manner that minimises disturbance to material outside the limits of the batters.

**HOLD POINT 2** – The Superintendent will inspect and approve the set out of any required excavation and issue an approved permit to disturb before any excavation can commence.

### 5.4 Materials

Material to be excavated is suggested to be classified as rippable or non-rippable.

#### ***Common excavation***

Common excavation refers to all materials including vegetal material, peat and organic soil, clay, silt, sand and gravel, boulders and loose rock smaller than 1,000 mm average diameter or weathered rock that is classified as rippable.

Common materials shall be excavated from the Work area to the approved depths and limits. Unsuitable materials encountered in the excavations that exist prior to construction or develop during construction shall be excavated, hauled to the designated disposal areas and replaced with approved fill meeting the minimum Specification.

#### ***Materials segregation***

Materials encountered as part of the Works, including materials uncovered during vegetation clearing, topsoil stripping and excavation, and imported materials, shall be separated as follows:

- Selected timber may be retained, under direction of the Superintendent, for possible re-use in providing general habitat features within the Works area including in stream channels where appropriate;
- Topsoil is to be stripped from all Works areas and stockpiled for future use in covering disturbed surfaces such as, channel banks, placed fill, rock beaching and batter drains;
- Selected material that meets the requirements of this Specification may be used for embankment construction or replacement of unsuitable material where approved by the Superintendent;
- Rock uncovered as part of the Works should be stockpiled and re-used as rock fill, beaching, rock/rubble, rock-soil mix or any other use approved by the Superintendent; and
- Materials imported from outside the Works area should be stockpiled in separate piles to materials encountered on site, unless directed otherwise by the Superintendent.

#### **Fill materials**

The Superintendent shall make available materials from nominated borrow areas. The Superintendent makes no representation as to the suitability or otherwise of the materials in the borrow areas for use within the Work. Selection and processing of materials from the borrow areas to meet the requirements of the

Specification is the responsibility of the Contractor. Borrow materials should be sourced from the diversion excavation material.

**Unsuitable fill materials**

The following fill materials shall not be used in the Work:

- Organic soil (topsoil) and vegetal materials;
- Silts, or materials that have the deleterious engineering properties of silt;
- Metal, timber; plastic, organic clays and silts, fly ash, and the like;
- Building waste or other such material;
- Material deemed deleterious by the Superintendent;
- Material which is too wet or too dry to achieve the required level of compaction;
- Materials which have been contaminated with fuels or other pollutants;
- Materials that for any other reason do not meet the minimum Specification.

Soil meeting the minimum requirements for fill but unsuitable for immediate use due to high moisture content may be temporarily stockpiled and dried for later use.

**Earth fill materials**

All earth fill suitable for the general fill areas shall comply with the requirements of this specification. The Contractor shall confirm to their satisfaction prior to bidding that sufficient materials are available. Material requirements are provided in Table 5-1.

**Table 5-1. Earth fill material requirements**

Property	Criteria
Soil description	Clay and/or sandy clay/clayey sand
Maximum Size <sup>1</sup>	25 mm
% Passing 75 µm Sieve <sup>1</sup>	>20
Plasticity index <sup>2</sup>	7-40%
Liquid Limit <sup>3</sup>	25-45%
Emerson Class	N/A
Pinhole dispersion (PD)	N/A
Exchangeable sodium percentage (ESP)	N/A
1	Procedure AS1289.3.6.1 – 2009
2	Procedure AS1289.3.3.1 – 2009
3	Procedure AS1289.3.1.1 – 2009



## 5.5 Excavation methods

The Contractor shall conform to the following general guidelines for all excavation activities:

- Develop excavation methods, techniques, and procedures with consideration for safety, environmental hazards and the nature of materials to be excavated.
- Take precautions to preserve in an undisturbed condition all materials outside the excavation lines. All slips of insecure masses of materials outside the limits of excavations and specified cut batters shall be removed and reinstated by the Contractor in a manner approved by the Superintendent.
- Avoid excavation beyond the excavation lines shown on the Project Drawings and any permit to disturb unless otherwise approved by the Superintendent.
- Dispose of all excavated material in the areas designated and approved by the Superintendent. Under no circumstance shall water, soil, rock, or deemed contaminated material be discharged, ponded, or stockpiled outside of the Site or approved areas.
- The construction of temporary roads, ramps, or fills to allow equipment access to certain areas could be required. Such requirements shall be identified by the Contractor and submitted to the Superintendent for approval before starting the excavation. The Contractor shall be responsible for construction, deconstruction, and safe disposal in approved areas of all temporary structures.

## 5.6 Removal of unsuitable material

Soft, wet or unstable areas of material that extend below design levels, which exist or develop during construction, shall be excavated and replaced with approved materials in layers not exceeding 200 mm loose thickness, moisture conditioned as required and compacted as directed in writing by the Superintendent.

## 5.7 Spoil dumps

Excess excavated material not required for construction of the works shall be dumped to form permanent spoil dumps in locations approved by the Superintendent. The spoil dumps shall be designed and constructed in accordance with Wambo Coals Mine's standards.

## 5.8 Stockpiles

Where necessary, the Contractor shall stockpile various materials for future use including materials recovered during clearing and excavation. Different materials shall be stockpiled separately and materials excavated from different areas of the site shall not be mixed unless required to meet specification. Materials to be stockpiled include sand and gravels, topsoil, clay, silt, identified imported fill, rock and imported rock, in designated areas approved by the Superintendent.

Stockpiles must be kept clear of hazard areas and shall be located out of the way of Works and away from watercourses or any associated drainage lines at sites approved by the Superintendent.

Areas designated for stockpiling of materials shall be determined as part of the construction sequence to be approved by the Superintendent prior to commencement of Works.

Stockpiles shall be formed such that they minimise erosion of material during any rainfall events in the construction period. Prior to stockpiling material, designated areas shall be cleared of vegetation as per Section 4 of this specification.

Prior to stockpiling clay material, the designated area shall be stripped down to a lower level, approved by the Superintendent, to minimise contamination during subsequent excavation of stockpiles.

Stockpiles of topsoil shall be no more than 3.0 m in height. If topsoil is to be stored for longer than 3 months, the stockpiles are suggested to be grass seeded.

## 5.9 Blasting

If blasting is required all necessary permits applicable under the mine and statutory regulations must be obtained and copies provided to the Superintendent prior to any blasting being undertaken. The Contractor must comply with the conditions of the blasting permit/s and the following Acts and Standards:

- Mining and Quarrying Safety and Health Regulation 2001
- Explosives Act 1999
- Explosives Regulation 2003
- AS 2187.0 -1998 Explosives - Storage, transport and use
- AS 2187.1-1998: Explosives – Storage and use; Part 1: Storage
- AS 2187.1-1998/Amdt 1-2000: Explosives – Storage and use; Part 1: Storage
- AS 2187.2 - 2006: Explosives – Storage and use; Part 2: Use of explosives
- AEISG Code of Practice - Precursors for Explosives 1999. (Australian Explosives Industry Safety Group)
- Australian Explosive Code (AEC) – Australian Code for the transport of explosives by Road and Rail, 2nd Ed Mar 2000
- Australian Dangerous Goods Code (ADG)
- Dangerous Goods Safety Management Act 2001
- Dangerous Goods Safety Management Regulation 2001
- AS 4326-2008: The storage and handling of oxidizing agents
- Security Sensitive Ammonium Nitrate Guidance Notes
- All applicable regulations of the municipality in which the blasting operations are being carried out, regarding the use of explosives, and
- Any other statutory regulations that may apply.

This list is not comprehensive and does not override any Ensham Mine standard operating procedures regarding the use of explosives. The Contractor is liable for any accident, injury or damage resulting from the use of explosives.

## 6 Filling

Where shown on the Project Drawings, fill material shall be placed, moisture conditioned and compacted, as required, in accordance with the following specifications.

### 6.1 General

Fill shall not be placed in any area until clearing; excavation and surface preparation have been carried out and approved in writing by the Superintendent.

### 6.2 Approval by Superintendent

No fill material shall be placed in any section of the Work until the material beneath that section has been suitably prepared and has been approved by the Superintendent.

**HOLD POINT 3** - The Superintendent will provide written approval of the prepared founding surfaces before filling can commence.

### 6.3 Placement of fill

Earth fill shall be placed in continuous approximately horizontal layers for the full width of the filled area and having a thickness not greater than 300 mm loose (before compaction), except as otherwise approved by the Superintendent. Each layer placed shall be scarified in an approved manner to provide a satisfactory bonding surface with the overlying layer.

The Contractor shall for all materials mark the proposed layer thicknesses at intervals of not less than 50m for each material being placed. The method of marking shall be in the form of clearly visible marks such as pegs-and-flags or spray paint markings indicating the proposed layer thickness. The Contractor is responsible for constructing to Specification within the lines and levels indicated in the Project Drawings.

### 6.4 Moisture Conditioning

The Contractor is to pump or transport water for use in moisture conditioning of soil. The Contractor is to supply all equipment necessary for pumping and transport of water to moisture condition soils. The Superintendent will nominate a suitable source of water, located within the mine lease boundaries.

The moisture conditioning of the embankment fill materials must be done as a separate phase prior to placing the fill; moisture conditioning after placement shall be rejected.

Moisture conditioning of excavated materials shall be carried out in the borrow pits or in an approved area purpose-built for this purpose.

### 6.5 Compaction and Moisture Content Criteria

Each layer of material shall be compacted with a 12 tonne (minimum) pad foot roller until the field density, as determined by the Superintendent, meets the following criteria:

- 95% of the Maximum Dry Density obtained from the standard compaction test method carried out in accordance with AS 1289 5.4.1-1993.
- A moisture content between -2% to +2% of Standard Optimum Moisture Content (OMC) as determined in accordance with AS 1289 5.7.1-1993.

The material in each layer shall have uniform moisture content throughout within the specified range. The compacted fill shall be consistently dense and moist throughout and free from lenses, pockets, laminations, streaks, continuous planes of weakness, large open voids and areas of varying moisture content or density.

### 6.6 Fill testing

Testing of earth fill shall be carried out by the Contractor at a frequency detailed below and in accordance with the relevant Australian Standards:

- In-situ density: not less than one test for every 2,000 m<sup>3</sup> placed and for each layer placed;
- Moisture content: not less than one test for every 2,000 m<sup>3</sup> placed and for each layer placed;

The testing must be completed in accordance with the relevant Australian Standards. All test data must be recorded and stored as part of the construction quality assurance.

### 6.7 Superintendent's progressive approval of constructed work

The suitability of each section of the constructed works for placing further embankment materials thereon and for all other materials for use in the embankment construction shall be progressively determined by the Contractor and approved by the Superintendent.

The Contractor will report all tests including failed tests to the Superintendent. No materials shall be placed on the constructed works prior to the Superintendent's written notification of approval of that section of the Work.

The Superintendent will approve material placement as construction continues (**HOLD POINT A5**).

### **6.8 Compaction plant**

The Contractor shall provide and operate appropriate equipment to compact materials to the specified compaction standards. All equipment will need to meet Ensham Mine requirements for site compliance.

### **6.9 Drainage and dewatering**

Where excavation and filling is specified on the Project Drawings, the Contractor shall be responsible for the effective removal and conveyance of all water and sludge from such areas in such a manner as not to cause any nuisance or injury to property or persons.

Earthworks shall be kept clear of water at all times, either through provision of pumped or gravity drainage systems.

The Contractor shall at all times during the progress of the work, construct and maintain such temporary drains, pumps and other equipment necessary to protect the Works. The Contractor must control discharges to watercourses or drains so that they comply with mine and/or DEHP requirements.

No ponding of surface water is permitted within 15m of the top of diversion batters due to the risk of tunnel erosion in dispersive soils.

No concentration of overland flow or minor tributary inlet is allowed that will create rills/gullies in diversion batters during or after works.

### **6.10 Topsoil surfacing**

Following topsoil placement of approximately 300mm, the finished surface shall be ripped to a minimum depth of 600 mm where substrate allows, approximate the grade and shape of the design surface, be free draining and left rough. The 300mm topsoil thickness may be made of a blend of topsoil and rubble of erosion resistant materials won from excavation such as laterite/indurated Tertiary sediments.

No topsoil surfacing is required on the upper batter if it is steepened to 1V:1H where erosion resistant indurated sediments are encountered in the upper profile.

#### **Other areas**

All other areas disturbed by the construction activities but not specifically designated for topsoiling on the Project Drawings or in this specification shall be graded to form a uniform slope and covered with topsoil to a minimum thickness of 150 mm, ripped to a minimum depth of 300 mm and left rough with no concentration of overland flow entry or ponding within 15m of top of diversion batter.

## **7 Material requirements**

The Contractor shall provide the Superintendent with a certified test report showing that the material requirements meet the details outlined in this specification.

**HOLD POINT 4** – Materials to be approved by Superintendent based on inspection and field and laboratory test results prior to placement.

Fill material requirements to be determined by the Superintendent if filling is required.

## 8 Supply and placement of rock

### 8.1 General

The supply, delivery and placement of rock shall be in accordance with this specification and the Project Drawings.

### 8.2 Rock Material Requirements

Rock used for beaching or in chutes shall be hard, durable, angular in shape, and free from cracks, overburden, shale and organic matter. Thin, slab-type stones, rounded stones and flaking rock shall not be used. Rock should not be adversely affected by repeated wetting and drying and shall have a crushing strength of not less than 25 MPa.

The 50-percentile size has been specified and is defined as the 'D<sub>50</sub>', meaning that 50% of the rock blend must pass through a sieve of that nominated size. The size specification is shown in Table 8-2. The grading is given to ensure that a well graded rock mix is obtained so that the rock will interlock and have low void spaces that will seal with time. Poor grading is to be avoided as it will increase the potential for structure failure. Hence the rock mix should not be single sized, but be a well graded mixture that will ensure that all interstices between large rocks are able to be filled with rock of progressively smaller size. This has the combined effect of:

- Ensuring that no significant voids occur in the rock blanket through which the underlying materials can be washed out.
- Creating an interlocking mass of rock in which no individual rock is free to move by itself.
- Creating a shielding effect on the surface of the rock, avoiding high drag forces which occur when individual rocks excessively protrude into the flow (hence oversized rocks are not permitted).

Rock used for beaching or in chutes shall meet the durability requirement listed in Table 8-1 when tested in accordance with the specified procedures. The Contractor shall furnish the Superintendent with a certified test report showing that the rock meets these requirements. Service records of the proposed material may also be considered by the Superintendent, in determining the acceptability of the rock.

**Table 8-1. Rock Durability Requirements**

Test	Requirement
<i>Relative Density</i> (density of dry solid rock relative to water)	Minimum of 2.5
<b>Abrasion (Abrasive Grading A)</b> Los Angeles Abrasion Test. (AS 1141.23)	Less than 40% loss of weight after 500 revs.

### 8.3 Rock Size and Thickness

The size of rock to be used for riprap or beaching shall have a D<sub>50</sub> as specified on the Project Drawings. Classifications and gradations for the rock are shown in Table 4.2. The maximum stone size shall not be larger than the thickness of the designed rock layer. Neither breadth nor thickness of a single stone shall be less than one-third its length.

The rock shall be a well-graded mixture designed to ensure that all interstices between larger rocks are filled with rock of progressively smaller size. Notwithstanding the grading given in Table 8-2, the grading of the rock shall be such as to produce a blanket of interlocking rock that is devoid of significant voids and that will provide bed and bank soils with a shielding surface able to withstand high stream flows.



**Table 8-2. Size Specification for Rock**

Equivalent "sieve" size	Percentage (by weight) finer
2 times $D_{50}$	100%
$D_{50}$	50%
0.3 x $D_{50}$	10%

Note:  $D_{50}$  = median particle size. (50% of the mass shall consist of stones with an equivalent spherical diameter\* equal to or larger than this dimension). \*The diameter of a sphere with an equivalent volume to the individual rock.

#### **8.4 Granular filter**

A granular filter layer shall be of the nominal size indicated on the Project Drawings. Durability and other requirements shall satisfy the requirements of this specification as it relates to  $D_{50}$  graded material.

A 150mm thick granular filter layer of crushed rock shall be placed at all rock to soil interfaces. The granular filter layer shall generally be placed and compacted by machine bucket to provide an even surface.

**HOLD POINT 5** – The Superintendent will inspect and approve the placement of granular filter prior to the placement of rock.

#### **8.5 Placement of Rock Beaching**

Where indicated on the drawings or directed by the Designer, the Contractor shall protect sections of stream bank with riprap or rock beaching placed in accordance with the requirements of this specification and associated drawings.

The Contractor shall use methods for handling and placement of rock that will avoid segregation of the rock size fractions.

Rock shall be carefully placed by bucket from a loader or excavator from no greater than 1.0 m above the material onto which it is to be placed. Placement of rock shall be such as to produce a blanket of interlocking rock that has no significant voids.

Voids in the blanket of rock which, in the opinion of the Superintendent, place the structural integrity of the chute at risk shall be reworked to the satisfaction of the Superintendent.

No rock shall be placed until the preparation of the site has been approved by the superintendent. Where a granular filter or geotextile is used no rock shall be placed until placement and formation of the material has been approved by the superintendent.

#### **Stream Bank Preparation**

Where stream bank protection is required by the drawings, the Contractor shall excavate or fill such that the finished surface including rock beaching matches the lines and levels shown on the drawings.

All earthworks shall be carried out in a manner that minimises the mobilisation of potential erosion products.

To achieve the required natural channel effect, the Contractor shall vary the bank slopes between the general limits shown on the Drawings.

Rock beaching on the bank is to be installed in manageable sections, wherein the rock is placed on the bank on the same day that the excavation is undertaken. At the completion of each day's work all toe excavations must be backfilled with rock beaching.

## **Rock Placement**

The Contractor shall not place any rock until the Superintendent approves the excavations.

The rock shall be placed on the embankment to the thickness and grade shown on the drawings. The finished surface shall be evenly sloped, conforming to the contour required (the maximum angle of repose being 42 degrees). Where the drawings stipulate that variations in surface profile of the riprap are required (for the purpose of providing variable habitat conditions), the Contractor shall modify the placement process so that larger pieces of rock are placed with a portion protruding above the general riprap profile, as well as providing for some undulation in the surface profile.

The rock riprap shall be placed in a manner that will produce a well graded, interlocking mass of riprap with a minimum amount of voids.

A granular filter layer, as specified in the Project Drawings and in Section 4.2, shall be placed on the prepared sub grade.

The Contractor shall use methods for handling and placement of the rock that will avoid segregation of the rock size fractions. Rock shall be carefully placed by the bucket from a loader or excavator. Rock placing by dumping directly from a dump truck will not be permitted.

Voids in the blanket of rock that expose the subgrade shall be packed with smaller rock by suitable methods such that, in the opinion of the Superintendent, this method can produce a shielding surface of interlocking rock and the structural integrity of the rock blanket is not at risk. If, in the opinion of the Superintendent, the extent of voids in the blanket of rock is such that the structural integrity of the rock blanket is at risk, the Superintendent shall direct that that section of rockwork be reworked.

At the toe of embankments the Contractor shall key all rockwork closely so as to improve the stability of the toe against erosion as detailed in the accompanying construction drawing set.

**HOLD POINT 6** – The Superintendent will inspect and approve the quality and placement of rock.

## **9 Soil amelioration**

Specified in separate document.

## **10 Reinstatement of works sites and disturbed areas**

The Contractor is responsible for reinstatement of the Works site and all other areas disturbed as a result of the works including access tracks.

Reinstatement may include grading or filling of areas to match adjacent undisturbed surface levels.

All such areas shall be topsoiled, ripped and revegetated in accordance with the quantities and detail design plan, this specification and approved by the superintendent. No overland flow will be concentrated over diversion batters and no areas of ponding will be left within 15m of top of diversion batters.

Where the contractor uses existing access tracks these shall be maintained throughout the Works and, at the end of the Works, be reinstated to a minimum condition that is similar to that prior to the start of Works.

**HOLD POINT 7** – The Superintendent will inspect and approve the finished surface of all reinstated sites and issue a hold point release form before demobilisation can commence.

# **APPENDIX D NWCD REVEGETATION MANAGEMENT PLAN**

# North Wambo Creek Diversion Revegetation Management Plan

Prepared by **Cumberland Plain Seeds**  
for Wambo Coal mine and Soil Conservation Service  
August 2019



Authors: John Moen & Tim Berryman



## Contents

Introduction.....	3
Target vegetation.....	3
Direct seeding – species selection.....	5
Seed collecting.....	6
Direct seeding methods.....	6
Mechanical broadcasting/ Hand broadcasting.....	7
Hydromulching/Hydroseeding in steep or inaccessible areas	9
Placing and seeding of erosion controls.....	10
Planting procedure.....	11
Site monitoring and performance criteria.....	12
Visual monitoring.....	12
Landscape Function Analysis monitoring.....	12
Floristic monitoring.....	12
Trigger Action Response Plans.....	14
Appendix 1. Revegetation species list.....	15
Appendix 2. References.....	17



Early establishment of diverse grassy woodland at Mount Thorley Mine, NSW.

## Introduction

This document has been prepared in conjunction with Soil Conservation Service's North Wambo Creek Diversion Stability Assessment and Remediation Proposal. Cumberland Plain Seeds has been commissioned by Soil Conservation Service (SCS) to develop a plan for revegetation works of a section of the North Wambo Creek Diversion (NWCD). The revegetation will take place after reshaping and remediation of the Trial Section of the NWCD.

This plan proposes a method for establishing native vegetation on the site which resembles the local native plant communities close by. Performance criteria and a monitoring protocol are also included to aid in assessing the revegetation works and identifying potential problems.

## Target vegetation

The North Wambo Creek diversion was initially intended to be revegetated using riparian species native to the local area. However, much of the constructed creek line has become unsuitable for riparian vegetation establishment due to changes in soil type and water flow. It would therefore be more appropriate to establish a woodland vegetation type on the majority of the creek diversion site. Some areas of the creek may remain suitable for the establishment of riparian vegetation, particularly where the creek profile will slow water flow and therefore increase the availability of moisture.

These areas will be identified once the final landform is constructed and based on data provided in hydrological reports. Revegetation in areas identified as potential habitat for riparian species should be done with a species mix which includes both riparian and woodland species. Riparian plants included in the revegetation species list are hardy species which should be able to establish in areas with limited water availability.

If riparian species prove successful in these areas they will provide important islands of riparian vegetation. These islands may in time expand as the hydrology and soil characteristics of the creek line change. A detailed revegetation species list is included in Appendix 1.

The majority of the site should be sown using a variety of direct seeding methods. Although seed costs are much higher, this method of revegetation has several advantages over tube stock planting:

- Plants growing from seed in situ develop a robust root system before devoting resources to vegetative growth, resulting in a hardier plant which can better withstand heat and drought early in the establishment phase.
- Plants grow in the niche best suited to them – seed only germinates when it encounters the right combination of soil type, depth, temperature and moisture.
- It is much easier to establish plants at high density – 10-20 plants/m<sup>2</sup> (Trees, shrubs and herbs) is quite achievable.
- Installation and maintenance watering requirements are much lower, although irrigation is useful to assist establishment
- Labour costs for sowing are significantly lower than for planting.

Planting of tube stock in selected areas may also be appropriate. Tube stock can be useful in areas where higher water flows or steep slopes decrease soil stability and therefore the potential for seed to germinate. Tube stock may also be useful in increasing understorey species diversity once a canopy and shrub layer have been established. Planted tube stock must be given enough water to ensure survival.

Establishing native vegetation on this site presents many challenges. The soil conditions at the site are currently unknown and it is difficult to predict the behaviour of the exposed dispersive subsoil and the ability of native species to establish in such a medium. Soil amelioration will improve the quality and chance of success.

Exotic species currently present on the site pose a second challenge. Competition from exotic species, particularly perennial grasses and *Galenia pubescens* will potentially provide significant competition to native species.



Thirdly the prevailing climatic conditions were particularly difficult in the 3 years preceding 2019. For example 2018 rainfall totals for NSW were 40% below average, Autumn 2019 rainfall was 32% below average and Summer 2019 rainfall was 48% below average (BOM 2019).

These challenges will make it particularly important to focus on the following:

- good soil analysis and amelioration
- appropriate species selection and sourcing high quality seed
- ground preparation
- weed control both before and after sowing
- monitoring and adaptive management (see performance criteria for further details)

## North Wambo Creek Diversion revegetation concept plan



-  Woodland
-  Salt tolerant vegetation
-  Riparian Vegetation

DigitalGlobe | Esri, HERE, Garmin

Note: This map is a concept plan only, drawn after a brief site inspection. Detailed mapping of the revegetation site will be done following re-shaping and soil amelioration.

## Direct seeding – species selection

The focus of this seed mix should be on primary and secondary colonising species which can establish in harsh conditions. The conditions prevailing on the rehabilitation areas will be ones of high light, heat, relatively low moisture and potentially intense competition. The soil type does not conform to those normally supporting local vegetation communities (e.g. absence of an A horizon, exposed subsoil and bedrock).

Initial soil test results show that there are several potential problems with the soil on site. Soils vary but salinity and sodicity along with high pH appear to be the key problems. The addition of organic material in the form of mulches and composts should help both stabilise the soil, decrease pH and provide a better growing medium for natives. Salinity will be difficult to combat in the short term and the focus in areas affected by salinity should be to sow salt-tolerant species. Further soil testing may be warranted to assist in mapping soil type and matching species best suited to each situation.

Native seed require a stable niche with good soil contact and appropriate sowing depth in order to germinate. They need sufficient moisture to germinate and a gap relatively free from competition. They may also require particular soil conditions - pH, salinity, availability of certain nutrients – to establish on a given site. However, once germinated these species are usually able to cope well with heat and drought and compete effectively with many exotic plants.

Species selected for direct seeding, listed in Appendix 1, are based on their success rates in similar rehabilitation situations. Consideration is also given to the local availability of seed in direct-seeding quantities.

Once native vegetation is re-established on the site it will have characteristics of several vegetation communities identified in the Wambo Coal Mine Biodiversity Management Plan, in particular River Red Gum/ River Oak riparian woodland wetland in the Hunter Valley and Narrow-leaved Ironbark– Grey Box – spotted gum shrub grass open forest of the central and lower hunter. It is important to note that in the early stages of any rehabilitation program the young vegetation will not closely resemble that of a target vegetation community. Any vegetation assemblage colonising a bare site will be quite different in assemblage from any analogue reference site.



Native seedling establishment, Hungerford Creek NSW



Some additional species not listed in the Biodiversity Management Plan have been added to the list for direct seeding. They are all species which occur in local plant communities and may be sourced in quantities suitable for direct seeding. Most of the site will be sown with a woodland mix, and, as outlined above, riparian species will be targeted towards areas with higher water retention. Once initial vegetation is established the biodiversity can be further increased with shade tolerant species either through direct seeding or planting of tube stock.

## Seed collecting

All of the plants on the revegetation seed list grow in the local area and can be harvested in varying quantities. However, each species has a different flowering and fruit ripening time and so seed collection must be the first priority if there is to be enough seed available for direct seeding. Seed will be harvested as much as possible from the Wambo Mine Conservation lands and grazing properties adjoining the creek diversion site. If more seed is required it will be harvested from the Hunter Valley area, prioritising the Wollombi Brook catchment in order to select the plant genetics best suited to the site and local conditions. If sowing is to commence in summer-autumn of 2020 then seed collection activities should start no later than September 2019 to allow sufficient time to collect as many target species as possible. This is because each species has a different flowering and seed-ripening time and often the window between seed ripening and dropping from the plant can be quite short.

It may not be possible to collect all the species on the revegetation list but as many species as possible from each of the types of vegetation should be sourced. Final seed mixes should meet or exceed diversity values as compared to target vegetation benchmark values.



Native seed blended for broadcasting

## Direct seeding methods

Various methods exist for sowing native seed – e.g. broadcasting, drilling, hydroseeding. Given the size and topography of the site a combination of broadcasting and hydroseeding are considered the most appropriate. The majority of the site can be sown using broadcasting techniques but in some steep areas prone to erosion hydroseeding could be used, particularly in conjunction with hydromulch applications. These methods may be required due to lack of access for conventional seedbed preparation and the need for added stability in these zones.



Aerator preparing ground for sowing, Jerry's Plains NSW

## Mechanical broadcasting/ Hand broadcasting

Seed broadcasting can be done over large areas using tractors and appropriate agricultural implements e.g. spreader, air seeder, seed blower. Small inaccessible areas can be sown by hand to good effect.

For any given area the following procedure should be followed to maximise success:

- > **Soil analysis** and interpretation of results
- > **Soil amelioration** according to the interpretation of soil test results and need to be matched to the requirements of the native species selected, otherwise amelioration may be counterproductive.
  - Soil ameliorants may include, amongst others, gypsum, compost, mulch or microbial inoculants
- > **Cultivation**
  - Deep ripping or chisel ploughing may be required to break up compacted soil (depending on depth).
  - Cultivation will usually be required to properly incorporate soil ameliorants
  - Cultivation should be conducted in such a way as to protect the soil from erosion – i.e. rip along contours, avoid leaving wheel tracks, reduce preferential water flow channels at all times.
  - Aerators are particularly useful for providing a pattern of small pockets which limits preferential flow channels and should be used to leave such a pattern post sowing.
- > **Weed Control**
  - Weed control should be timed to provide bare ground for the sowing date. Perennial weeds may require multiple spray events for effective control.
- > **Final seedbed preparation**
  - A suitable seedbed will have niches available for seed to fall and be covered by soil
  - Preferential flow channels must be avoided to maintain a stable surface so that seed is not washed away during rain events
  - Soil condition should be friable so that good seed-soil contact can be made

> **Species mix selection and blending**

- Seed mixes should be blended according to the requirements of each area. High bank mixes should be different to those used on the bank toe or in areas of potential ponding. Consideration should also be given to changes in soil chemistry and texture. The site should be mapped prior to sowing based on soil type, topography and predicted waterflows and seed blends developed for each area.

> **Sowing**

- Seed should be sown when conditions are likely to be most favourable for germination – i.e. when soil temperatures are high and rainfall is predicted. In the Hunter Valley the best time for sowing is usually February-April in anticipation of late summer storm events.

> **Maintenance**

- Maintenance activities should focus on competition from perennial weeds which have the highest competitive impact on native seedlings. These weeds are likely to include *Chloris gayana* – Rhodes Grass, *Panicum maximum* var. *trichoglume* – Green Panic, *Eragrostis curvula* – African Lovegrass, *Cynodon dactylon* – Couch Grass and *Galenia pubescens* – Galenia.
- Annual weeds present in the soil seedbank usually emerge on freshly sown sites although they are of lower concern and should only be controlled if present in very high density and are competing too strongly with emerging natives. In many cases annual weeds provide benefits to the native plants such as protection from sun and wind, nutrient cycling and increasing soil organic matter.
- Timely repair of any emerging erosion issues will also be important.



Ground prepared for sowing, Camden Lakeside Golf Course NSW

## Hydromulching/Hydroseeding in steep or inaccessible areas

Application of seed using a hydroseeding machine either with or without mulch, soil ameliorants or soil stabilisation polymers can be useful in steep or otherwise unstable sites. The site preparation using this technique is just as important as in broadcasting. Hydromulches may provide a growth medium for native species on slopes where it is impossible to fully prepare a seed bed. However, we cannot rely solely on the mulch as a growing medium and attention must be paid to the underlying soil surface. It may be necessary to increase surface roughness and therefore niches for seed germination. Creating furrows or pockets using hand tools or machinery can significantly increase water harvesting and soil stability and therefore the success of revegetation efforts.

The same steps as above are required. See previous section for more detail as required:

- > **Soil analysis** and interpretation of results
- > **Soil amelioration** according to the interpretation of soil test results
  - Soil ameliorants may include, amongst others, gypsum, lime, compost, mulch or microbial inoculants
- > **Cultivation**
  - Cultivation in areas to be hydroseeded may not be possible to the same extent because of steep slopes or inaccessible areas. Efforts should be made, however, to shape the slope topography so as to increase surface roughness and reduce soil crusting.
- > **Weed Control**
  - Weed control should be timed to provide bare ground for the sowing date. Perennial weeds may require multiple spray events for effective control.
- > **Final seedbed preparation**
  - A suitable seedbed will have niches available for seed to fall and be covered by soil
  - Preferential flow channels must be avoided to maintain a stable surface so that seed is not washed away during rain events
- > **Species mix selection and blending**
  - Many native species are suitable for use in a hydroseeding application. The process for species selection is the same as for broadcasting.
- > **Sowing**
  - Seed should be sown when conditions are likely to be most favourable for germination – i.e. when soil temperatures are high and rainfall is predicted. In the Hunter Valley the best time for sowing is usually February-April in anticipation of late summer storm events.
  - Seed can be sown (hydroseeded) directly onto the soil surface and then hydro mulch and other products can be applied in a second pass, or seed can be blended with mulch and applied in a single pass. Both techniques should be trialled in areas which have been identified for hydromulch application.



Natives germinated among exotic annuals

### > Maintenance

- Maintenance activities should focus on competition from perennial weeds which have the highest competitive impact on native seedlings. These weeds are likely to include *Chloris gayana* – Rhodes Grass, *Panicum maximum* var. *trichoglume* – Green Panic, *Eragrostis curvula* – African Lovegrass, *Cenchrus clandestinus* – Kikuyu, *Cynodon dactylon* – Couch Grass and *Galenia pubescens* – Galenia.

- Annual weeds present in the soil seedbank usually emerge on freshly sown sites but they are of lower concern and should only be controlled if present in very high density and are competing too strongly with emerging natives. In many cases annual weeds provide benefits to the native plants such as protection from sun and wind, nutrient cycling and increasing soil organic matter.
- Timely repair of any emerging erosion issues will also be important.

### Placing and seeding of erosion controls

Examples of possible sites (subject to assessment post re-shaping and hydrological assessment).

Treatment	Example locations (as per. Soil Conservation Service mapping locations)
Woodland	26
Riparian	22
Hydro-mulching/ Hydro-seeding	25, 29, 30
Salt tolerant vegetation	16
Timber and coir logs	31

Materials such as timber, coir logs, coarse mulch and jute mesh can be used to help control soil erosion and will enhance a revegetation project when increased soil stability is required. They also increase variety in a landscape, trapping moisture and other resources to provide niches for seed germination and protection for young plants. To exploit this seed can be targeted to these areas, either using a hydroseeder or hand broadcasting method. Jute matting or other geotextile fabrics are less useful in direct seeding projects because the dense weave of the mat prevents germination and emergence of seedlings. These fabrics can be used in areas to be planted with tube stock.

- > **Timber and coir logs need to be pinned in place on steeper slopes.**
  - seed should be sown on the upslope side where moisture, soil and other resources will be trapped
- > **Jute mesh needs to be securely pinned in place.**
  - Seed should be sown before placing the jute mesh to ensure good seed-soil contact. The seedlings can emerge through the holes in the open weave of the mesh.
  - If seed is sown over jute mesh then a top dressing of soil may be necessary to provide seed soil contact.
- > **Coarse mulch will protect bare soil from rain-splash and sheet erosion (on shallow slopes).** It will increase soil organic matter and microbial activity and provide small niches for seed placement and germination. Mulch should not be spread thickly on sites to be direct seeded because it will prevent seed-soil contact and the mulch itself will not provide a suitable growing medium.

## Planting procedure

- > **Identify areas best suited** to use of tube stock. These areas will most likely have the following characteristics
  - Sites subject to high flow events where soil stability may be compromised
  - With relatively high water harvesting potential
  - Accessible for maintenance watering
- > **Tube stock** may also be useful in introducing small numbers of high-value species designed to increase overall species diversity when insufficient seed is available for direct seeding. E.g. threatened species.
- > **Soil analysis and interpretation of results**
- > **Soil amelioration** according to the interpretation of soil test results
  - Soil ameliorants may include, amongst others, gypsum, compost, mulch or microbial inoculants. Fertiliser may also be useful.
- > **Site preparation**
  - Deep ripping and/or surface cultivation may be necessary to reduce compaction and assist plant roots in quickly colonising the soil profile.
- > **Planting**
  - Planting should be timed to avoid the hottest part of the summer and to allow plants to settle in before there is a risk of severe frost.
  - Plants should be thoroughly watered before planting to ensure a saturated root ball.
  - care should be taken to dig appropriately sized planting holes and to avoid damaging root balls.
  - Fertiliser or plant tonic such as seaweed extract can help plants recover from planting shock
  - Tree guards and mulch can help with water retention and protect young plants from predation
- > **Initial watering**
  - Water plants in immediately after planting to thoroughly saturate the surrounding soil and collapse any air gaps.
- > **Maintenance watering**
  - Water as required according to the climatic conditions and to take advantage of rainfall.

## Site monitoring and performance criteria

Works planned for 2019 may be monitored and assessed against the following criteria, which are based on those found in the Wambo Mine Biodiversity Management Plan (BMP). Because of the trial nature of these works there may be a need to amend these criteria based on field observations and analysis of monitoring data following the works.

## Visual monitoring

Wandering transects should be conducted across the whole site in accordance with visual monitoring specified in the BMP. Observations should include:

- General site condition
- Presence of threatening weeds
- Rate of native establishment
- Soil surface condition and erosion
- Evidence of plant nutrition or toxicity problems
- Evidence of feral animals
- Disturbance from land management and other activities

## Landscape Function Analysis monitoring

Landscape Function Analysis (LFA) should be used as specified in the Wambo Mine Biodiversity Management Plan. LFA transects should be established at several locations along the creek diversion. LFA indices of Landscape Organisation (LOI), Stability (SI), Soil Infiltration (INFI) and Nutrient Cycling (NI) should be tracked over time and against reference site scores. All indices should increase over time until they meet or exceed the reference site scores.

Target scores as defined in the Wambo Mine BMP are as follows:

LOI	SI	INFI	NI
> 0.84	> 62	> 41	> 37

These target scores should be verified against data collected from reference sites at the same time as revegetation site monitoring. This will assist in interpreting results and accounting for variations in scores due to climatic factors and differences in field observation.

## Floristic monitoring

Monitoring should be conducted at several locations along the creek diversion. Several monitoring locations will be necessary to correctly characterise the vegetation performance.

Wambo BMP specified Vegetation Assessment method is BioMetric (OEH 2016). This method was developed for assessing established vegetation and it is difficult to assess the characteristics of early-stage rehab using only this methodology. So that potential problems and early success in vegetation establishment can be identified it would be useful to include a series of 1x1m quadrats along the monitoring transects specified in the BMP in addition to the BioMetric sampling.

In the early stages the focus should be on maintaining a high level of ground cover, both as live plants and litter. Perennial plant cover will provide the best protection for soil but in the early stages at least, and potentially for many years post sowing the low productivity at this site may mean that perennial vegetation cover will be limited. Increased soil and landscape stability could be achieved using coarse woody debris and other litter to protect against erosion, increase infiltration and provide habitat for micro and macro-organisms.

The following table outlines performance measures as tracked against benchmark value targets. Benchmark values (targets) are based on combination of Benchmark Values for River Red Gum/ River Oak riparian woodland wetland in the Hunter Valley and Narrow-leaved Ironbark– Grey Box – spotted gum shrub grass open forest of the central and lower hunter.

In addition to using the Benchmark values an additional measure should be added for the first 2-3 years post sowing: Plants/m<sup>2</sup> as measured by sampling 1x1m quadrats along a transect. This measurement will better quantify the native ground cover in the early stages of rehabilitation (i.e. when plants will be very small and will not contribute much to the %cover scores, even when numerous) and will assist in identifying potential issues with native plant recruitment.

Exotic plant cover should be measured both for total EPC and for total threatening weed cover (Rhodes Grass, Galenia, Green panic, Kikuyu, Couch, African Lovegrass).

Floristic performance measures vs target ecological community benchmark values.

Floristic performance measures vs target ecological community benchmark values			
Measure	Benchmark ranges	Recommended (years 1-2) Following years should show further improvement towards benchmark values.	Recommended 5-25 years all measures tracking towards benchmark values. Native ground cover scores should be maintained at 30-60%, assuming shrub and canopy layer values are tracking well.
NPS	Native plant species richness	38-41	
NOS – Native Overstorey Cover	10-50%	0-5%	
NMS – Native - Cover	10-50%	5%	
NGCG – Native Ground Cover - Grass	30-60%	20-40%	
NGCS – Native Ground Cover - shrub	5-10%	5-20%	
NGCO – Native Ground cover - Other	20-40%	10-20%	
EPC – Exotic plant cover	<10% <sup>1</sup> .	<30%	
OR – Proportion of overstorey spp. regenerating	1	N/A	
HBT – Hollow bearing trees (in quadrat)	0.1-1	N/A	
FL – Fallen logs (length in quadrat)	10-35	N/A	
Additional measures			
Native plants / m <sup>2</sup>	N/A	15-20 <sup>2</sup> .	5-10
EPC for threatening weeds	<5%	<20%	<5%

1. Exotic annuals will often increase the EPC score at times but this is usually a temporary problem. The focus of this measure should be on exotic perennial weeds.
2. This measure is not expected to increase after the first 2 years as individual plants should increase in size. Further it will probably decline over time as mature plants won't be supported at this density in a dry climate.





Native grasses and herbs established. Camden Lakeside Golf Course

### Trigger Action Response Plans

The trigger action response plan listed in the Wambo Mine BMP is quite appropriate for setting the trigger levels for this project. Please refer to the BMP for further details. There are some minor changes that are recommended.

In the BioMetric Assessment section (Section 5.1 of the BMP) actions are triggered when some of the floristic attributes are above the target ranges. For example a Native Ground Cover – Grasses (NCGC) score above 150% of the target range requires action. In the first 2-5 years of vegetation establishment a NCGC of 150% of the target (Benchmark 30-60% cover) would be a good result, provided that grasses were not excluding tree and shrub species. The same would be the case for the other ground cover scores. Colonising grasses and saltbushes often dominate in newly rehabilitated land, and as long as trees, shrubs and herbs have also managed to germinate, these species will tend to decline in cover over time.

Tree and shrub cover at too high a density is more of a problem, as dense woody vegetation tends to exclude ground cover species in rehab situations due to light interception and competition for moisture. This can lead to a loss of grassy woodland cover and diversity and bare soil patches which are then prone to erosion. In such cases it may be necessary to thin the vegetation to maintain a suitable ground cover.

Any management actions identified by the Trigger Action Response Plan process should be based on careful assessment of the data gathered in the monitoring program.

## Appendix 1. Revegetation species list

Trees			Available in CPS seedbank
Angophora	floribunda	riparian	
Casuarina	glauca	riparian	
Casuarina	cunninghamiana	riparian	Yes
Corymbia	maculata	woodland	
Eucalyptus	tereticornis	riparian/ woodland	Yes
Eucalyptus	dawsonii	woodland	
Eucalyptus	moluccana	woodland	Yes
Eucalyptus	crebra	woodland	Yes
Eucalyptus	melliodora	woodland	Yes
Eucalyptus	fibrosa	woodland	
Shrubs/small trees			
Acacia	decora	woodland	Yes
Acacia	decurrens	woodland	
Acacia	falcata	woodland	Yes
Acacia	filicifolia	woodland	
Acacia	implexa	woodland	Yes
Acacia	leiocalyx	woodland	
Acacia	salicina	woodland	
Acacia	amblygona	woodland	
Acacia	cultriformis	woodland	
Allocasuarina	littoralis	woodland	
Allocasuarina	leuhmanii	woodland	
Bursaria	spinosa	woodland	Yes
Cassinia	quinquefaria	woodland	
Indigofera	australis	woodland	Yes
Melaleuca	decora	riparian / woodland	
Melaleuca	linariifolia	riparian	Yes
Notolaea	microcarpa	woodland	Yes
Grasses			
Aristida	ramosa	woodland	Yes
Austrodanthonia	spp.	woodland	Yes
Austrostipa	ramosissima	riparian / woodland	
Austrostipa	scabra	woodland	Yes
Grasses			

Bothriochloa	decipiens	woodland	Yes
Capillipedium	spicigerum	riparian / woodland	
Chloris	truncata	woodland	Yes
Chloris	ventricosa	woodland	Yes
Cymbopogon	refractus	woodland	Yes
Dichanthium	sericeum	woodland	Yes
Digitaria	divaricatissima	woodland	Yes
Digitaria	brownii	woodland	Yes
Microlaena	stipoides	riparian / woodland	Yes
Paspalidium	brevifolium	woodland	Yes
Poa	sieberiana	riparian / woodland	Yes
Themeda	triandra	woodland	Yes
<b>Sedges</b>			
Carex	apressa	riparian	Yes
Cyperus	exaltatus	riparian	Yes
Gahnia	aspera	riparian/ woodland	Yes
Juncus	usitatus	riparian	Yes
Juncus	subsecundus	riparian	
Juncus	subglaucus	riparian	
Juncus	prismatocarpus	riparian	
Lomandra	longifolia	riparian	Yes
<b>Herbs/ Saltbushes</b>			
Atriplex	semibaccata	woodland	Yes
Calotis	lappulacea	woodland	Yes
Calotis	cuneifolia	woodland	
Einadia	trigonos	woodland	
Einadia	hastata	woodland	Yes
Einadia	polygonoides	woodland	
Enchylaena	tomentosa	woodland	
Glycine	tabacina	woodland	
Glycine	clandestina	woodland	
Hardenbergia	violacea	woodland	Yes
Persicarea	decipiens	riparian	Yes
Vittadinia	cuneata	woodland	
Vittadinia	sulcata	woodland	

## Appendix 2. References

Wambo Coal Mine Biodiversity Management Plan, 2018, Peabody Energy  
Surface Water Technical Report for South Bates Underground Mine Extraction Plan  
(Longwalls 11 to 16) 2016, Alluvium.

[www.bom.gov.au/](http://www.bom.gov.au/) 2019 Bureau of Meteorology.

<http://plantnet.rbgsyd.nsw.gov.au/> 2019, NSW Herbarium

<https://avh.ala.org.au/occurrences/search>, 2019, Australasian Virtual Herbarium

## 10. Appendix B – Soil Tests

**Biosecurity Laboratory Operations**

**Environmental Laboratory**

**1243 Bruxner Highway, WOLLONGBAR NSW 2477**

Phone: 02 6626 1103 Email: wollongbar.csu@dpi.nsw.gov.au

Taresa Hateley  
Soil Conservation Service  
709 Gundy Road  
SCONE NSW 2337

## Soil Analysis Report

4 sample(s) of soil received on 18/07/19. Tested as per the following methods.

Testing commenced 18/07/19

Method	Method Description
S202	Soil Electrical Conductivity
S201	Soil pH in 1:5 water or 1:5 CaCl <sub>2</sub> suspension
S262	Colwell, Bicarbonate Extractable Phosphorus in soil by FIA
S273	Gillman & Sumpter Exchangeable Cations

\*\* Where shown, indicates NATA accreditation does not cover the performance of this service.

**Results relate only to the items tested.**

**Notes:** As requested, testing for physical analysis will be performed by SESL.

- When required, samples air dried at 40°C as per Soil Chemical Methods - Australasia (Rayment and Lyons 2011).
- Results are expressed on an air-dry weight basis unless otherwise stated.
- Physical soil testing results are calculated on 105°C dry weight.
- This report should not be reproduced except in full.
- Samples will be retained for one calendar month from the date of the final report. Samples will then be discarded.
- Clients wishing to recover their samples must contact the laboratory within this period. This laboratory will return residual samples at client expense.

Date of issue 31/07/19

Laboratory No. Client's ID	Units	Limit of Reporting	1 SS.1 0-20	2 SS.1 20-60	3 SS.2 0-60	4 SS.3 0-30
<b>Miscellaneous Analysis</b>						
Electrical Conductivity	dS/m	0.0010	0.056	0.26	0.74	0.36
pH (Water)	pH units	0.04	6.3	7.5	8.3	8.9
pH (CaCl <sub>2</sub> )	pH units	0.04	5.4	6.6	7.0	8.0
Colwell Phosphorus	mg/kg	2.0	6.2	6.2	7.5	9.1
<b>Exchangeable Cations</b>						
Aluminium	cmol(+)/kg	0.10	<0.1	<0.1	<0.1	<0.1
Calcium	cmol(+)/kg	0.030	5.6	3.3	1.6	1.1
Potassium	cmol(+)/kg	0.010	0.62	0.82	0.70	0.56
Magnesium	cmol(+)/kg	0.0070	2.3	4.7	4.4	3.5
Sodium	cmol(+)/kg	0.030	0.39	2.4	5.1	1.6
CEC (effective)	cmol(+)/kg	0.20	8.9	11	12	6.7
Calcium/ Magnesium			2.5	0.70	0.37	0.31
Percent Aluminium Saturation	% of ECEC		N/A	N/A	N/A	N/A
Exchangeable Calcium	% of ECEC		63	29	14	16
Exchangeable Potassium	% of ECEC		6.9	7.3	5.9	8.4
Exchangeable Magnesium	% of ECEC		26	42	37	51
Exchangeable Sodium Percentage	% of ECEC		4.4	22	43	24



## Clay Content Assessment

**Sample Drop Off:** 16 Chilvers Road  
Thornleigh NSW 2120

**Tel:** 1300 30 40 80  
**Fax:** 1300 64 46 89

**Mailing Address:** PO Box 357  
Pennant Hills NSW 1715

**Em:** info@sesl.com.au  
**Web:** www.sesl.com.au

**Client Name:** NSW Department of Primary Industries (NSW DPI)

**Project Name:** WN190709

**Client Contact:** Amanda Musgrave

**SESL Quote N°:** Q10056

**Client Order N°:**

**Sample Name:** WN190709-1

**Address:** 1243 Bruxner Highway  
Wollongbar NSW 2477

**Description:** Soil

**Test Type:** Texture\_SESL, EAT, PSA\_SC, Disp\_PER, USCS\_SESL

Batch N°	Sample N°	Sample Name	Description	Clay Content (%)
53734	1	WN190709-1	Soil	5.34
53734	2	WN190709-2	Soil	21.01
53734	3	WN190709-3	Soil	13.83

### SUMMARY AND RECOMMENDATIONS

Analysed by SESL Australia Pty Ltd, NATA # 15633  
Recommendations by SESL Australia not requested.

**Consultant:** Michelle Murphy

**Authorised Signatory:** Michelle Murphy

**Report Status:**

Final





### Multiple Analysis Profile

**Sample Drop Off:** 16 Chilvers Road **Tel:** 1300 30 40 80  
Thornleigh NSW 2120 **Fax:** 1300 64 46 89  
**Mailing Address:** PO Box 357 **Em:** info@sesl.com.au  
Pennant Hills NSW 1715 **Web:** www.sesl.com.au

Tests are performed under a quality system certified as complying with ISO 9001: 2008. Results and conclusions assume that sampling is representative. This document shall not be reproduced except in full.

<b>Batch N°: 53734</b>	<b>Sample N°: 1</b>	<b>Date Instructions Received: 31/7/19</b>	<b>Report Status: Final</b>
Client Name: <b>NSW Department of Primary Industries (NSW DPI)</b>	Project Name: <b>WN190709</b>	SESL Quote N°: <b>Q10056</b>	
Client Contact: <b>Amanda Musgrave</b>	Sample Name: <b>WN190709-1</b>	Description: <b>Soil</b>	
Client Order N°:	Test Type: <b>Texture_SESL, EAT, PSA_SC, Disp_PER, USCS_SESL</b>		
Address: <b>1243 Bruxner Highway Wollongbar NSW 2477</b>			

Analysis	Unit	Result
Texture	--	Sandy loam
Emerson Aggregate Class (EAT)	--	Class 8
Clay Dispersion	%	SW - Well graded clean sands (<5% fines), gravelly sands, little or no fines.
USCS	--	5.56

Analysed by SESL Australia Pty Ltd, NATA # 15633  
Recommendations by SESL Australia not requested.

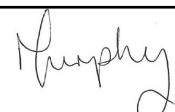
Consultant:   
Michelle Murphy

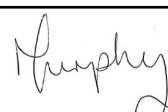
Authorised Signatory:   
Michelle Murphy

Date Report Generated  
7/08/2019



**Multiple Analysis Profile**

**Sample Drop Off:** 16 Chilvers Road  
 Thornleigh NSW 2120  
**Mailing Address:** PO Box 357  
 Pennant Hills NSW 1715  
**Tel:** 1300 30 40 80  
**Fax:** 1300 64 46 89  
**Em:** info@sesl.com.au  
**Web:** www.sesl.com.au

Tests are performed under a quality system certified as complying with ISO 9001: 2008. Results and conclusions assume that sampling is representative. This document shall not be reproduced except in full.

<b>Batch N°:</b> 53734	<b>Sample N°:</b> 2	<b>Date Instructions Received:</b> 31/7/19	<b>Report Status:</b> Final
<b>Client Name:</b> NSW Department of Primary Industries (NSW DPI)	<b>Project Name:</b> WN190709	<b>SES L Quote N°:</b> Q10056	
<b>Client Contact:</b> Amanda Musgrave	<b>Sample Name:</b> WN190709-2	<b>Description:</b> Soil	
<b>Client Order N°:</b>	<b>Test Type:</b> Texture_SESL, EAT, PSA_SC, Disp_PER, USCS_SESL		
<b>Address:</b> 1243 Bruxner Highway Wollongbar NSW 2477			

Analysis	Unit	Result
Texture	--	Sandy loam
Emerson Aggregate Class (EAT)	--	Class 5
Clay Dispersion	%	SC - Sands with fines, (>12%); clayey sands, sand-clay mixtures.
USCS	--	59.9

Consultant:   
 Michelle Murphy

Authorised Signatory:   
 Michelle Murphy

Date Report Generated  
 7/08/2019



### Multiple Analysis Profile

**Sample Drop Off:** 16 Chilvers Road  
Thornleigh NSW 2120

**Tel:** 1300 30 40 80  
**Fax:** 1300 64 46 89

**Mailing Address:** PO Box 357  
Pennant Hills NSW 1715

**Em:** info@sesl.com.au  
**Web:** www.sesl.com.au

Tests are performed under a quality system certified as complying with ISO 9001: 2008. Results and conclusions assume that sampling is representative. This document shall not be reproduced except in full.

<b>Batch N°:</b> 53734	<b>Sample N°:</b> 3	<b>Date Instructions Received:</b> 31/7/19	<b>Report Status:</b> Final
<b>Client Name:</b> NSW Department of Primary Industries (NSW DPI)		<b>Project Name:</b> WN190709	
<b>Client Contact:</b> Amanda Musgrave		<b>SESL Quote N°:</b> Q10056	
<b>Client Order N°:</b>		<b>Sample Name:</b> WN190709-3	
<b>Address:</b> 1243 Bruxner Highway Wollongbar NSW 2477		<b>Description:</b> Soil	
		<b>Test Type:</b> Texture_SESL, EAT, PSA_SC, Disp_PER, USCS_SESL	

Analysis	Unit	Result
Texture	--	Sandy loam
Emerson Aggregate Class (EAT)	--	Class 5
Clay Dispersion	%	SC - Sands with fines, (>12%); clayey sands, sand-clay mixtures.
USCS	--	44.3

Consultant:   
Michelle Murphy

Authorised Signatory:   
Michelle Murphy

Date Report Generated 7/08/2019



### Multiple Analysis Profile

**Sample Drop Off:** 16 Chivers Road  
Thornleigh NSW 2120  
**Mailing Address:** PO Box 357  
Pennant Hills NSW 1715

**Tel:** 1300 30 40 80  
**Fax:** 1300 64 46 89  
**Em:** info@sesl.com.au  
**Web:** www.sesl.com.au

Tests are performed under a quality system certified as complying with ISO 9001:2008. Results and conclusions assume that sampling is representative. This document shall not be reproduced except in full.

<b>Batch N°: 53734</b>	<b>Sample N°: 4</b>	<b>Date Instructions Received: 31/7/19</b>	<b>Report Status: Final</b>
<b>Client Name:</b> NSW Department of Primary Industries (NSW DPI)	<b>Project Name:</b> WN190709	<b>SES� Quote N°:</b> Q10056	
<b>Client Contact:</b> Amanda Musgrave	<b>Sample Name:</b> WN190709-4	<b>Description:</b> Soil	
<b>Client Order N°:</b>	<b>Test Type:</b> Texture_SESL, EAT		
<b>Address:</b> 1243 Bruxner Highway Wollongbar NSW 2477			

<b>Analysis</b>	<b>Unit</b>	<b>Result</b>
Texture	--	Sandy loam
Emerson Aggregate Class (EAT)	--	Class 5

Consultant: *Murphy*  
Michelle Murphy

Authorised Signatory: *Murphy*  
Michelle Murphy

Date Report Generated  
7/08/2019

# **APPENDIX E**

## **NORTH WAMBO CREEK SUBSIDENCE STRATEGY**



**WAMBO COAL  
NORTH WAMBO CREEK DIVERSION SUBSIDENCE  
RESPONSE STRATEGY – SBU AND **SBU EXTENSION** MINE**

Document No. WA-ENV-MNP-509.7  
March 2018

## Document Control

<b>Document No.</b>	WA-ENV-MNP-509.7
<b>Title</b>	North Wambo Creek Diversion Subsidence Response Strategy – SBU Mine
<b>General Description</b>	Responses to potential subsidence impacts on North Wambo Creek Diversion
<b>Document Owner</b>	Environment & Community Manager

## Revisions

Rev No	Date	Description	By	Checked	Signature
1	May 2016	Updated for SBU LW11-LW13	WCPL	SP	
2	July 2017	Revised to address DPE comments and incorporate LW14-16	WCPL		
3	March 2018	Revised following MOD17 approval for SBUEX (Longwalls 17-25)	WCPL		

## CONTENTS

<b>1.0 INTRODUCTION</b> .....	<b>4</b>
1.1 BACKGROUND .....	4
1.2 OVERVIEW OF PREDICTED IMPACTS - NORTH WAMBO CREEK DIVERSION ..	5
1.3 PURPOSE.....	5
1.4 SCOPE .....	6
<b>2.0 MANAGEMENT STRATEGIES</b> .....	<b>10</b>
2.1 MONITORING.....	10
2.2 MANAGEMENT RESPONSES .....	11
2.3 NWCD TRIGGER ACTION RESPONSE PLAN.....	12
<b>3.0 MONITORING AND REPORTING</b> .....	<b>14</b>
3.1 MONITORING.....	14
3.2 REPORTING.....	14
<b>4.0 AUDIT/REVIEW</b> .....	<b>14</b>
<b>5.0 RESPONSIBILITIES</b> .....	<b>14</b>
<b>6.0 REFERENCES</b> .....	<b>15</b>

### Tables

Table 1 Monitoring Program for NWCD .....	10
Table 2 Management Response Strategies for NWCD .....	11
Table 3 NWCD Trigger Action Response Plan .....	13
Table 4: NWCSRS Responsibilities .....	15

### Figures

Figure 1: Wambo Coal Regional Location .....	7
Figure 2 – Location of SBU LW11 to LW16 and SBUE LW17 to LW25 .....	8
Figure 3 – Location of SBU LW11 to LW16, LW17 to 20 and NWCD.....	9

## LIST OF ATTACHMENTS

**Attachment A** *Water Management Plan – South Bates (Whybrow Seam) Underground Mine Longwalls 11-16*



## 1.0 Introduction

### 1.1 Background

The Wambo Coal Mine (the Mine) is situated approximately 15 kilometres west of Singleton, near the village of Warkworth, New South Wales (**Figure 1**). The Mine is owned and operated by Wambo Coal Pty Limited (WCPL), a subsidiary of Peabody Energy Australia Pty Limited.

The South Bates (Whybrow Seam) Underground Mine is a component of the approved Wambo Coal Mine. The South Bates (Whybrow Seam) Underground Mine commenced in February 2016 and involves extraction of coal by longwall mining methods from the Whybrow Seam within Coal Lease (CL) 397 and Mining Lease (ML) 1594 (**Figure 2**).

The potential environmental impacts of the existing Wambo Coal Mine (including the approved South Bates [Whybrow Seam] Underground Mine) were assessed in the Wambo Development Project Environmental Impact Statement (the Wambo Development Project EIS) (WCPL, 2003). Development Consent DA 305-7-2003 for the Wambo Coal Mine was granted on 4 February 2004 by the then NSW Minister for Urban Affairs and Planning under Part 4 of the *NSW Environmental Planning and Assessment Act, 1979*.

An application to modify the Development Consent (DA 305-7-2003 MOD 15) was lodged in July 2015 to allow an extension to the South Bates Underground Mine to include three additional longwalls (Longwalls 14 to 16) in the Wambo Seam and was approved on 10 November 2015. The application was accompanied by the South Bates (Wambo Seam) Underground Mine Modification Environmental Assessment (WCPL, 2015).

Underground mining at North Wambo Underground Mine commenced in 2005 was completed in early 2016 with the completion of Longwall 8b. Underground mining operations moved to South Bates (Whybrow Seam) Underground Mine with the commencement of Longwalls 11 to 16 (approved as part of the Development Consent DA 305-7-2003).

The SBU Mine has an Extraction Plan for LW11 to LW16 (the Extraction Plan) that outlines the proposed management, mitigation, monitoring and reporting of potential subsidence impacts and environmental consequences from the secondary extraction of Longwalls 11 to 16 at the South Bates Underground Mine in the Whybrow and Wambo Seams.

In December 2017, the DP&E granted approval for Wambo Coal Mine to conduct secondary extraction of nine additional longwall panels (LW17 to LW25) in the Whybrow Seam of the South Bates Underground Extension (SBUE) area (DA 305-7-2003 MOD 17). An Extraction Plan is currently being prepared for longwall panels 17 to 20. The Extraction Plan will outline proposed management, mitigation, monitoring and reporting of potential subsidence impacts and environmental consequences.

## 1.2 Overview of Predicted Impacts - North Wambo Creek Diversion

Potential environmental consequences to the North Wambo Creek Diversion (NWCD)<sup>1</sup> above the Longwalls 11 to 16 from the Extraction Plan, include:

- In-channel ponding up to 1.4 metres (m) deep and up to 250 m long;
- Potential for increased scour (and associated suspended solids) prior to the implementation of scour protection works; and
- Potential for increased leakage from the North Wambo Creek Diversion prior to crack remediation works.

HydroSimulations (2015) estimates that increased leakage from the North Wambo Creek Diversion to the underground workings could be in the order of approximately 12.5 megalitres per day (ML/day) prior to remediation during periods of flow. Advisian notes that flows in excess of 10 ML/day can be expected on approximately 22 days per year, comprising events of 2 to 3 days duration.

An additional 120 m of the NWCD will be directly undermined by the SBUE area longwalls. Subsidence from mining is predicted to impact a small section of the NWCD in the north-eastern corner of Longwall 17 (refer to Figure 2), where a shallow pool estimated to be 0.1 m deep and 25 m long is predicted to form. Pools are an existing feature of the NWCD and therefore the small pool that is predicted to form as a result of mining of Longwall 17 is proposed to be retained and would possibly contribute to the local ecology of the area in the future. The adjoining floodplain near the upstream edge of the pool is the area most vulnerable to scour. Cracking of the surface soil and underlying rock is predicted (Advisian, 2016). Subsidence impacts are predicted to be similar to those observed at the adjacent Longwalls 11 to 16 (Resource Strategies, 2017).

Management and remediation measures to mitigate the risk of scour and leakage associated with Longwalls 11 to 16 are outlined in **Section 2**. Additional measures are currently being developed for the Extraction Plan for Longwalls 17 to 20. Following approval of this document, relevant measures will be included in the next revision the North Wambo Creek Subsidence Response Strategy (NWCSRS).

## 1.3 Purpose

The purpose of this revised NWCSRS is to provide monitoring and management response strategies as a result of subsidence impacts on the NWCD (**Figure 3**) from the subsequent underground mining operations at SBU for LW11 to LW16 and SBUE area LW17-20.

---

<sup>1</sup> North Wambo Creek has now been completely diverted around the active Bates South Open Cut Pit. The creek diversion is located adjacent to the finishing (i.e. north-eastern) ends of the proposed South Bates (Wambo Seam) Underground Mine Longwalls 14 to 16 (WMLW14 to WMLW16) and is partially located above the three longwalls in the Whybrow Seam, now referred to as WYLW11 to WYLW13 at the South Bates (Whybrow Seam) Underground Mine.

#### 1.4 Scope

The NWCSRS applies to all WCPL employees, contractors and sub-contractors, undertaking activities within the vicinity of North Wambo Creek Diversion, within WCPL's mining authorisations and approved mining areas. The North Wambo Creek Diversion is located adjacent to the proposed LW11 to LW16 and LW17 to LW20 as shown in **Figure 3**.

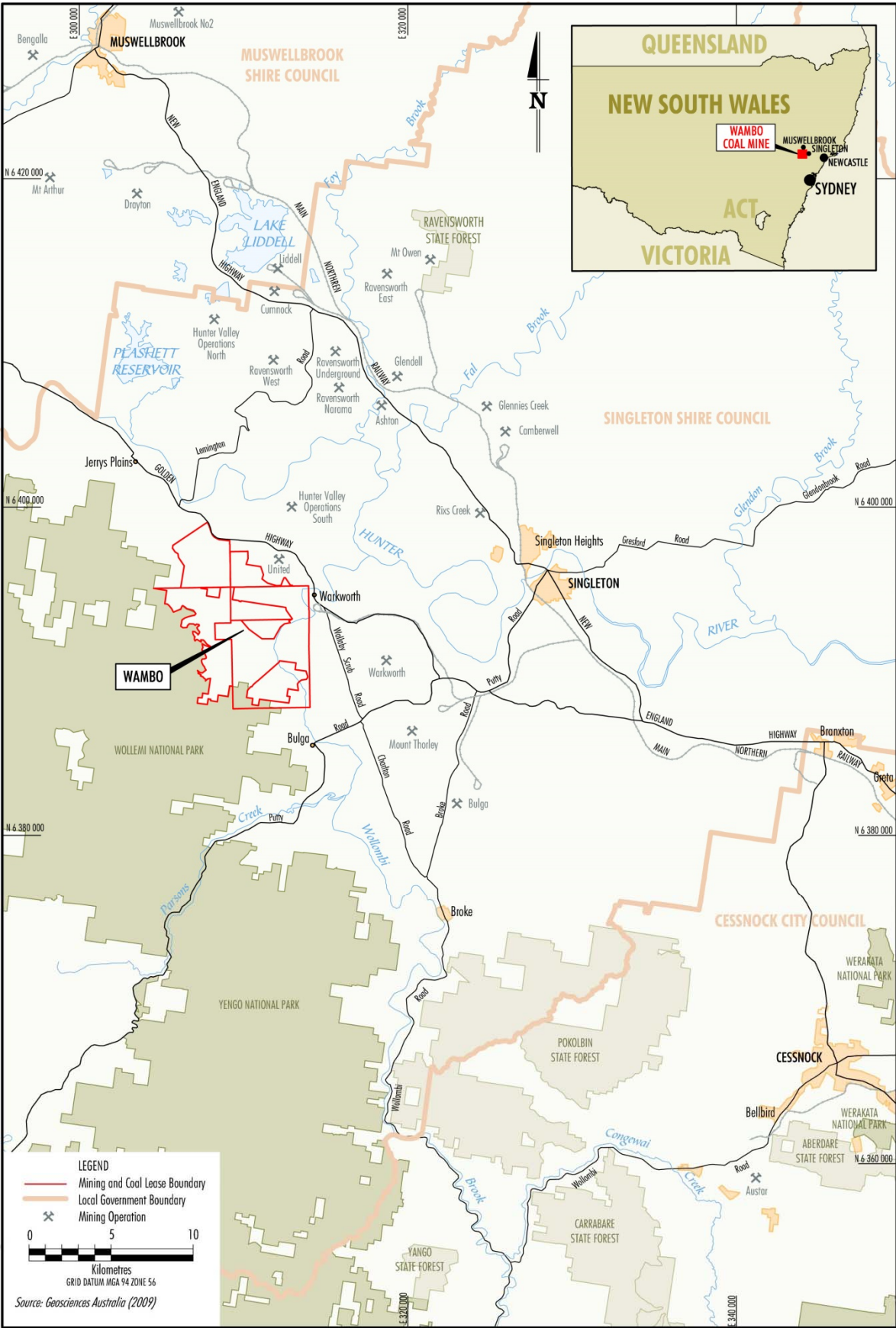

WAM-09-15\_EP Sth Bates\_Wambo Seam\_GW\_101A

Figure 1: Wambo Coal Regional Location

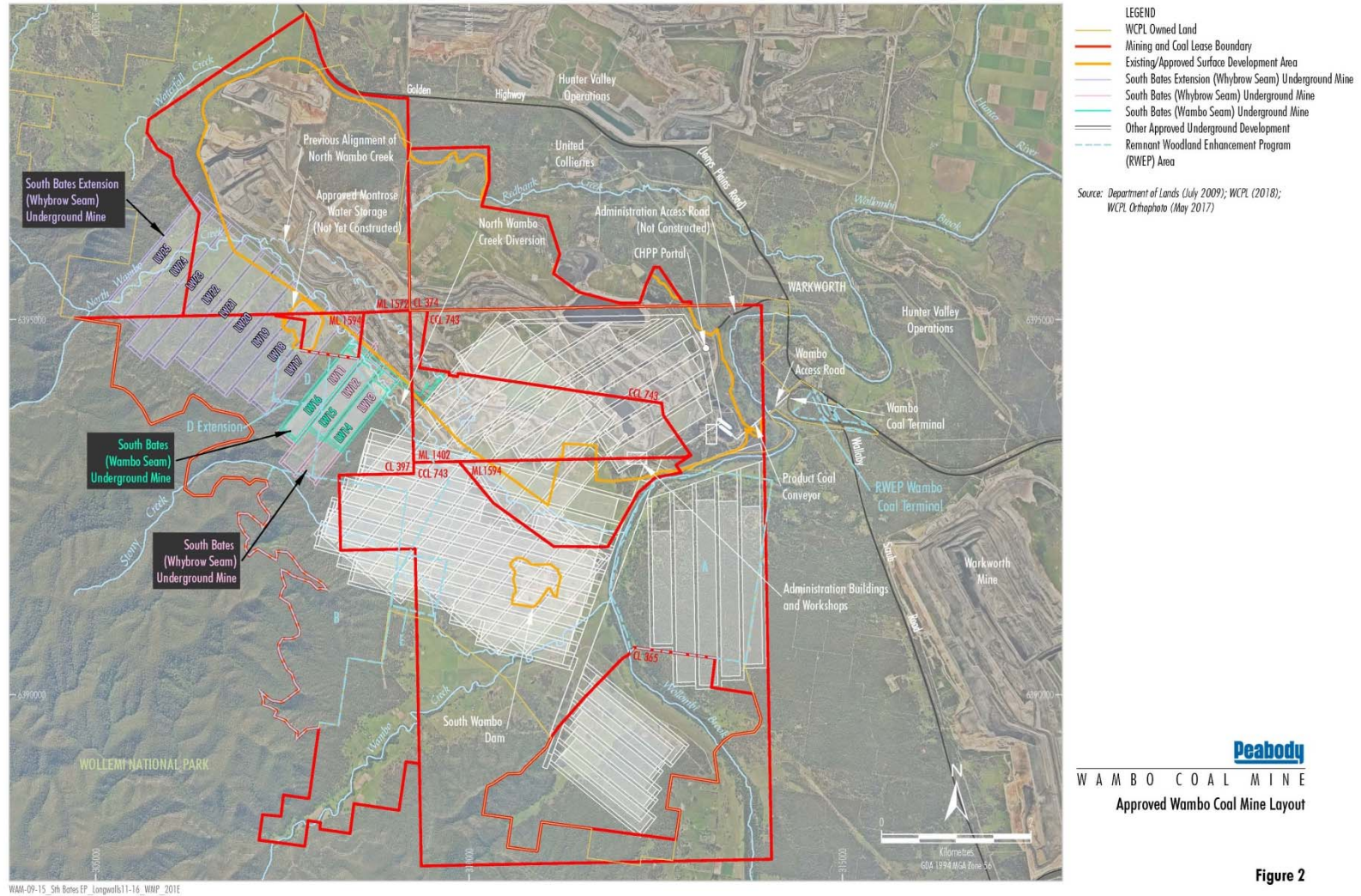

**Figure 2 – Location of SBU LW11 to LW16 and SBUE LW17 to LW25**

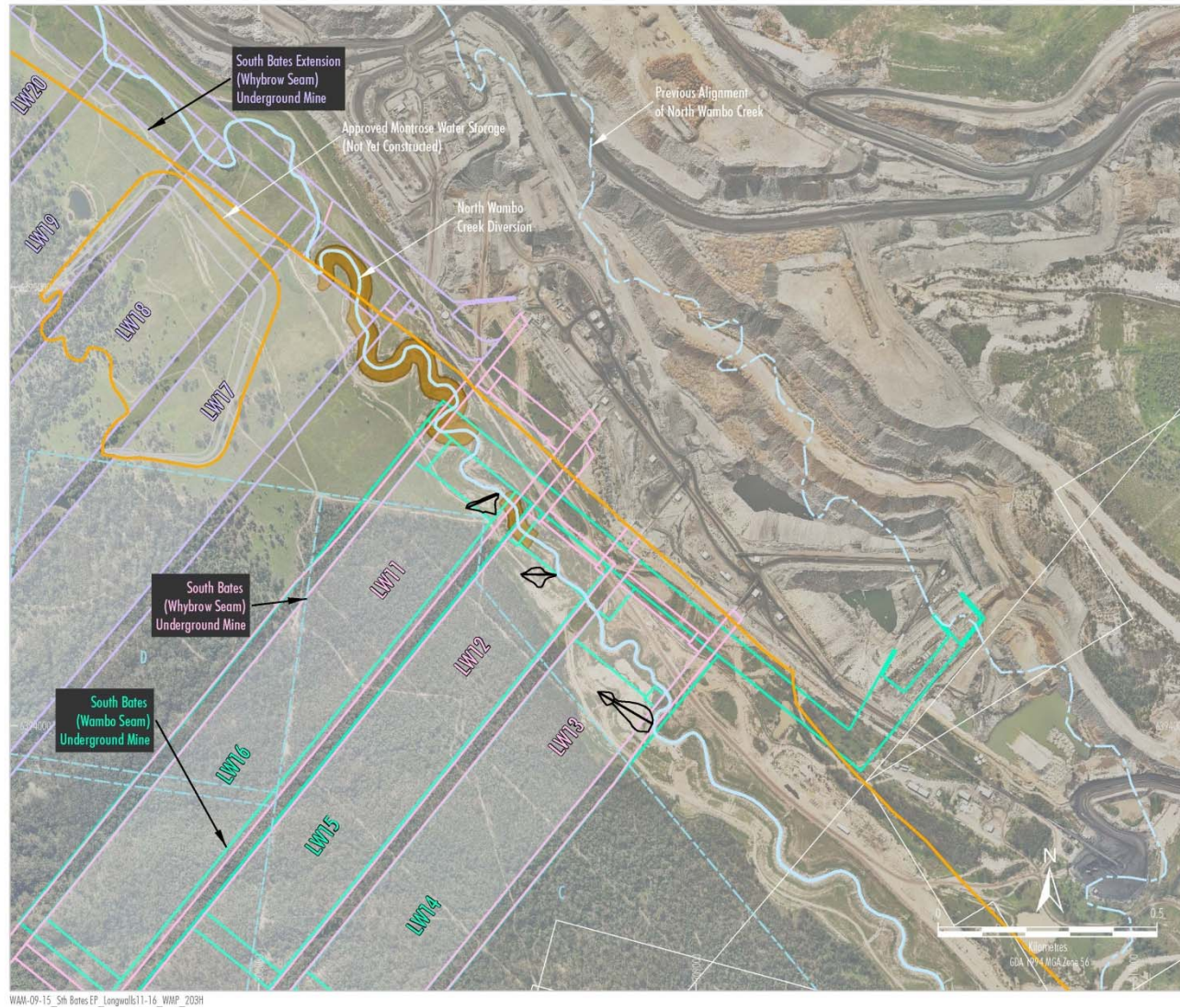

**LEGEND**

- Existing/Approved Surface Development Area
- South Bates Extension (Whybrow Seam) Underground Min
- South Bates (Whybrow Seam) Underground Mine
- South Bates (Wambo Seam) Underground Mine
- Other Approved Underground Development
- Remnant Woodland Enhancement Program (RWEF) Area
- Conceptual Location of Batter Chute
- Extent of Area that may require Stabilisation Measures

Source: Department of Lands (July 2009); WCPL (2018); WCPL Orthophoto (May 2017); Alluvium (2016)

**Peabody**  
 WAMBO COAL MINE  
 Aerial Photograph of  
 North Wambo Creek Diversion

**Figure 3**

**Figure 3 – Location of SBU LW11 to LW16, SBUE LW17 to LW20 and NWCD**

## 2.0 Management Strategies

### 2.1 Monitoring

The monitoring strategies to identify the proposed impacts within the NWCD as described in **Section 1** (from the Extraction) are detailed and summarised in **Table 1**.

**Table 1** Monitoring Program for NWCD

Monitoring Component	Parameter	Timing/Frequency	Responsibility
<b>Pre-Mining</b>			
Bed and bank stability monitoring of North Wambo Creek Diversion and Stony Creek.	In accordance with the SWMP.	In accordance with the SWMP.	Environment and Community Manager
Monitoring of surface water quality and flow monitoring sites (SW04, SW27a, SW08, FM2, FM3).	In accordance with the SWMP.	In accordance with the SWMP.	Environment and Community Manager
Monitoring of groundwater sites (GW21, N2, N3).	In accordance with the GWMP.	In accordance with the GWMP.	Environment and Community Manager
<b>During Mining</b>			
Longwalls 11 to 16 and LW17 to LW25 subsidence monitoring lines as described in the Subsidence Monitoring Program.	Monitoring parameters include: <ul style="list-style-type: none"> <li>• subsidence;</li> <li>• tilt;</li> <li>• tensile strain;</li> <li>• compressive strain; and</li> <li>• absolute horizontal translation.</li> </ul>	Monitoring during secondary extraction of Longwalls 11 to 16 and LW17, in accordance with the Subsidence Monitoring Program.	Mine Surveyor
Diversion and subsidence monitoring program.	As outlined in the SWMP.	In accordance with the SWMP.	Environment and Community Manager
Visual inspection of the North Wambo Creek Diversion.	Surface cracks. Surface ponding.	Daily inspections when extraction is occurring directly beneath North Wambo Creek Diversion.	Environment and Community Manager
Visual inspection of drainage line flow paths.	Evidence of erosion or channelisation.	Following a rainfall event of greater than 40 mm in 24 hours. <sup>1</sup>	Environment and Community Manager
Bed and bank stability monitoring of Stony Creek.	In accordance with the SWMP.	In accordance with the SWMP.	Environment and Community Manager
Monitoring of surface water quality and flow monitoring sites (SW04, SW27a, SW08, FM2, FM3).	In accordance with the SWMP.	In accordance with the SWMP.	Environment and Community Manager
Monitoring of groundwater sites (GW21, N2, N3).	In accordance with the GWMP.	In accordance with the GWMP.	Environment and Community Manager
Inflows to underground workings.	Dewatering volumes and underground water levels in accordance with the GWMP.	Recorded on a daily basis during pumping.	Environment and Community Manager

## 2.2 Management Responses

The management response strategies to address the proposed impacts within the NWCD as described in **Section 1** (from the Extraction Plan) are detailed and summarised in **Table 2**.

**Table 2** Management Response Strategies for NWCD

Management Measure	Timing/Frequency	Responsibility
<b>Pre-Mining</b>		
Stockpile sufficient materials and make equipment and necessary resources available for: <ul style="list-style-type: none"> <li>sealing any surface cracks (particularly in areas that are predicted to be ponded); and</li> <li>installation of scour protection works.</li> </ul>	Prior to commencement of secondary extraction of Longwalls 11 to 16 and 17 to 25.	Environment and Community Manager
Management Measure	Timing/Frequency	Responsibility
<b>During Mining</b>		
Remediation of all visible surface cracks in the North Wambo Creek Diversion low flow channel as soon as practicable. Cracks would be infilled with alluvial/colluvial material that may be blended with bentonite to achieve a level of seal consistent with the surrounding host material.	As soon as practicable following observation (nominally within two weeks).	Environment and Community Manager
Remediation of surface cracks <sup>1</sup> in areas outside the North Wambo Creek Diversion low flow channel where practicable using conventional earthmoving equipment (e.g. a backhoe) including: <ul style="list-style-type: none"> <li>infilling of surface cracks with soil or other suitable materials; or</li> <li>locally re-grading and re-compacting the surface.</li> </ul>	When required during secondary extraction of Longwalls 11 to 16 and 17 to 25.	Environment and Community Manager
Review of areas that may be vulnerable to scour along the North Wambo Creek Diversion (as shown on Figure 3) and installation of appropriate scour protection (e.g. vegetation planting, placement of woody debris, localised rock armouring).	The timing for installation of scour protection is currently being reviewed in consultation with external consultant.	Environment and Community Manager
Construction of new batter chutes to manage concentrated overland flow entry to the North Wambo Creek Diversion (see conceptual locations on Figure 3).	The timing for construction is currently being reviewed in consultation with external consultant.	Environment and Community Manager
Stabilisation of any areas of surface cracking or erosion using erosion protection measures (e.g. vegetation planting).	When required during secondary extraction of Longwalls 11 to 16 and 17 to 25.	Environment and Community Manager
Review of remediation measures and implementation of additional measures if required, in accordance with the TARP (Attachment 1).	Ongoing during mining.	Environment and Community Manager



**Table 2 Management Response Strategies for NWCD (cont..)**

<b>Post-Mining</b>		
Review of remediation measures and implementation of additional measures if required, in accordance with the TARP ( <b>Attachment 1</b> ).	Following completion of secondary extraction of Longwalls 11 to 16 and 17 to 25.	Environment and Community Manager
Post-subsidence assessment of impacts to Stony Creek and drainage lines and implementation of any minor remedial works.	Following completion of secondary extraction of Longwalls 11 to 16 and 17 to 25.	Environment and Community Manager

**Notes:** <sup>1</sup>

- Minor cracks that develop are not expected to require remediation as geomorphic processes will result in natural filling of these cracks over time;
- Remediate surface cracks as required by the MOP i.e.:
  - No subsidence surface cracks remaining that present a risk to the environment, safety and the final land use objectives; and/or
  - Remediation of surface cracks >50 mm.
- Remediation of surface cracks, where practicable using conventional earthmoving equipment (e.g. a backhoe) including:
  - Infilling of surface cracks with soil or other suitable materials; and
  - Locally re-grading and re-compacting the surface.
- Ensure sufficient stockpiles of suitable material (i.e. sandy-silt and/or alluvium material that has been confirmed by soil specialist) have been either placed or identified within the vicinity of the NCWD prior to longwall within the NWCD;
- Ensure equipment and necessary resources available for remediation prior to longwall within the NWCD;
- Whilst the methods of remediation would not be expected to change, infilling the larger surface cracking with cohesive materials and by regrading and re-compacting the surface soils; and
- WCPL will consider the addition of bentonite to the alluvial material used in crack remediation in the low flow channel (i.e. where the bedrock is exposed) based on geotechnical advice. The addition of bentonite could be beneficial due to its ultra fine particle size, expansive and sealing properties and could assist with the natural process of capturing fines. If required, a percentage of bentonite will be blended with the alluvial material where required to supplement its fines content to achieve a level of seal consistent with the surrounding host material.

### 2.3 NWCD Trigger Action Response Plan

A trigger action response plan (TARP) (**Table 3**) from the Extraction Plan has been developed if additional remediation measures and responses are required. **NOTE:** This TARP must be read in conjunction with the approved *Water Management Plan – South Bates (Whybrow Seam) Underground Mine Longwalls 11-16 (Appendix 1)*. **Table 3 will be reviewed following the approval of the Extraction Plan for LW17 to LW20.**

**Table 3 NWCD Trigger Action Response Plan**

Condition	Normal	Level 1	Level 2
	Normal Conditions	Management Measures	Restoration/Contingency Phase
<b>Trigger</b>	<ul style="list-style-type: none"> <li>No visible cracks along North Wambo Creek Diversion.</li> <li>Dewatering volumes and underground water levels at normal conditions and not significantly influenced by climatic conditions.</li> <li>Predicted impacts on other surface water and groundwater as described in <b>Section 3</b>.</li> </ul>	<ul style="list-style-type: none"> <li>Cracks observed along North Wambo Creek Diversion.</li> <li>Dewatering volumes and underground water levels are elevated and responding significantly to climatic conditions.</li> <li>Impacts requiring remediation observed on Stony Creek or other ephemeral drainage lines/overland flow paths.</li> <li>Groundwater or surface water impacts greater than expected.</li> </ul>	<ul style="list-style-type: none"> <li>Functionality of North Wambo Creek Diversion materially affected.</li> <li>Dewatering volumes and underground water levels continue to respond significantly to climatic conditions following remediation.</li> <li>The Wollombi Brook performance measure has been exceeded, or is likely to be exceeded.</li> </ul>
<b>Action</b>	<ul style="list-style-type: none"> <li>Conduct monitoring, consistent with <b>Tables 4 and 7</b>, the GWMP, SWMP and the Subsidence Monitoring Program (Appendix H of the Extraction Plan).</li> <li>Assess the environmental consequences of the subsidence in accordance with <b>Section 6</b> and the SGWRP.</li> <li>Assess the need for management measures in accordance with <b>Section 5</b> and the SGWRP.</li> </ul>	<ul style="list-style-type: none"> <li>Implement management measures, as required, in accordance with <b>Section 5</b> and the SGWRP.<sup>1</sup></li> <li>Continue monitoring, consistent with <b>Tables 4 and 7</b>, the GWMP, SWMP and the Subsidence Monitoring Program (Appendix H of the Extraction Plan).</li> </ul>	<ul style="list-style-type: none"> <li>Implement Contingency Plan described in <b>Section 7</b>.</li> <li>Develop action plan for additional measures, including consideration of: <ul style="list-style-type: none"> <li>additional scour protection, crack remediation and/or stabilisation; and/or</li> <li>isolation sealing of the diversion cutting, for example through injection grouting or installation of low permeability material.</li> </ul> </li> </ul>
<b>Frequency</b>	<ul style="list-style-type: none"> <li>Frequency consistent with <b>Table 5</b>, the GWMP, SWMP and SGWRP.</li> </ul>	<ul style="list-style-type: none"> <li>As required, in accordance with <b>Section 6</b> and the SGWRP.</li> </ul>	<ul style="list-style-type: none"> <li>As required, in accordance with <b>Section 7</b>.</li> </ul>
<b>Position of Decision Making</b>	<ul style="list-style-type: none"> <li>Environment and Community Manager.</li> </ul>	<ul style="list-style-type: none"> <li>Environment and Community Manager.</li> </ul>	<ul style="list-style-type: none"> <li>General Manager.</li> <li>Implementation of additional management measures will be undertaken in consultation with <b>DRG</b> and <b>CLWD</b>.</li> </ul>

<sup>1</sup> With regard to the specific circumstances of the subsidence impact [e.g. the location, nature and extent of the impact] and the assessment of environmental consequences, in accordance with **Sections 5 and 6** and the SGWRP.

Note: GWMP refers to the Wambo Coal Groundwater Monitoring Program.

SWMP refers to the Wambo Coal Surface Water Monitoring Program.

SGWRP refers to the Wambo Coal Surface Water Groundwater Response Plan.

DRG refers to the NSW Department of Environment and Planning - Division of Resources and Geoscience.

CLWD - refers to the Water division in the Department of Primary Industries, Crown Lands and Water

## 3.0 Monitoring and Reporting

### 3.1 Monitoring

Detailed longitudinal geomorphological surveys should be conducted along creek reaches affected by subsidence. The surveys should include a photographic record with location coordinates, with any areas of potential instability noted. Monitoring (as outlined in **Table 1**) should be undertaken:

- Prior to subsidence;
- During subsidence;
- Post subsidence; and
- Following the completion of any restoration or remediation works.

### 3.2 Reporting

All reporting requirements will be in accordance with Section 4.2 of the Extraction Plan. The reporting requirements include:

- Incident Reporting;
- Subsidence Management Status Report;
- Six Monthly Report; and
- Annual Review.

The Annual Review (AR) will include:

- Summary of subsidence effects monitoring and a comparison to predicted subsidence effects; and
- Summary of all environmental and subsidence monitoring results and a comparison of actual impacts with predicted subsidence impacts and the subsidence impact performance measures.

## 4.0 Audit/Review

The NWCSRS will be reviewed by the Environmental and Community Manager:

- On an annual basis;
- When there are changes to consent or licence conditions relating to aspects of this NWCSRS;
- In response to an Independent Environmental Audit conducted in accordance with Consent Condition 7, Schedule 6 of DA 305-7-2003;
- Following an incident at SBU in relation to water; or
- In response to a relevant change in technology or legislation.

## 5.0 Responsibilities

**Table 4** below summarises responsibilities documented in the NWCSRS. Responsibilities may be delegated as required.

**Table 4: NWCSRS Responsibilities**

No	Task	Responsibility	Timing
1	Subsidence monitoring as identified in <b>Section 2</b> of this Strategy.	Environmental and Community Advisor	As required
2	Implementation of mitigation strategies and monitoring measures in accordance with this Strategy and in consultation with relevant agencies.	Environment and Community Manager and Underground Manager	As required
3	Ensure that all process and procedures under this Strategy and all other relevant management plans in relation to this Strategy are followed.	Environment and Community Manager	As required
4	Ensure that all relevant personnel have reviewed the Strategy and any amendments.	Environment and Community Manager	As required
5	Ensure Strategy is implemented across all relevant personnel.	Environment and Community Manager	As required

## 6.0 References

- *Gilbert & Associates (2003) Wambo Development Project – Surface Water Assessment.*
- *Resource Strategies (January 2017) Extraction Plan – South Bates (Whybrow Seam) Underground Mine Longwalls 11 to 16;*
- *Resource Strategies (March 2017) Environmental Assessment for the Modification of DA305-7-2002 (MOD17) Extension of the Approved South Bates Mine*
- *SP Solutions (2006) Review of North Wambo Underground SMP Proposed Controls - North Wambo Creek.*
- *SCT Operations Pty Ltd (2015) Assessment of Inflow Potential Associated with Mining Under the North Wambo Creek Diversion.*
- *WCPL (2006) Wambo Coal Mine Modification Statement of Environmental Effects.*
- *WCPL (2015) South Bates (Wambo Seam) Underground Mine Modification Environmental Impact Statement.*
- *Water Management Plan – South Bates (Underground Mine Longwalls 11-16)*